

PERFORMANCE ANALYSIS OF COEXISTENCE SCHEMES FOR
LTE IN UNLICENSED BANDS

LIDA JABBARIARDEBILI

A THESIS SUBMITTED TO THE FACULTY OF GRADUATE STUDIES
IN PARTIAL FULFILMENT OF THE REQUIREMENTS
FOR THE DEGREE OF

MASTER OF APPLIED SCIENCE

GRADUATE PROGRAM IN COMPUTER SCIENCE AND ENGINEERING
YORK UNIVERSITY
TORONTO, ONTARIO
SEPTEMBER 2016

© LIDA JABBARIARDEBILI, 2016

Abstract

LTE in the unlicensed spectrum, is becoming a popular area of research. Since LTE-Unlicensed (LTE-U) provides subscribers with higher-quality mobile voice, and video experience in high-traffic or low-signal locations, a fair coexistence mechanism with other networks, like Wi-Fi is essential. In this thesis, we propose two coexistence mechanisms that could be employed to ensure a fair channel access. First, we consider coexistence mechanism fundamentals, and then downlink system performance of two coexistence mechanisms are analyzed for multi-operator LTE-Unlicensed (LTE-U) deployments with different simulation scenarios, using NS-3. First we introduce the most trustworthy coexistence mechanism, and then a high-performance coexistence scenario is provided. We conclude that Licensed Assisted Access (LAA) can coexist with Wi-Fi without impacting Wi-Fi more than an equivalent Wi-Fi network. In the second part, uplink performance evaluation of LTE in licensed spectrum is also demonstrated.

Dedication

To my parents, and my fiance. Thank you for everything.

Acknowledgements

First and foremost, I would like to express my sincere thanks to my supervisor, *Prof. Andrew Eckford*. Without his support, guidance and encouragement, this thesis would not have been written. He enlightened me on how to look research in its full depth and taught me how to create and appreciate a good scientific project that helps other researchers to build on it.

I would like to thank my supervisory committee members, *Profs. Uyen Trang Nguyen, Suprakash Datta, and Magdalena Krol*, whose insightful suggestions helped me to improve the quality of this thesis. I am also grateful to the graduate program team for their excellent administrative supports, *Prof. Richard Wildes, Prof. Yves Lesperance, Ouma Jaipaul-Gill, and Stefanie Lamonaca Caputo*.

I would also like to acknowledge many postgraduate fellows and friends who assisted me in so many ways during my time at York: Nariman Farsad, Linchen Wang.

Table of Contents

Abstract	ii
Dedication	iii
Acknowledgements	iv
Table of Contents	v
List of Tables	x
List of Figures	xi
Abbreviations	xv
1 Introduction	1
1.1 Motivations	3
1.2 Contributions	6
1.3 Thesis Structure	9

2	Literature Survey	10
2.1	Unlicensed LTE	11
2.2	Wi-Fi MAC Model	15
2.3	LTE and Wi-Fi Coexistence in Unlicensed Band	18
2.4	Wireless Unified Network	22
2.4.1	LTE-Unlicensed/Licensed Assisted Access	23
2.4.2	LTE and Wi-Fi Link Aggregation	26
2.4.3	LTE and Wi-Fi Link Aggregation and LTE-Unlicensed/Licensed Assisted Access	29
2.5	Thesis Overview	29
3	LTE-Unlicensed Supplementary Downlink (SDL) Coexistence with non-LBT	32
3.1	Channel Numbers for LTE-Unlicensed Bands	36
3.2	Coexistence Mechanisms without Listen-Before-Talk (LBT)	37
3.2.1	Channel Selection	39
3.2.2	Carrier-Sensing Adaptive Transmission	41
3.2.3	Opportunistic Supplementary Downlink (SDL)	43
3.2.4	LTE Blank Subframe Allocation	45
3.3	Experimental Results	49

3.3.1	Scenario and Methodology	49
3.3.2	Channel Access Schemes	54
3.3.3	Coexistence Results	57
3.4	Summary	65
4	Licensed Assisted Access (LAA) Supplementary Downlink (SDL)	
	Coexistence with LBT	70
4.1	Listen-Before-Talk (LBT) Overview	71
4.1.1	Frame Based Equipment(FBE) Scheme	72
4.1.2	Load Based Equipment(LBE) Scheme	74
4.2	Wi-Fi Listen-Before-Talk (LBT) Vs. European Load Based Equip- ment Listen-Before-Talk (EU LBE LBT)	76
4.2.1	Simulation Results	77
4.3	LTE modifications for Listen-Before-Talk (LBT)	81
4.3.1	Simulation Results	82
4.4	3rd Generation Partnership Project (3GPP) Listen-Before-Talk (LBT) Design	84
4.5	Experimental Results	86
4.5.1	Scenario and Methodology	87
4.5.2	Channel Access Scheme	91

4.5.3	Coexistence Results	92
4.6	Summary	113
5	Licensed Assisted Access (LAA) Uplink (UL) and Supplementary	
	Downlink (SDL) Coexistence with Listen-Before-Talk (LBT)	119
5.1	Downlink (DL) and Uplink (UL) Licensed Assisted Access (LAA)	
	Coexisting with Wi-Fi	120
5.1.1	Downlink (DL) Licensed Assisted Access (LAA) Coexisting	
	with Downlink (DL) Wi-Fi	123
5.1.2	Downlink (DL) Licensed Assisted Access (LAA) Coexisting	
	with Downlink (DL) and Uplink (UL) Wi-Fi	125
5.1.3	Downlink (DL) and Uplink (UL) Licensed Assisted Access	
	(LAA) Coexisting with Downlink (DL) and Uplink (UL) Wi-Fi	127
5.2	Adjacent Channel Interference (ACI)	128
5.2.1	Adjacent Channel Interference Ratio	129
5.3	Experimental Results	131
5.3.1	Scenario and Methodology	131
5.3.2	Coexistence Results	133
5.4	Summary	139
6	Conclusion and Future Work	142

List of Tables

3.1	Default experimental configurations	68
3.2	NS-3 parameters for 2-SC indoor scenario	69
4.1	NS-3 parameters for 4-SC indoor scenario	117
5.1	ACIR for different Wi-Fi and LAA scenarios [28].	130
5.2	NS-3 parameters for 2-SC indoor scenario with uplink	141

List of Figures

1.1	A typical Licensed-Assisted Access deployment [31].	2
2.1	Wi-Fi technological evolution [10].	12
2.2	IEEE 802.11 DCF channel access [20].	17
2.3	Successful data transmission by IEEE 802.11 [20].	17
2.4	LTE and Wi-Fi average user throughput [14].	21
2.5	LTE Licensed Assisted Access principle [18].	25
2.6	LWA architecture [18].	28
2.7	LTE-U, LAA, and LWA technologies [18].	29
3.1	5GHz unlicensed spectrum band plan [21].	34
3.2	3GPP LTE-U operation modes [22].	35
3.3	LTE-U coexistence mechanisms without LBT requirements [20].	38
3.4	LTE-U coexistence algorithms flow chart without LBT [23].	39
3.5	LTE-U SDL channel selection mechanism [23].	41

3.6	LTE-U CSAT function [23].	43
3.7	Collaborative coexistence procedure [25].	46
3.8	2-SC indoor scenario.	51
3.9	Basic LBT channel access design [29].	55
3.10	User throughput comparison.	58
3.11	Wi-Fi/LTE radio environment map (no coexistence solution).	59
3.12	Wi-Fi/LTE-U radio environment map.	60
3.13	LTE-U/LTE-U radio environment map.	61
3.14	Throughput evaluation of Wi-Fi/LTE-U for 2-SC in dense area.	63
3.15	Throughput evaluation of Wi-Fi/Wi-Fi for 2-SC in dense area.	64
3.16	Throughput evaluation of LTE-U/LTE-U for 2-SC in dense area.	65
3.17	DL overall throughput evaluation of different scenarios for 2-SC in dense area.	66
4.1	Frame Based Equipment (FBE) schedule [26].	72
4.2	LBT parameters for Frame Based Equipment (FBE) [26].	74
4.3	EU LBE LBT static backoff process [26].	75
4.4	LBT parameters for Load Based Equipment (LBE) [26].	76
4.5	Wi-Fi LBT exponential backoff process used by DCF [26].	77
4.6	Three simulation scenarios [26].	79

4.7	Successful transmissions of LBE LBT and Wi-Fi coexistence scenario [27].	80
4.8	DL median throughput gains in uniform scenario [23].	83
4.9	DL median throughput gains in cluster scenario [23].	84
4.10	4-SC indoor scenario [29].	88
4.11	Throughput evaluation of Wi-Fi/Wi-Fi for 2-SC in dense area. . . .	95
4.12	Throughput evaluation of Wi-Fi/LAA for 2-SC in dense area. . . .	96
4.13	Throughput evaluation of LAA/LAA for 2-SC in dense area.	97
4.14	DL overall throughput evaluation of different scenarios for 2-SC in dense area.	98
4.15	FTP Model 1 traffic [30].	102
4.16	Flow monitor output.	103
4.17	Throughput of Wi-Fi/Wi-Fi for 4-SC with FTP over UDP/IP [29].	105
4.18	Throughput of Wi-Fi/LAA for 4-SC with FTP over UDP/IP [29]. .	106
4.19	Latency of Wi-Fi/Wi-Fi for 4-SC with FTP over UDP/IP [29]. . . .	107
4.20	Latency of Wi-Fi/LAA for 4-SC with FTP over UDP/IP [29]. . . .	108
4.21	Throughput of Wi-Fi/Wi-Fi for 4-SC with FTP over TCP/IP [29].	109
4.22	Throughput of Wi-Fi/LAA for 4-SC with FTP over TCP/IP [29]. .	110
4.23	Latency of Wi-Fi/Wi-Fi for 4-SC with FTP over TCP/IP [29]. . . .	111
4.24	Latency of Wi-Fi/LAA for 4-SC with FTP over TCP/IP [29]. . . .	112

4.25	Achievable throughput of Wi-Fi/Wi-Fi for 4-SC with FTP over UDP/IP [29].	113
4.26	Achievable throughput of Wi-Fi/LAA for 4-SC with FTP over UDP/IP [29].	114
4.27	Achievable throughput of Wi-Fi/Wi-Fi for 4-SC with FTP over TCP/IP [29].	115
4.28	Achievable throughput of Wi-Fi/LAA for 4-SC with FTP over TCP/IP [29].	116
4.29	Wi-Fi/LAA radio environment map.	118
4.30	LAA/LAA radio environment map.	118
5.1	LAA using carrier aggregation [31].	121
5.2	LAA using LBT [31].	122
5.3	DL and UL throughput evaluation of LAA/LAA for 2-SC in dense area.	134
5.4	DL and UL overall throughput evaluation of LAA/LAA for 2-SC in dense area.	136
5.5	DL and UL throughput evaluation of Wi-Fi/LAA for 2-SC in dense area.	137
5.6	DL and UL overall throughput evaluation of Wi-Fi/LAA for 2-SC in dense area.	138

Abbreviations

3GPP	3rd Generation Partnership Project
ABS	Almost Blank Subframe
ACI	Adjacent Channel Interference
ACIR	Adjacent Channel Interference Ratio
ACLR	Adjacent Channel Leakage Ratio
ACS	Adjacent Channel Selectivity
AP	Access Point
BCCH	Broadcast Control Channel
BCH	Broadcast Channel
CA	Carrier Aggregation

CCA	Clear Channel Assessment
CCCH	Common Control Channel
CDMA	Code Division Multiple Access
CQI	Channel Quality Indicator
CSAT	Carrier Sensing Adaptive Transmission
CSI	Channel State Information
CSMA/CA	Carrier Sense Multiple Access with Collision Avoidance
CW	Contention Window
DCCH	Dedicated Control Channel
DCF	Distributed Coordination Function
DFS	Dynamic Frequency Selection
DIFS	Distributed Coordination Function Interframe Space
DL	Downlink
DL-SCH	Downlink Shared Channel
DTCH	Dedicated Traffic Channel

DTX	Discontinuous Transmission
eNB	Evolved NodeB
EARFCN	E-UTRA Absolute Radio Frequency Channel Number
E-UTRA	Evolved Universal Terrestrial Access
E-UTRAN	Evolved Universal Terrestrial Access Network
FBE	Frame Based Equipment
FCC	Federal Communications Commission
FDD	Frequency Division Duplex
FE	Frequency Element
GBR	Guaranteed Bit Rate (GBR)
HSPA	High Speed Packet Access
IEEE	Institute of Electrical and Electronics Engineers
IMT	International Mobile Telecommunications
ISM	Industrial, Scientific and Medical
ITU	International Telecommunication Union

LAA	Licensed Assisted Access
LBE	Load Based Equipment
LBT	Listen-Before-Talk
LTE	Long Term Evolution
LTE-A	Long Term Evolution-Advanced
LTE-U	Long Term Evolution-Unlicensed
MAC	Media Access Control
MCS	Modulation and Coding Scheme
MCCH	Multicast Control Channel
MCH	Multicast Channel
MIMO	Multiple Input Multiple Output
MTCH	Multicast Traffic Channel
NAS	Non Access Stratum Protocols
OFDM	Orthogonal Frequency-Division Multiplexing
OFDMA	Orthogonal Frequency-Division Multiple Access

PBCH	Physical Broadcast Channel
PCCH	Paging Control Channel
PCell	Primary Cell
PCFICH	Physical Control Format Indicator Channel
PCH	Paging Channel
PCF	Point Coordination Function
PDCCH	Physical Downlink Control Channel
PDCP	Packet Data Convergence Control
PDSCH	Physical Downlink Shared Channel
PHICH	Physical Hybrid ARQ Indicator Channel
PMCH	Physical Multicast Channel
PRACH	Physical Random Access Channel
PUCCH	Physical Uplink Control Channel
PUSCH	Physical Uplink Shared Channel
PHY	Physical layer

QCI	QoS Class Identifier
QoS	Quality of Service
RACH	Random Access Channel
RLC	Radio Link Control
R-PDCCH	Relay Physical Downlink Control Channel
RRC	Radio Resource Control
SC	Small Cell
SCell	Secondary Cell
SC-FDMA	Single-carrier Frequency-Division Multiple Access
SDL	Supplemental DownLink
SIFS	Short Interframe Space
TCP/IP	Transmission Control Protocol/Internet Protocol
TDD	Time Division Duplex
TD-SCDMA	Time Division Synchronous Code Division Multiple Access
TPC	Transmission Power Control

U-NII	The Unlicensed National Information Infrastructure
UE	User Equipment
UL	Uplink
UL-SCH	Uplink Shared Channel
WARP	Wireless Open-Access Research Platform
WCDMA	Wideband Code Division Multiple Access
WLAN	Wireless Local Area Network

1 Introduction

LTE in the unlicensed spectrum [1](LTE-U) or Licensed-Assisted Access [1](LAA) in general, is a radio access technology that has been proposed by Qualcomm to provide advanced wireless service in the 5GHz unlicensed band. While LTE-Unlicensed (LTE-U) or pre-Licensed Assisted Access (pre-LAA) is the term mostly used in North America by companies such as Qualcomm, Licensed Assisted Access (LAA) is the term mainly popular among European cell providers such as Ericsson.

Presently, mobile broadband data usage is expanding rapidly due to the unprecedented growth of wireless devices, especially smart phones. In [1], it is foreseen that mobile data traffic will boost exponentially from 2010 to 2020. Therefore, there is a vital need for a mature network, which can meet the rapidly growing data demand. Additional spectrum can address the hasty growing data demand reasonably. Since licensed spectrum is pricey, and limited in access, unlicensed spectrum has attracted researchers and operators due to the large amount of accessible spectrum. As an example, about 500MHz of spectrum are reachable by operators at the 5GHz band.

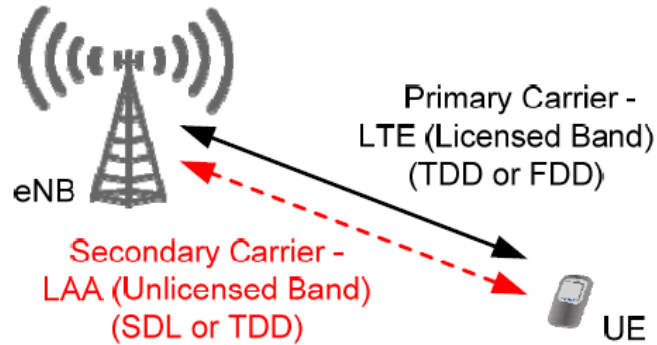

Figure 1.1: A typical Licensed-Assisted Access deployment [31].

On the one hand, there is a huge amount of spectrum available, but on the other hand, some regulations are essential, because, the large spectrum is shared by other systems or networks, such as Wi-Fi. Therefore, coexistence mechanism with other networks, like Wi-Fi, should be considered. It is worth mentioning that technologies which are already deployed in unlicensed band, like Wi-Fi, should not encounter much degradation in their performance while coexisting with an LTE-Unlicensed (LTE-U). Otherwise, an unplanned deployment of LTE-Unlicensed (LTE-U) may result in excessive radio frequency interference to the existing co-channel Wi-Fi and other LTE-Unlicensed (LTE-U) nodes in the neighborhood.

Carrier aggregation, which is the most important technology in LTE-Advanced, combines multiple radio frequency bands at the device to increase the data rates, capacity, and user experience. The main concept of LTE-Unlicensed (LTE-U) is

to use LTE-Advanced features and aggregates carriers in licensed and unlicensed band [1]. LTE-Unlicensed (LTE-U) can be used as a Supplementary Downlink (SDL) data channel (downlink-only) by using Frequency Division Duplex (FDD), or as a Time Division Duplex (TDD) data channel, where downlink and uplink are performed. Figure 1.1 depicts a typical LTE-Unlicensed (LTE-U) deployment [31].

According to recent studies, LTE has significant performance gains over Wi-Fi, when operating in the unlicensed band. In [20], the main advantages for LTE-Unlicensed (LTE-U) over Wi-Fi are better link performance, superior channel access control, exceptional mobility management, and improved coverage. When all these benefits are mixed with the huge amount of available spectrum in 5GHz band, they make LTE-Unlicensed (LTE-U) a promising unlicensed radio access technology.

1.1 Motivations

Driven by ever increasing data demands, LTE-Unlicensed (LTE-U) are becoming a popular area of research. There are numerous research challenges associated with LTE-Unlicensed (LTE-U). Some of these challenges include sharing spectrum regulations, channel selection protocols, less radio frequency interference, and proper coexistence mechanisms [20]. The most active area of research is however decent coexistence mechanisms.

Advantages of LTE-Unlicensed (LTE-U) include its coexistence mechanisms. To

keep interference level down, typically an LTE-Unlicensed (LTE-U) Small Cell (SC) uses proper coexistence mechanisms. A suitable coexistence mechanism leads us to choose the best operating channel while minimizing the interference created to existing Wi-Fi, or other nearby LTE-Unlicensed (LTE-U) networks. Moreover, when all the channels are occupied by Wi-Fi, LTE-Unlicensed Small Cell (LTE-U SC) is forced to use the same channel as Wi-Fi. In this case, Wi-Fi devices do not back off to LTE-U unless the interference level is more than the energy detection threshold. For instance, the energy detection threshold for 20MHz is -62dBm. Therefore, it is a very important research issue to provide proper coexistence mechanisms.

There are different techniques in literature for providing decent coexistence mechanisms for LTE-Unlicensed (LTE-U). They can be divided into different groups. In the first group, which is called channel selection, the least interfering channel is used by LTE-Unlicensed Small Cell (LTE-U SC) [20]. Channel usage is monitored periodically, and a new channel will be reselected if needed. In addition, channels with strong LTE-Unlicensed (LTE-U) links of other operators will be avoided in channel selection.

In the second group, Carrier-Sensing Adaptive Transmission (CSAT) (also called duty cycle) is used as a coexistence mechanism. In the case where a clean channel is not available, based on long-term carrier sensing of co-channel Wi-Fi activities, the Carrier-Sensing Adaptive Transmission (CSAT) algorithm is used to apply adaptive

TDM transmission to LTE-Unlicensed (LTE-U) small cells. Even in very dense deployments, using Carrier-Sensing Adaptive Transmission (CSAT), fair sharing of the channel between LTE-Unlicensed (LTE-U) nodes and Wi-Fi APs can be ensured according to [23, 24].

In the third group, called opportunistic Supplemental DownLink (SDL), opportunistic secondary cells will be in OFF-state in unlicensed spectrum. When a Secondary Cell (SCell) is not needed, such as where there is no UE or no data for users in buffer in the Secondary Cell (SCell) coverage, the Secondary Cell (SCell) goes in the OFF-state.

In another group, called LTE blank subframe allocation, LTE gives up some time resources or goes silent for certain periods (blank subframes) so that coexistence with Wi-Fi is possible. When an LTE-Unlicensed Small Cell (LTE-U SC) coexists with Wi-Fi in the same frequency band, LTE interference severely affects Wi-Fi performance. The reason is that LTE, as opposed to Wi-Fi, does not sense the channel for vacancy prior to transmission. Therefore, Wi-Fi nodes are blocked by LTE-Unlicensed (LTE-U). Wi-Fi nodes are almost silenced when coexisting with LTE-Unlicensed (LTE-U). As proposed in [14, 25], Almost Blank Subframe (ABS) can address this problem.

Finally, Listen-Before-Talk (LBT) is proposed as a high-performance coexistence mechanism. In this thesis, we will focus on the Carrier-Sensing Adaptive

Transmission (CSAT) and the Listen-Before-Talk (LBT) and propose methods of our own to reduce LTE-Unlicensed (LTE-U) interference level, and increase overall throughput performance of both technologies.

1.2 Contributions

Our contributions can be divided in to two main groups. First, we use and adapt two low interference coexistence mechanisms that take advantage of the Carrier-Sensing Adaptive Transmission (CSAT) (duty cycle) and Listen-Before-Talk (LBT) coexistence mechanisms to minimize the interference level of LTE-Unlicensed Supplementary Downlink (LTE-U SDL), while it coexists with other networks, such as Wi-Fi or other types of the LTE-Unlicensed (LTE-U). The effect of LTE-Unlicensed (LTE-U) on the downlink performance of other technologies, like Wi-Fi, or other types of the LTE-Unlicensed (LTE-U) is described. Based on the LTE-Unlicensed (LTE-U) Forum, and 3GPP proposed coexistence mechanisms, different coexistence scenarios are plotted, and the overall throughput performance of both technologies is evaluated for each coexistence scenarios via simulations using Network Simulator NS-3. Having throughput assessments of both technologies for different coexistence scenarios, a comparison will be done. Thus, the more suitable coexistence mechanism, and the most convenient coexistence scenario that decrease LTE-Unlicensed (LTE-U) interference will be depicted. The main focus would be on using LTE-

Unlicensed (LTE-U) as a supplemental downlink data channel.

Using the Listen-Before-Talk (LBT) coexistence mechanism, we then evaluate uplink throughput performance of LTE in the licensed spectrum for different coexistence scenarios, while LTE-Unlicensed (LTE-U) is used as the supplemental downlink data channel . After evaluating different coexistence scenarios, we then introduce the most high-performance scenario which increase the throughput of the network. All the experimental experience will be run by network simulator NS-3.

In general, based on the characteristics of LTE-Unlicensed (LTE-U), we use and adapt a high-performance coexistence mechanism and advanced coexistence scenario in terms of throughput of the network, with the following advantageous features:

1. *Reduced interference.* The proposed coexistence mechanism of 3GPP, called Listen-Before-Talk (LBT) category 4, is based on the Wi-Fi medium access protocol. In other words, it has the same characteristics as Wi-Fi, including exponential backoff. Since LTE does not sense the channel vacancy before transmissions (Carrier Sense Multiple Access with Collision Avoidance (CSMA/CA)), in contrast to Wi-Fi, LTE transmissions tend to block Wi-Fi. The proposed coexistence mechanism by 3GPP, avoids LTE dominant behavior, and forces LTE to imitate carrier sensing feature of Wi-Fi. Therefore, LTE interference can not affect Wi-Fi operations. The proposed coexistence

mechanism in comparison to Load Based Equipment Listen-Before-Talk (LBE LBT) [26], which has static backoff feature, can decrease interference dramatically.

2. *Higher throughput.* Higher throughput can be achieved by the proposed coexistence mechanism, since LTE in unlicensed spectrum is being forced to have best of Wi-Fi behaviors, while it maintains its own LTE features. Therefore, LTE-Unlicensed (LTE-U) obtains best of two technologies, which increase the performance of both networks.
3. *Fair channel access.* Since there are other networks such as Wi-Fi and other LTE-Unlicensed (LTE-U) in the unlicensed spectrum, fair channel access is an issue. The proposed coexistence scenario makes a fair coexistence with other networks a reality, and allows other networks in the unlicensed spectrum to access the channel in an equal manner. Therefore, it will increase overall throughput of all the networks using the unlicensed spectrum.
4. *Wireless unified network.* The proposed coexistence mechanism and scenario, make a wireless unified network, which blends the best capabilities of Wi-Fi and LTE technologies to provide subscribers with more consistent data and voice experience in high-traffic or low-signal locations. The proposed technology allows operators to combine standalone LTE and Wi-Fi networks

into one unified network, particularly for congested areas with low signal strength.

1.3 Thesis Structure

The remainder of the thesis is organized as follows. Chapter 2 provides a literature survey of some of the related projects in the area. The LTE-Unlicensed (LTE-U) bands in 5GHz, non-Listen-Before-Talk (non-LBT) coexistence mechanisms, and throughput performance of different simulation coexistence scenarios are described in Chapter 3. In Chapter 4, we adapt the use of the Listen-Before-Talk (LBT) coexistence mechanism for LTE-Unlicensed Small Cell (LTE-U SC). Then, a comparison between Wi-Fi Listen-Before-Talk (Wi-Fi LBT) and Load Based Equipment Listen-Before-Talk (LBE LBT) is plotted. Our simulation results are presented to show the advantages of Load Based Equipment Listen-Before-Talk (LBE LBT) method. Uplink performance evaluation of LTE-Unlicensed Small Cell (LTE-U SC) is presented in Chapter 5. We also provide experimental results to demonstrate the correctness of our coexistence mechanism and scenario. Chapter 6 concludes the thesis and outlines some directions for future work.

2 Literature Survey

In this chapter, a literature survey is presented of some of the background and related projects. As discussed in the previous chapter, there are two main carrier aggregation schemes with unlicensed bands, namely LTE-U/LAA (LTE-Unlicensed/Licensed Assisted Access) and LWA (LTE and Wi-Fi link Aggregation). In this thesis, we use novel coexistence schemes, and different coexistence scenarios, to compare these two technologies to achieve high performance for unlicensed LTE. To the best of our knowledge, there has not been a study comparing these two technologies to achieve the best user experience. As the result, we first take a look at some related approaches on LTE unlicensed, and Wi-Fi, then we survey some of the fundamental concepts on LAA/LTE-U (Licensed Assisted Access/LTE-Unlicensed), followed by some other concepts on LWA (LTE and Wi-Fi link Aggregation).

2.1 Unlicensed LTE

Presently, Wi-Fi, the preferred term for IEEE 802.11 wireless local area networks (WLANs), has become a vital wireless technology for broadband Internet access in our daily lives, beyond the original intention of its introduction to replace Ethernet cable. Using WiFi, network operators can increase the capacity and coverage of their wireless deployments to meet the increasing demand of customers need, according to [1–9]. According to the statistics in the United States, Canada, Japan, South Korea, Germany, and the United Kingdom, Wi-Fi contributed to about 73 percent of wireless traffic on Android smartphones in April 2013 [10].

In June 1997, the IEEE 802.11 Working Group (WG) introduced the first IEEE 802.11 standard, accompany with MAC and PHY layers, and has since released IEEE 802.11a (Sep 1999) at 5 GHz, b (Sep 1999) at 2.4 GHz, g (June 2003) at 2.4 GHz, and n (Oct 2009) at 5 GHz versions. Starting with data rates up to 2 Mb/s defined by IEEE 802.11 standard, then 54 Mb/s defined by OFDM in IEEE 802.11a, it reached up to 600 Mb/s in IEEE 802.11n, which is comparable to the speed of an Ethernet wired network [10]. The key drivers of such improvements were the adoption of MIMO, channel bonding, and frame aggregation, through which the spatial and spectral efficiencies, and resource utilizations were increased. The IEEE 802.11n has resulted in revolutionary technology of Wi-Fi. Therefore,

the IEEE 802.11 WG and Wi-Fi Alliance (WFA) continue to develop a number of advanced technologies, in which throughput enhancement, long-range extension, and greater ease of use were three major factors in Wi-Fi technological evolution [10] as shown in Figure 2.1.

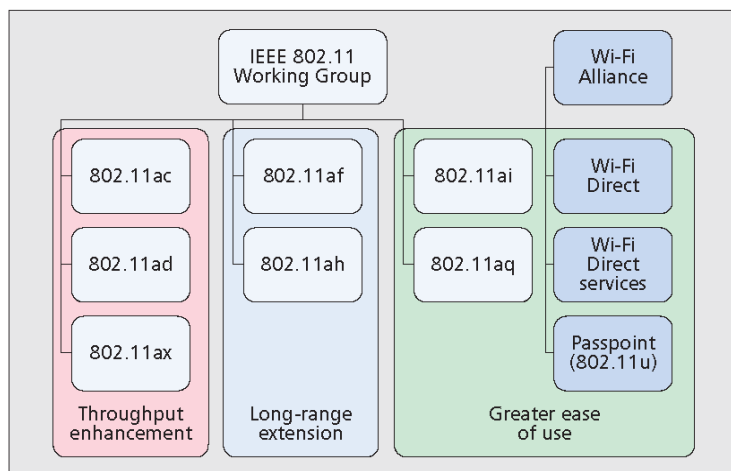

Figure 2.1: Wi-Fi technological evolution [10].

High-throughput WLAN and faster Wi-Fi has been achieved by the adoption of two recently approved IEEE 802.11 amendments, IEEE 802.11ac, and IEEE 802.11ad. The goal is to provide theoretical maximum throughputs greater than 1 Gb/s. IEEE 802.11ac, which is the 5 GHz successor to 802.11n, improves the maximum throughput by: multi-user MIMO (MU-MIMO), larger channel bandwidths of 80 and 160 MHz, and 256-QAM. IEEE 802.11ad, also known as Wireless Gigabit (WiGig), operates over the unlicensed 60 GHz frequency band, the millimetre-wave (mmWave) band, which suffers from severe propagation loss and signal attenua-

tion, resulting in a short communication range [10]. IEEE 802.11ad is used for high-definition (HD) video transmission, and high-rate data synchronization. The IEEE 802.11ax, which is the successor to IEEE 802.11ac, aims to improve the efficiency of spectrum utilization by enhancing the area throughput, and average per user throughput in both indoor and outdoor highly-dense deployment scenarios by improving both PHY and MAC layers.

According to [10], long-range extensions at frequency bands below 1 GHz is the main purpose of IEEE 802.11af, and IEEE 802.11ah. IEEE 802.11af outlines WLAN operations in TV White Spaces (TVWS) to supply so-called Super Wi-Fi. A Super Wi-Fi signal can travel longer distances than a typical Wi-Fi signal. In general, over-the-air broadband access can be implemented at lower cost by deploying 802.11af APs less densely. IEEE 802.11ah is known for large-scale low-rate sensor networks such as small grid, where the number of involved devices in a network could be larger than that of traditional 802.11 Wi-Fi. Therefore, the power saving features become critical to the throughput of 802.11ah, since devices in the sensor networks are likely to be battery-powered [10].

IEEE 802.11ai is popular for fast initial link setup, which is a technical term that clarify the procedures needed for a first time user to establish a secure Wi-Fi link with the most approving AP. IEEE 802.11aq is known for pre-association discovery, where it helps the Wi-Fi users to select the right AP by making more

information available to them before association.

Presently, LTE, which is one of the most important cellular deployments worldwide, is operating in the licensed spectrum (from 700 MHz to 2.6 GHz). LTE has more controlled behavior than Wi-Fi, which operates in the unlicensed spectrum, by means of the exclusive spectrum occupancy. Recently, as we encounter the increase demand for mobile traffic, additional spectral resources are needed. Thus, LTE in unlicensed bands especially the 5 GHz unlicensed band has attracted researchers attention [10].

According to [11], future high-data-rate Wi-Fi is possible by utilizing wide bandwidth at high frequencies. Power efficiency improvement is becoming increasingly harder to obtain as we continue increasing data rates for future Wi-Fi systems. In [12], a low-power architecture design is suggested for large bandwidth Wi-Fi systems which can adapt to the data rate requirements of the application and scale with bandwidth.

Merging the cellular network with Wi-Fi has been considered as an acceptable way to carry the increasing mobile traffic, according to [13]. Wi-Fi management architecture and resource management play an important role in Wi-Fi network with increasing Wi-Fi traffic and density. Expansion of the Wi-Fi architecture has the potential to obtain further achievement with the following three approaches [13].

The first approach is contemplation of more wireless systems, composed of con-

vergence with other wireless access in different frequency bands and coexistence with other wireless systems operated by different operators [13].

The second approach is distribution with backhaul networks. Traffic monitoring can identify the backhaul network bottleneck. Resources can also be distributed into different access networks and nodes. The backhaul access networks can be a bottleneck, since the aggregated throughput in the dense mobile UEs increases. To solve the backhaul networks bottleneck, the optimization of all traffic, composed of wired and wireless accesses, will be needed [13].

The third approach is cross-layer optimization considering the suitable application layer structure for the network architecture. This approach plays an important role in future wireless access systems [13].

All the approaches requires large-scale optimization, and some information which is not directly relevant to mobile traffic such as people's behavior at public events or in weather, can influence the performance estimation at the management server by enabling better offloading. Wi-Fi platform architecture for future wireless access systems will optimize traffic sharing between Wi-Fi and cellular networks, and will increase mobile network performance [13].

2.2 Wi-Fi MAC Model

In this section, a brief overview of the Wi-Fi components is described.

Distributed Coordination Function (DCF) is used by Multiple Access Control (MAC) layer to share the channel between multiple stations. DCF uses Carrier Sense Multiple Access/Collision Avoidance (CSMA/CA) to share the channel between stations. Distributed Inter-Frame Spacing Time (DIFS) is a time that every AP/STA should wait before accessing the medium to transmit data [20]. If the channel is available after DIFS, the Wi-Fi node (AP/STA) chooses a random backoff from $[0, CW]$, and for every idle slot the node decrements the counter. The Wi-Fi node (AP/STA) can transmit when the counter reaches to zero. In case when the channel is busy during the countdown, the backoff counter is frozen until the channel is sensed to be free for at least DIFS, then the counter is counted down from its previous value [20]. Figure 2.2 illustrates DCF channel access.

According to [20], Wi-Fi slots are $9\mu s$. In DCF the exponential backoff process is also called binary exponential backoff. At first the contention window takes value CW_{min} , and it increases each time that transmission fails, and no ACK is received. After a failed transmission, the backoff will have a CW value from $2 * (CW + 1) - 1$ to CW_{max} . After a successful transmission, the backoff value will reset to CW_{min} . Figure 2.3 shows the successful data transmission. Short Inter-Frame Spacing Time (SIFS) is a time that every Wi-Fi node (AP/STA) should spend to process a received frame and to respond with ACK.

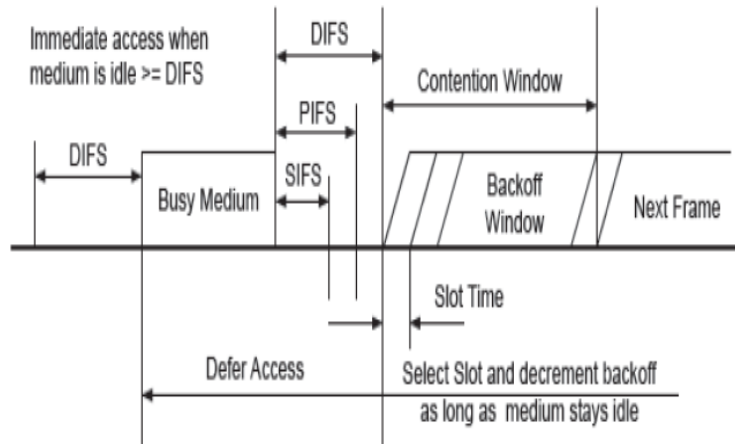

Figure 2.2: IEEE 802.11 DCF channel access [20].

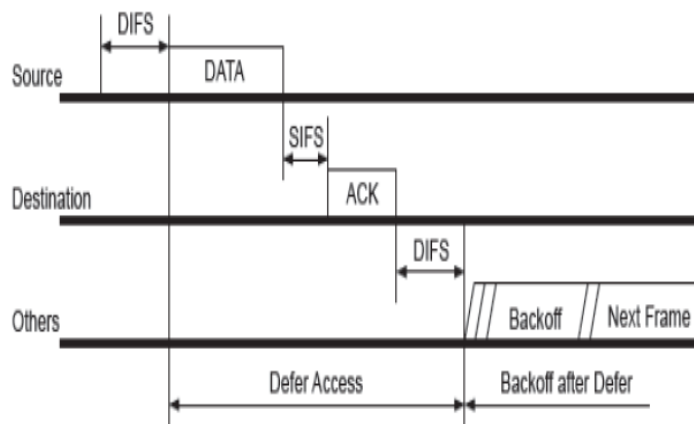

Figure 2.3: Successful data transmission by IEEE 802.11 [20].

2.3 LTE and Wi-Fi Coexistence in Unlicensed Band

The coexistence of LTE and Wi-Fi in unlicensed bands from the radio resource management perspective has been considered in [14], although these two prominent technologies were designed to work in different bands and not to coexist in a shared band. It was determined that LTE and WI-Fi, are not only dissimilar but also incompatible when operating in the same band since they adopt asynchronous time slots, different channel access mechanisms, and disparate transmission and interface ranges.

Wi-Fi uses OFDM for encoding digital data on multiple frequencies. In Wi-Fi infrastructure, an access point (AP) bridges a basic subscriber set (BSS) of wireless stations (STAs) to a wired Ethernet network. STAs and APs use a Wi-Fi default channel access mechanism, the distributed coordination function (DCF), to manage the frames and exchange data. As we mentioned in the previous section, DCF uses a contention-based protocol known as carrier sense multiple access with collision avoidance (CSMA/CA), in which nodes listen to channel prior to transmit by means of clear channel assessment (CCA). A node in CCA may get transmissions from other nodes, causing the channel to be seen as occupied, and therefore deferring transmission to a random backoff time. Backoff and CCA decrease the chance of transmission collisions in Wi-Fi at the cost of lower channel utilization. It is

worth mentioning that Wi-Fi is a network with distributed MAC, where packets are transmitted based on the mechanism of each station. Therefore, the traffic pattern is not predictable [14].

LTE employs multi-user version of OFDM (OFDMA). In LTE multiple access is achieved by assigning subsets of subcarriers to individual user equipments (UEs) for a specific number of symbol times (i.e., physical resource block, PRB), thus allowing simultaneous transmissions from several UEs. LTE has much more flexibility regarding resource allocation in time and frequency domains, in comparison with Wi-Fi. In addition, LTE does not require carrier sensing prior to transmission. Instead, the LTE base station (eNodeB) allocates radio communication subchannels for channel estimation and equalization, synchronization, management, and data transmissions. Deployment of eNodeB is usually planned, and inter-eNodeB communication infrastructure may be used for spectrum coordination. It is worth noting that LTE is a network with centralized MAC, where a central controller allocates the time and frequency resource for each station. Thus, the maximum channel efficiency can be obtained since the central controller has the control on every packet [14].

The LTE deployment model for unlicensed spectrum bands is challenging. The first challenge is that regulatory agencies restrict the effective isotropic radiated power (EIRP) in unlicensed spectrum bands to much lower levels than usually used

in LTE macrocells. The second challenge is that LTE should be able to determine if Wi-Fi is jointly operating in the same spectrum and also establishing a coexistence mechanism with it. Therefore, LTE small cells seems to be a natural deployment model for LTE operation in unlicensed spectrum. According to [14], when nodes of the two technologies coexist in the same frequency band, LTE interference significantly affects Wi-Fi operation. This is because LTE, in contrast to Wi-Fi, does not sense for channel vacancy prior to transmission; therefore, Wi-Fi nodes have a tendency to be blocked by LTE transmissions, making the Wi-Fi nodes to stay on the listen mode more than 96% of the time, which decrease Wi-Fi throughput from 70% to 10% [15]. According to [15], LTE outperforms Wi-Fi in similar scenarios. Wi-Fi performance is further degraded when it operates concurrently with LTE while LTE performance is nearly unchanged. This is because of the LTE interference at the Wi-Fi side and due to the fundamental limitation of Wi-Fi protocol, such as, carrier sensing that blocks the Wi-Fi channel and makes the Wi-Fi nodes to stay on the listen mode for 96% of the time. In general, Wi-Fi is almost silenced when coexisting with LTE, because LTE is rarely affected by Wi-Fi interference. This can be easily seen on the average user throughput performance of both LTE and Wi-Fi demonstrated in Figure 2.4, especially for the high node density case [14]. Figure 2.4 compares the LTE and Wi-Fi average user throughput, relative to Wi-Fi low AP density and high AP density for an indoor scenario. Low AP density is

composed of 4 APs per technology and high AP density is composed of 10 APs per technology with an average STA density of 2.5 per AP for low and high AP density. LTE and Wi-Fi evaluation is isolated (LTE, Wi-Fi) and in coexistence (LTE(Coex) and Wi-Fi (Coex)), according to [14].

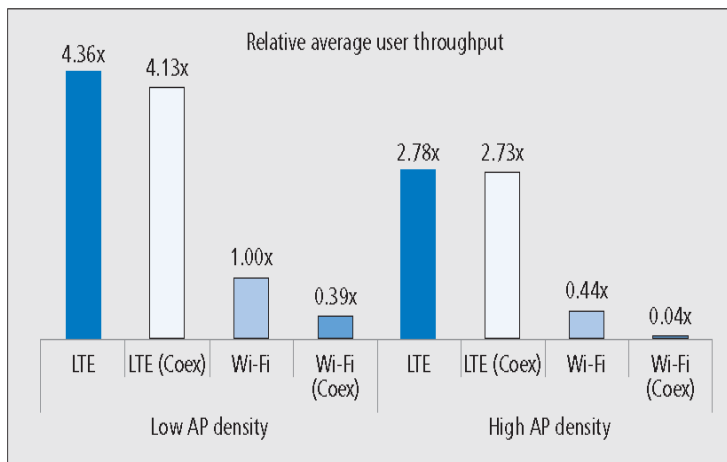

Figure 2.4: LTE and Wi-Fi average user throughput [14].

To overcome the main differences in channel selection and network deployment between Wi-Fi and LTE technologies, some Wi-Fi access points (APs) implement simple channel selection techniques, such as least congested channel search (LCCS), in which the AP monitors its own channel, while also searching for incoming packets from other APs, and selects the least congested one. Therefore, since Wi-Fi can be blocked by LTE when coexisting, it would be the best choice for Wi-Fi to select the least congested channel for operation. In this case, some coordination between the Wi-Fi APs and LTE eNodeB for channel selection could pave the way of

channel selection. This is essential, since a common intertechnology communication framework for LTE and Wi-Fi should be available [14].

Generally, since Wi-Fi is a distributed MAC network, and LTE is a centralized MAC network, there is a need for a coexistence algorithm, otherwise the throughput of Wi-Fi will be significantly reduced. The reason is that the central controller in LTE tries to maximize the channel efficiency, so it always transmits, and Wi-Fi nodes need to wait for LTE to stop its transmissions. In addition, LTE and Wi-Fi packets may collide together, therefore a fair coexistence algorithm is needed to get channel efficiency and fair resource allocation for LTE and Wi-Fi.

2.4 Wireless Unified Network

New wireless unified networks capabilities combine cellular and Wi-Fi to double download speeds, notably increase upload speeds and extend network range according to [15]. A wireless unified network blends the upload and download capabilities of Wi-Fi and cellular technologies to provide subscribers with higher capacity, and higher-quality mobile voice, data, and video experience in low signal or high traffic locations. A wireless unified network allows operators to mix standalone cellular and Wi-Fi networks into one unified wireless network for indoor/outdoor environments.

Presently, subscribers are switched between cellular and Wi-Fi to load-balance

the network, or users may manually switch between networks to seek optimum performance. Alcatel-Lucent has introduced three different methods to blend Wi-Fi and cellular access in order to unify the user experience across Wi-Fi and cellular [15]. Three methods are as follows:

- coexistence (cellular boost(LTE-U/LAA))
- combination (Wi-Fi boost, and Wi-Fi boost with aggregation)
- aggregation (Wi-Fi boost with aggregation and LTE-U/LAA)

All of these three methods achieve the same goal, which is to give a boost to LTE data throughput by augmenting it with unlicensed spectrum. These three methods will be explained in the following sections.

2.4.1 LTE-Unlicensed/Licensed Assisted Access

LTE-Unlicensed/Licensed Assisted Access (LTE-U/LAA), which is known as cellular boost, utilizes LTE in unlicensed spectrum to enhance capacity while coexisting with existing Wi-Fi. Cellular boost includes LTE unlicensed (LTE-U) and License Assisted Access (LAA) capable small cells. LTE-U which is mostly interested by cell providers in United States like Verizon Wireless, is just more spectrum for LTE. It uses unused unlicensed spectrum. LTE-U relies on Qualcomm's carrier sensing adaptive technology and duty cycle for coexistence.

According to [15], in LTE-U, based on long-term carrier sensing of co-channel Wi-Fi activities, Carrier-Sense Adaptive Transmission (CSAT) algorithm is utilized to apply adaptive TDM transmission to LTE-U small cells. This forms a duty cycle, that is, when LTE-U is in ON-state, Wi-Fi is in OFF-state, and vice versa. Therefore, using CSAT, even in very dense deployments, fairly sharing the channel between LTE-U nodes and Wi-Fi APs can be ensured. It is worth mentioning that Wi-Fi is “polite”, in other words, Wi-Fi will use the spectrum, if other technologies are not using the spectrum. Thus, this method guarantees fairness between the two technologies.

As previously mentioned, using CSAT, the LTE-U small cell detects what kind of activities are on the channels. If they can find an open unused unlicensed channel, it uses coexistence. If it can not find an open unused unlicensed channel, CSAT tries to find the least loaded channel and then make determination about what activity or what percentage of time is being utilized. CSAT makes a determination about what percentage of time should allocate to LTE and what percentage to Wi-Fi [15].

According to [15–17], Licensed Assisted Access (LAA), is mostly interested by cell providers in Europe like Ericsson. LAA is the 3rd Generation Partnership Project’s (3GPP) effort to standardize operation of LTE in the Wi-Fi bands. It uses a contention protocol known as listen-before-talk (LBT), mandated in some European countries, to coexist with other Wi-Fi devices on the same band accord-

ing to Wikipedia. LAA, which utilizes the 3GPP standardized Listen-Before-Talk (LBT) algorithm, ensures fair sharing while preventing Wi-Fi interruption. Wi-Fi also uses Listen-Before-Talk (LBT) algorithm, so it waits when others are using the spectrum, this is because Wi-Fi is polite. Therefore, researchers are optimistic about LAA and Wi-Fi coexistence, since they are both based on protocols [15–17].

According to [18], the main principle of LAA is that LTE-Advanced services (such as carrier aggregation) are anchored in licensed spectrum, with unlicensed frequencies used opportunistically to boost capacity and throughput. A primary cell uses licensed spectrum to provide a robust connection for control signalling, mobility and user data. A secondary cell uses unlicensed spectrum to carry best effort user data, to provide a speed boost. Figure 2.5 [18] illustrates the principle of LAA.

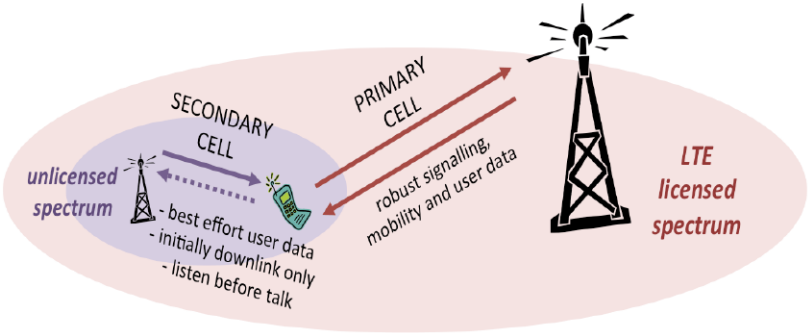

Figure 2.5: LTE Licensed Assisted Access principle [18].

LTE-U and LAA aggregate LTE carriers in unlicensed bands with existing LTE bands. They use unlicensed spectrum for opportunistic data boost. Generally, they operate in indoor small cell deployments. CSAT channel type access of LTE-U (non-LBT) is not 3GPP standard. LAA using LBT channel access follows the 3GPP standard. LAA with LBT, which is proposed in the Rel 13 standard, will operate as downlink-only. In Rel 14, uplink will be proposed as well. It is worth mentioning that LTE-U/LAA is better neighbour to Wi-Fi than Wi-Fi itself, as this thesis will show by simulations and experiments.

The impact of cellular boost (LTE-U/LAA) on users are: greater speed, improved edge performance, and high-throughput network coexistence with Wi-Fi. Cellular boost (LTE-U/LAA) has also some benefits for operators such as: access to 20 MHz wide channels, improved range or better coverage, and augment licensed spectrum with 120+ MHz of unlicensed frequency.

2.4.2 LTE and Wi-Fi Link Aggregation

The second method is Wi-Fi boost, in which users have simultaneous access to both Wi-Fi and cellular (3G/4G). Wi-Fi boost combines the best of Wi-Fi and the best of cellular: the best of Wi-Fi means that downlink traffic is delivered via Wi-Fi alone, and the best of cellular means that uplink traffic (including Wi-Fi TCP ACKS) is carried via cellular.

In Wi-Fi boost with aggregation which is also called as LTE and Wi-Fi Link Aggregation (LWA) by 3GPP, uplink traffic carries via cellular, and downlink is aggregation on Wi-Fi and LTE. Carrier aggregation is the most important technology driven by LTE-Advance.

After LTE-U and LAA, LTE and Wi-Fi Link Aggregation (LWA) is the third option for LTE over unlicensed bands, that allow carriers to utilize existing Wi-Fi nodes (with software update on handsets), run Wi-Fi in unlicensed spectrum and LTE in a licensed band and aggregate the two. This approach is expected to be part of the finalized Rel 13. Ruckus Wireless, which has called LWA “potentially the best of both worlds” [18].

Wi-Fi boost and Wi-Fi boost with aggregation (LWA) can benefit users through: a 70% increase in Wi-Fi downlink in case of multi user, a 20%-30% increase in Wi-Fi downlink in case of single user, a 10x or more increase in uplink, an increase in Wi-Fi range by 2x, and high consistent Wi-Fi performance. Wi-Fi boost and Wi-Fi boost with aggregation (LWA) can benefit the operator by: adding value beyond basic coverage, increasing speed to market, utilizing existing UEs, being applicable to 3G and 4G, and compatible with existing Wi-Fi APs.

According to [18], LWA aggregates Wi-Fi carriers in unlicensed bands with existing LTE bands. LWA aggregates LTE and Wi-Fi carriers. It is based on 3GPP Rel 13. It requires architectural modifications. It can also integrate legacy WLAN de-

ploysments. LWA utilizes unlicensed spectrum by aggregating at the PDCP (Packet Data Convergence Protocol) layer LTE on licensed band and Wi-Fi on unlicensed band, as demonstrated in MWC 2015 in Figure 2.6 [18].

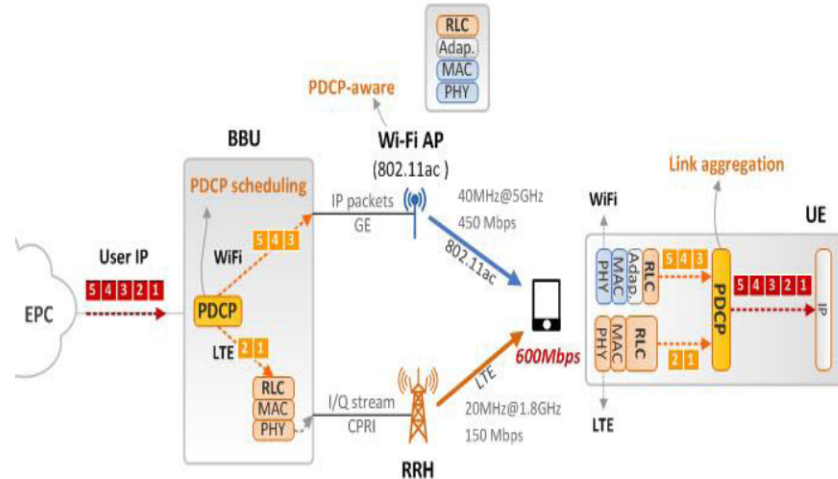

Figure 2.6: LWA architecture [18].

LTE-U/LAA/LWA support Supplementary Downlink (SDL) only at this stage. The uplink will be done in 3GPP Rel 14. They all utilize the 5GHz license-exempt band. LTE-U/LAA/LWA is illustrated in Figure 2.7 [18]. In addition, LTE-U/LAA/LWA have the following benefits [18]: coverage and capacity guarantee, mobility and service continuity, QoS guarantee, and higher data rates.

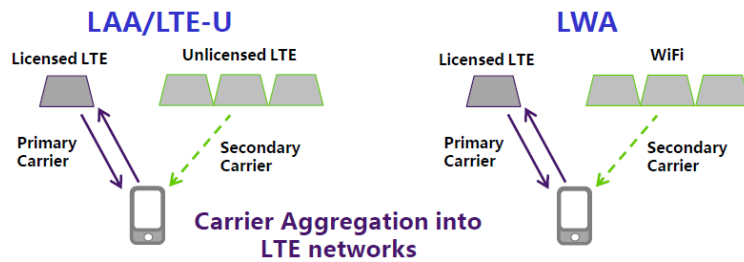

Figure 2.7: LTE-U, LAA, and LWA technologies [18].

2.4.3 LTE and Wi-Fi Link Aggregation and LTE-Unlicensed/Licensed Assisted Access

In the third method, Wi-Fi boost with aggregation and LTE-U/LAA can be done in parallel and then combined to deliver wireline speeds, wirelessly. In this scheme, uplink traffic is carried via LTE, and downlink traffic is delivered over the aggregation of Wi-Fi, licensed LTE, and LTE in the unlicensed spectrum. The results of this method on users are: greater speed, improved quality of experience, and true wireless experience. This method has also some benefits for operator by: providing flawless video services, greater relevancy to users in the home and enterprise, increasing the ability to offer flawless video and new services [18].

2.5 Thesis Overview

In this chapter, we surveyed some of the background and related projects of this thesis. In this section, we will give an overview of the thesis with respect to the

materials presented in the previous sections. As it was mentioned previously, LTE-U/LAA uses licensed spectrum as an anchor to provide a robust connection for control signalling, and it uses unlicensed spectrum to provide a speed boost. LTE-U/LAA aggregate LTE carriers in unlicensed bands with existing licensed LTE bands. On the other hand, LWA aggregates Wi-Fi carriers in unlicensed bands with existing licensed LTE bands. Therefore, it is obvious that unlicensed LTE bands have some effects on the downlink and uplink performance of other networks, such as Wi-Fi, or other unlicensed LTE bands. It is worth mentioning that, in this thesis, NS-3 is used for our simulations, and since it is based on FDD at this stage, unlicensed spectrum is used as supplemental downlink, where we only aggregate downlink in unlicensed spectrum to boost the downlink-only transactions.

Given the beneficial effect of, LTE-U/LAA and LWA, it is natural to study the performance of LTE-U/LAA, and LWA, and also the effects of one on the other networks. In addition, we study the overall effects of any combination of these technologies on other networks, like Wi-Fi, or other LTE-U/LAA, in order to make high-performance LTE-U/LAA. Different coexistence mechanisms are studied, but two coexistence mechanisms ensure fair channel access. However, as it was shown in the survey section there is no project in the literature that studies these effects. Therefore, in this thesis we compare LTE-U/LAA and LWA, their downlink system performance using two different coexistence mechanisms, and study the effects of

any combination scenarios on other networks, like Wi-Fi. We conclude that LAA is a better neighbour to Wi-Fi than Wi-Fi itself. Finally, we provide different simulation scenarios using NS-3, which precisely prove our results. In addition, in the second part of the thesis, uplink performance evaluation of LAA in licensed spectrum is presented by experimental results.

The rest of this thesis is organized as follows. In Chapter 3, we present the system model, architecture, and different experimental scenarios results for LTE-U using the CSAT coexistence mechanism. In Chapter 4, we cover LAA LBT coexistence mechanism fundamentals and study the effects of LAA on the other networks like Wi-Fi or other LAA networks. Downlink system performance is analyzed for multi-operator LAA deployment. We also run different simulation scenarios to obtain performance evaluation of LAA, and any combination scenarios with other networks, like Wi-Fi, or other LAAs. We conclude chapter 4 by introducing the high-performance LAA scenario with a fairness mechanism for LAA coexistence. An uplink performance evaluation of LAA, and experimental results are presented in Chapter 5. Finally, we conclude the thesis with Chapter 6.

3 LTE-Unlicensed Supplementary Downlink (SDL) Coexistence with non-LBT

In this chapter we will present our system model, which is composed of a LTE-U Small Cell (SC) coexisting with the Wi-Fi ecosystem in the 5GHz unlicensed band. In general, our system models are inspired by the model used in [20]. Currently, a number of access technologies such as 802.11 (Wi-Fi), 802.15.1 (Bluetooth) and 802.15.4 (ZigBee) are deployed in 2.4GHz ISM and 5GHz U-NII bands. These bands are known as “Unlicensed” or “Licensed-Exempt” bands. Until now, access technologies such as Wi-Fi has played an important role in unlicensed spectrum for radio access, especially for data offloading. Conventionally, the unlicensed spectrum has been inconvenient for use in licensed bands, such as LTE, that concentrate on expanding spectral efficiency and improving user experience. Carrier Aggregation (CA) which is one of the LTE features, has made it possible to operate LTE in unlicensed bands as well. Recently, new studies have found that LTE technology, primarily featured for cellular operation in licensed bands, has dramatic

achievement over Wi-Fi when operating in the unlicensed band. The advantages of LTE-U over Wi-Fi include: significantly improved coverage, higher spectral efficiency, better performance, mobility management, and superior medium access control. In addition, the user benefits from higher data rates, enhanced broadband experience, seamless support for handover and service continuity as UE leaves the unlicensed-band service area, with high reliability and robust mobility through licensed carrier. These advantages combined with the huge amount of spectrum (more than 400MHz) in the 5GHz spectrum which make LTE-U a perfect radio access technology in the unlicensed band.

According to the LTE-U Forum [20], to avoid haphazard and unplanned deployment of LTE-U Small Cell (SC) interfering with Wi-Fi, proper coexistence design of LTE in the unlicensed band is extremely vital. “Friendly” design of LTE in the unlicensed band to coexist with current access technologies such as Wi-Fi, when using the same channel, or so-called “fairness” (fairly sharing the same channel), plays an important role in the LTE-U success. However, operation in the unlicensed band also needs to factor in the regulatory requirements of a given region. According to Signals Research Group [21], in some countries, like Europe and Japan, a special waveform requirement is required to support LBT (Listen-Before-Talk) at a millisecond scale, which needs some changes in LTE air interface. In other countries, like US, China, India and Korea, no such waveform requirements are needed.



Figure 3.1: 5GHz unlicensed spectrum band plan [21].

In these countries, mobile operators can deploy LTE-U to coexist with Wi-Fi using LTE Release 10/11 without any changes in LTE air interface and without any need to LBT at millisecond scale. In other countries where LBT is needed, LTE-U can be optimized through air interface enhancement with LBT feature suggested in 3GPP Release 13. Figure 3.1 illustrates 5GHz unlicensed spectrum band plan in different countries [21].

LTE-U is built on top of LTE-Advanced carrier aggregation, which is rolled out commercially since 2013. Figure 3.2 illustrates LTE-U operation modes in unlicensed band [22]. Supplemental downlink (SDL) is shown on the left side of the Figure 3.2 where the unlicensed band is used with downlink-only carrier aggregation, which would be the simplest form of LTE-U, while the uplink would be in line

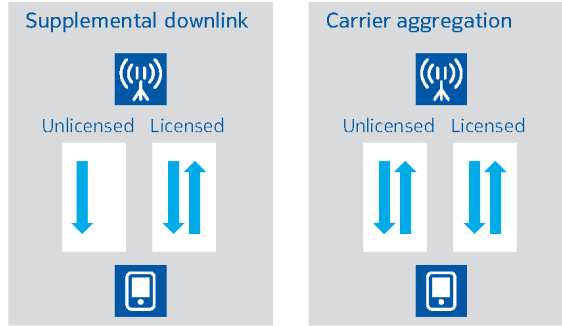

Figure 3.2: 3GPP LTE-U operation modes [22].

with 3GPP carrier aggregation principles as demonstrated on the right side of the Figure 3.2 according to [22]. In SDL, unlicensed band is used with downlink-only carrier aggregation, while in the next step, 3GPP will use unlicensed band with downlink and uplink carrier aggregations.

Our system model is based on supplemental downlink (SDL) deployment in unlicensed band, shown on the left side of the Figure 3.2, which will be paired with a licensed LTE carrier as carrier aggregation mode in legacy LTE. This deployment targets the regions, like US, without LBT requirements. With this system model in mind, the rest of this chapter is organized as follows. In Section 3.1 band definitions for LTE-U in 5GHz will be discussed, to have better understanding about the bands for LTE-U in 5GHz. Section 3.2 covers different coexistence mechanisms without LBT requirements. Finally, in Section 3.3 experimental simulation results are provided.

3.1 Channel Numbers for LTE-Unlicensed Bands

In this section, to have a clear idea about the licensed and unlicensed bands, we will describe the licensed and unlicensed bands differences. As we know, licensed band provides us with a unique frequency that we can use it legally. Licensed bands are more powerful and it has a coverage of up to 2.5 miles. Higher coverage is possible by using repeaters. Licensed bands are slightly more expensive compare to non-licensed spectrum, since they usually have more applications. In contrast, license-free bands work over a smaller area with coverage of about 1 mile. Since other users can transmit on the same frequency of unlicensed bands, there may be interference. In total, licensed bands are more expensive than license-free bands.

According to LTE-U Forum [20], there are three Unlicensed National Information Infrastructure (U-NII) bands in US 5GHz unlicensed spectrum. These three bands are U-NII-1 (5150-5250MHz), U-NII-2 (5250-5725MHz), and U-NII-3 (5725-5850MHz). For SDL, only FDD carrier aggregation is required for the carrier aggregation with a LTE FDD licensed carrier. Band numbering for U-NII bands is as follow:

1. U-NII-1 : Band number 252 for U-NII-1 spectrum (5150-5250MHz).
2. U-NII-2 : Band number 253 and 254 are reserved for U-NII-2 spectrum (5250-5725MHz) for future usage.

3. U-NII-3 : Band number 255 for U-NII-3 spectrum (5725-5850MHz).

The 100KHz channel raster, currently used in LTE, causes some problems for wide bands such as 5GHz unlicensed band, since the search space is too large for eNB or UE, according to [20]. In order to solve this problem, we have to have a reduced set of carrier frequencies. As a result, LTE-U operation will be limited to U-NII-1 with 5160, 5180, 5200, 5220, 5240MHz carrier frequencies and U-NII-3 with 5745, 5765, 5785, 5805, 5825MHz carrier frequencies.

3.2 Coexistence Mechanisms without Listen-Before-Talk (LBT)

As mentioned previously, in the US, China and South Korea, there is no regulatory requirement in the unlicensed band. In these countries, operators can deploy LTE-U compatible with Rel. 10/11 3GPP LTE standards with correctly designed coexistence mechanisms realized by software. Therefore, small cells and UEs can aggregate unlicensed carrier as a SDL with a primary carrier in licensed bands. 5GHz support and carefully design coexistence mechanisms are required to assure harmonious coexistence with Wi-Fi.

Without changing Rel. 10/11 LTE PHY/MAC standards, three coexistence mechanisms which reassure that LTE is a good coexistence technology to Wi-Fi, or a “good neighbour” to Wi-Fi in unlicensed spectrum [23] as well as high-performance

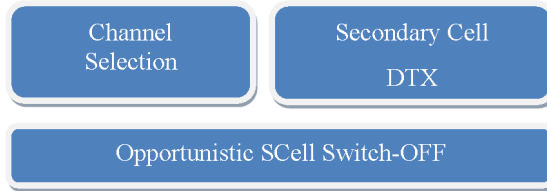

Figure 3.3: LTE-U coexistence mechanisms without LBT requirements [20].

system in many scenarios than Wi-Fi, will be described in this section. Figure 3.3 illustrates three coexistence mechanisms. In the beginning, channel selection enables small cells to choose the cleanest channel based on Wi-Fi and LTE measurements. This will assure the interference is avoided between the small cell and its neighbouring Wi-Fi devices and other LTE-U small cells, provided an unused channel is available. The channel selection algorithm monitors the status of the operating channel on an on-going basis, and if needed will change and select a more suitable one. In the case where no clean channel is available, the SCell DTX algorithm is used to apply adaptive or static TDM transmission to LTE-U small cells, based on 10s-100s of msec carrier sensing of co-channel Wi-Fi activities. This assures that LTE-U nodes can share the channel fairly with the neighbouring Wi-Fi APs, even in very dense deployments. Furthermore, opportunistic SCell switch off can decrease interference to Wi-Fi due to CRS when SCells are not needed. This decision can be made based on traffic demand of unlicensed band associated users compared to what PCell can provide. This is possible since the primary carrier

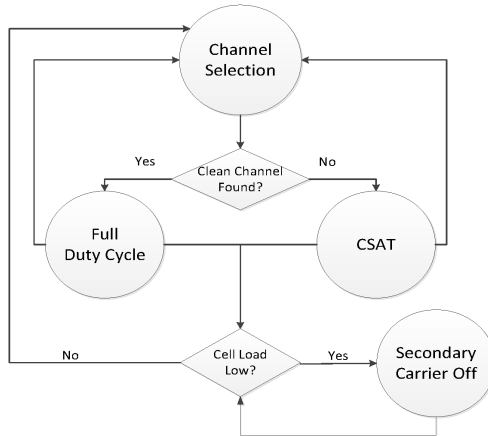

Figure 3.4: LTE-U coexistence algorithms flow chart without LBT [23].

is always operating in the licensed band for RRC (Radio Resource Control) connection. As a reminder, RRC connection is available when an UE requests a call establishment and get resources from UTRAN. Figure 3.4 shows coexistence mechanisms flow chart. To provide more information, Section 3.2.1 covers the channel selection mechanism. Section 3.2.2 provides carrier sensing adaptive transmission mechanism. Opportunistic SDL is covered in Section 3.2.3. LTE blank subframe allocation is presented in Section 3.2.4.

3.2.1 Channel Selection

“Channel Selection” facilitates small cells to select the clearest channel based on Wi-Fi and LTE analysis. Provided that there is an unused channel, the interference is

avoided between the small cell and its neighbouring Wi-Fi devices and other LTE-U small cells. The status of the operating channel is monitored on an on-going basis by Channel Selection algorithm, and in some cases, it will change to a more convenient channel.

In the case where clean channel is not available, based on long-term carrier sensing of co-channel Wi-Fi activities, Carrier-Sensing Adaptive Transmission (CSAT) algorithm is used to apply adaptive TDM transmission to LTE-U small cells. Even in very dense deployments, with using CSAT, fairly sharing the channel between LTE-U nodes and Wi-Fi APs can be ensured.

Additionally, based on the traffic demand, the SDL (Supplemental Downlink) can be operated opportunistically. In case of the small cell's lightly loaded situations, the secondary component carrier in the unlicensed band can be turned off to avoid transmission of overheads such as CRS signals, which further decreases the interference to neighbouring Wi-Fi APs. This feature is possible, since the primary carrier is always operating in the licensed band for RRC (Radio Resource Control) connection as shown in Figure 3.5 [23].

In the channel selection mechanism, LTE-U small cells scan the unlicensed band to find unused or cleanest channels for the SDL carrier transmission. The assessments are executed at both the initial power-up stage and later at SDL operation stage regularly. The SDL transmission will be changed to the new channel using

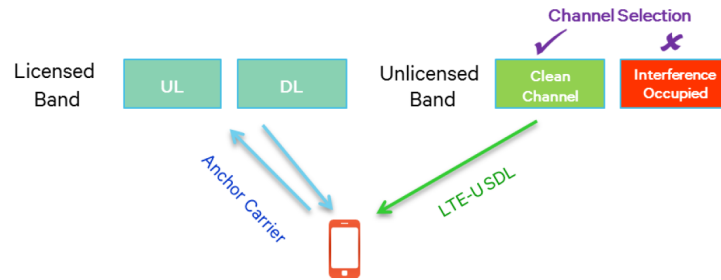

Figure 3.5: LTE-U SDL channel selection mechanism [23].

LTE Rel. 10/11 procedures, if interference is found in the operating channel and there is another cleaner channel available. Channel selection is usually good enough to meet the coexistence requirements in most of Wi-Fi and LTE-U deployments.

In conclusion, secondary cell in unlicensed spectrum using channel selection as the coexistence mechanism, should proceed the following steps; select least interfering channels, monitor channel usage periodically, re-select new channels if necessary, and avoid the channel with strong LTE-U links of other operators as much as possible.

3.2.2 Carrier-Sensing Adaptive Transmission

As we previously mentioned, in some high-density deployment of Wi-Fi and LTE-U small cells, the chance of finding a clean channel is low. In such cases, LTE-U can share the channel with neighbouring Wi-Fi or another LTE-U system by

using an adaptive duty cycle or CSAT (Carrier-Sensing Adaptive Transmission) algorithm. Regular co-channel coexistence mechanisms in unlicensed bands such as LBT regulations and CSMA (Carrier Sense Multiple Access) used by Wi-Fi are based on the idea of contention-based access. In such mechanisms, transmitters are expected to sense the medium and make sure that it is clean before transmission. The aim of all these algorithms is to provide coexistence across different technologies in a TDM fashion.

LTE-Advanced in unlicensed spectrum uses a third mechanism (CSAT) which is in line with the same idea of TDM coexistence based on medium sensing. In CSAT, the small cell senses the medium for longer duration than LBT and CSMA duration which is around 10s of msec to 200msec, and according to the observed medium activities, the algorithm gates off LTE transmission proportionally. Specifically, CSAT determines a time cycle where the small cell transmits in a fraction of the cycle and gates off in the remaining duration. The duty cycle of transmission vs gating off is dominated by the sensed medium activity of other technologies. Characteristically, CSAT is similar to CSMA except that it has longer latency, which can be reduced by preventing channels that Wi-Fi APs use for discovery signals and QoS traffic, for instance, primary channels.

CSAT assures productive and friendly channel sharing, with the impact of a LTE-U node to its neighbouring Wi-Fi APs no worse than a neighbouring Wi-Fi AP.

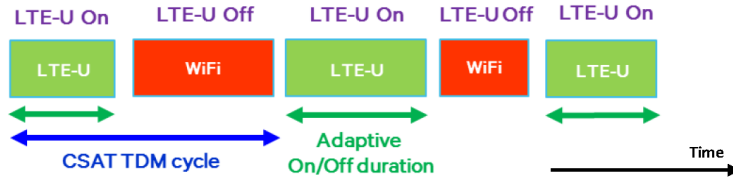

Figure 3.6: LTE-U CSAT function [23].

The LTE-U, located on the secondary cell, is periodically activated and deactivated using LTE MAC Control Elements. The procedures and timeline are carefully chosen to ensure compatibility with Rel. 10/11 UE behaviour. The channel is clean to neighbouring Wi-Fi with normal Wi-Fi transmissions, during the LTE-U off period. The small cell will measure Wi-Fi channel utilization during the LTE-U off period, and adaptively adjust On/Off duty cycle accordingly as is shown in Figure 3.6 [23].

3.2.3 Opportunistic Supplementary Downlink (SDL)

In the opportunistic SDL coexistence mechanism, the SDL carrier in unlicensed band can be used on an opportunistic base, since the anchor carrier in licensed band is always accessible. In the case when the DL traffic of the small cell exceeds a certain threshold and there are active user within the unlicensed band coverage area, the SDL carrier can be turned on for offloading. The SDL carrier is turned off, when there is no user within the unlicensed band coverage area, or the traffic load

can be managed by the primary carrier alone. Opportunistic SDL decreases the interference from continuous RS transmission from LTE-U in unlicensed channel, results in interference reduction in and around a shared channel.

Opportunistic secondary cell off in unlicensed band makes the SCell in OFF-state, and it is the best coexistence mechanism when SCell is not required such as no UE in SCell coverage or there is no data in buffer for users in SCell coverage.

The SCell configuration and activation procedure follows 3GPP Rel-10 specifications and capabilities, according to [20]. While SCell is activated, the UE expects SCell ON-state and OFF-state from eNB, and this means UE activation may span multiple SCell ON-state and OFF-state cycles. The UE shall try to monitor the DL subframes on a subframe basis at least from the 8th subframe after the subframe including the activation MAC CE (Control Element) command. The maximum SCell ON-state duration shall not be greater than 20ms, in order to assure good channel coexistence with delay sensitive transmissions from other nodes. If there is data in user's buffer, the minimum SCell ON-state duration should not be less than 4ms. MIB (Master Information Broadcast) and LDS (LTE-U Discovery Signal) only transmissions can be 1ms. The minimum SCell OFF-state duration is 1ms, and the maximum SCell OFF-state duration is defined by the LDS periodicity. If the UE is requested to report the SCell CQI via aperiodic request, while the UE is unable to perform reliable channel measurements, for instance, when UE

decides that SCell is OFF-state during measurements or while activation actions are still in progress, the UE shall report CQI as zero. Only aperiodic CQI requests should be used. Deactivation MAC CE (Control Element) command are sent independently of the LTE-U SCell ON-state or OFF-state. UE should not be needed to monitor DL subframes (except LDS) after receiving the deactivation MAC CE command from eNB.

3.2.4 LTE Blank Subframe Allocation

The problem of spectrum scarcity has led us to create dynamic spectrum access, which suggests that spectrum should be accessed according to the demand of each system. The use of digital terrestrial television (DTT) unused spectrum in a given area, known as TVWS (TV white spaces) has paved the way to fulfill dynamic spectrum access. In many countries, like US, and Canada, so many efforts have been made to alter regulatory aspects to permit the operation of the white space devices (WSDs).

The collaborative coexistence of LTE and Wi-Fi operate in license-exempt basis on TVWS or 900MHz is analyzed in [25].

According to [25], collaborative coexistence mechanisms require mutual agreement of parameters used in each network. Figure 3.7 illustrates the operation of a collaborative coexistence mechanism in which both networks need to exchange

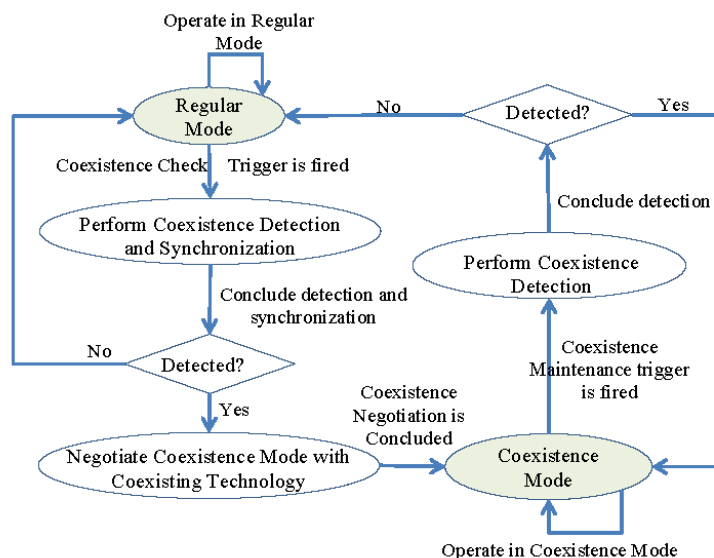

Figure 3.7: Collaborative coexistence procedure [25].

messages to negotiate a coexistence mode. In this procedure, two operation modes have been assumed, namely, Regular Mode, and Coexistence Mode. Regular Mode, which is normal operation of the communication system, assume that no other technology is accessing the spectrum at that location. Some action will trigger the coexistence detection periodically or triggered by an external event, such as an increase in the received interference or detection of a beacon of other technology. In the case of coexistence detection, two results will be discovered. One of the result is the detection and identification of another secondary system, and the other result is synchronization with the identified system. If another network is recognized, both networks sharing the spectrum band will negotiate parameters in a way that fair

coexistence is possible. During the negotiation phase, each system could transmit its coexistence prerequisites, in order to minimize the transmissions. After negotiation phase, each system changes its parameters to support fairly coexistence, referred to as Coexistence Mode. The system will be in coexistence mode as long as all the shared resources are occupied, otherwise the system returns to Regular Mode [25].

LTE time domain coexistence mode has been used in LTE and Wi-Fi coexistence using TVWS. Actually, LTE gives up some time resources (subframes) in a way that coexistence with Wi-Fi is possible. As mentioned before, MAC layer differences has created the severe problem for LTE and Wi-Fi coexistence. While LTE users are scheduled in successive frames with specific power, Wi-Fi users competed for channel access based on sensing the channel energy, using DCF (Distributed Coordination Function). In LTE and Wi-Fi coexistence network using the same channel, some of Wi-Fi nodes may be blocked by LTE, since LTE interference levels are above the Wi-Fi threshold used to detect channel vacancy. Channel vacancy detection threshold for Wi-Fi transmission is set to -82dBm, and for LTE transmissions is set to -62dBm [25]. In case the Wi-Fi nodes get the channel, they may interfere with LTE nodes, since Wi-Fi packets are transmitted with maximum power.

According to [25], the results of single-floor, and multi-floor indoor scenarios

show that an LTE only scenario outperforms the Wi-Fi only scenario with higher throughput per user, because of the differences between the MAC layer methods, time-domain multiplexing versus contention-based strategy, and the fact that LTE nodes are transmitting in consecutive frames, while Wi-Fi users sensing the channel successively to get the chance to access the channel and avoid collision (CSMA/CA). In coexistence scheme, when both LTE and Wi-Fi networks are in regular mode with no blank subframes, LTE has more power over Wi-Fi with high throughput. As LTE is releasing some blank subframes to make fair coexistence with Wi-Fi, the LTE throughput reduction is proportional to the blank subframes periods, and Wi-Fi non-linear throughput development is expected, because of CSMA/CA nature of Wi-Fi, which Wi-Fi wastes time, given by LTE, to listen to the channel.

In conclusion, the coexistence of contention based technology, like Wi-Fi, is profoundly diminished when coexisting with time-domain based (scheduled) network, like LTE. By blanking some of the LTE's subframes and providing Wi-Fi with more time resources, fair coexistence of both technologies is possible. On one hand, Wi-Fi performance increases by allocating some of the LTE's blank subframes, on the other hand, LTE performance reduces, because of not having enough time subframes and having interference of Wi-Fi users. As a result, by considering the both networks deployment, and spatial node distribution, seamless trade off can be done to get a sufficient number of blank subframes.

3.3 Experimental Results

Considering LTE-U Forum methodology [20], including the FDD carrier aggregation (CA) for SDL, and duty cycle coexistence mechanism for LTE in 5GHz band, by using NS-3 (Network Simulator 3), different experiments will be run to test the hypothesis provided by LTE-U Forum, as well as two self-defined scenarios (2-SC, 4-SC). According to [20], LTE-U Forum hypothesis states that “LTE-U transmissions will cause severe interference on Wi-Fi relative to Wi-Fi transmissions, without providing suitable coexistence mechanisms”. We will prove this hypothesis by running experiment using NS-3, in subsection 3.3.3.1. In this section, experimental results will be considered. This section is organized as follows. In Section 3.3.1 scenario and methodology will be covered. Channel access schemes used in our experiment will be elaborated in Section 3.3.2. Coexistence results will be illustrated in Section 3.3.3.

3.3.1 Scenario and Methodology

In this section, scenarios and methodology of our experimental coexistence evaluation between different technologies in the unlicensed band will be covered. The following scenarios for coexistence evaluation are considered.

- 2-SC indoor scenario

- 4-SC indoor scenario

As illustrated in Figure 3.8, in the 2-SC indoor scenario, there are two cells deployed by two operators in the same region which their communication affects mechanisms like CCA (Clear Channel Assessment) and MCS (Modulation and Coding Scheme). The 4-SC indoor scenario will be considered in the next chapter. The available technologies are LAA (Licensed Assisted Access) on EARFCN 255444, frequency band 252 at 5180MHz, and Wi-Fi 802.11n serving on channel 36 at 5180MHz. In this scenario, there is two operator, like operator A, and operator B, each of them operating on a single cell. Each cell includes one BS (Base Station) and a UE (User Equipment). Any one of the operators can use any one of the technologies, such as LTE-U, LAA, and Wi-Fi. When one of the operators uses LTE, the BS is considered to be an eNB and the UE as a UE. In case, where one of the operators uses Wi-Fi, the BS is considered as an AP and the UE as a STA. There is also a connection between backhaul node and BS, which transfers data in the downlink from backhaul to UEs. In our throughput evaluation, throughput of Wi-Fi is used as a metric to evaluate the impact of LAA's interference on Wi-Fi performance. In our experiments, the LAA transmissions always transmits, which is similar to the transmission of LTE-A in licensed bands.

Since LTE-U design was described in the previous chapter, now we will consider experimental parameters in the following section. There is d_1 distance between BS

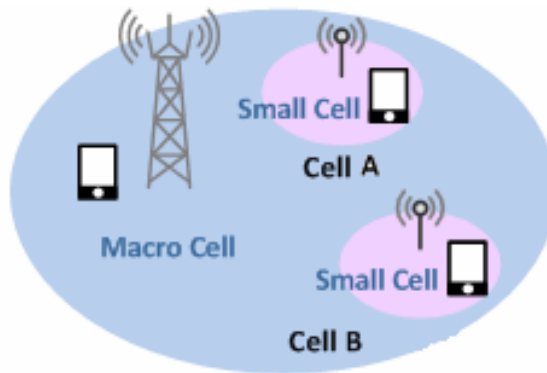

Figure 3.8: 2-SC indoor scenario.

and UE (intra-cell separation), and d_2 distance between each cells (inter-cell separation) in meters. There are some arguments to set the configuration, in command line or in the source, like *cellConfigA* or *cellConfigB* can be configured to be LAA, LTE-U, or Wi-Fi. Table 3.1 lists the default settings of LTE-U/LAA and Wi-Fi parameters. Table 3.2 shows the NS-3 parameters for 2-SC indoor scenario. Using NS-3, some of the parameters are as follow:

- *ftpLambda* : which is the lambda value for FTP model 1 application
- *RngRun* : which is the run number used to modify the global seed
- *RngSeed* : which is the global seed of all Rng streams
- *transport* : which is whether to use 3GPP Ftp, Udp, or Tcp
- *udpPacketSize* : which is the packet size of UDP application

- *udpRate* : which is the data rate of UDP application

In the simulation, a constant bit rate UDP flow of 75Mb/s is used in each operators. Therefore, UDP transfers are used from backhaul to BSs. The simulation data rate is 75Mb/s, and we are using 2x2 MIMO. We are using either FTP or TCP file transfer application, for data transfer. The coexistence cases are as follows:

- Wi-Fi/LTE-U coexistence
 - Wi-Fi/Wi-Fi coexistence
 - Wi-Fi/LTE-U coexistence
- LTE-U/LTE-U coexistence

In Wi-Fi/LTE-U coexistence case, for each cell, first we evaluate performance metrics for two Wi-Fi coexisting in the given scenario, and then Wi-Fi is replaced with LTE-U by one of the Wi-Fi operators, and performance metrics of the Wi-Fi network coexisting with LTE-U network will be evaluated. This result will be used to evaluate the LTE-U and Wi-Fi networks coexistence in an unlicensed spectrum. In LTE-U/LTE-U coexistence case, performance metrics of two coexisting networks using LTE-U, will be evaluated. This result will be used to evaluate the coexistence of two LTE-U networks in an unlicensed band.

3.3.1.1 Performance Metrics

In this section, we cover the metrics which are used for coexistence performance evaluation in our simulation. The metrics are as follows.

- User throughput : the received amount of data on a flow divided by the time difference between the last and first packet received.

$$\text{User throughput} = \frac{\text{The received amount of data}}{\text{Time difference between the last and first packet received}}$$

- TxOffered : the amount of data sent on a flow divided by scheduled duration of data transfer.
- SINR (Signal-to-Interference-and-Noise) : While Wi-Fi node SINR distribution is dependent on preamble decoding, LTE-U SINR distribution is not related to decoding. According to [20] SINR for the i-th node of AP j of operator k for TTI t is as follows:

$$\text{SINR}_{i,j,k,t} = \frac{s_{i,j,k,t}}{N_{th} + \sum_{l \in \Theta(t)} I_{i,j,k,l,t}}$$

Received signal power from AP j is $s_{i,j,k,t}$, thermal noise at node i is N_{th} , received signal power from the interfering node or AP l is $I_{i,j,k,l,t}$, and $\Theta(t)$ is all of the interfering nodes transmitting during a TTI t. The $\Theta(t)$ is empty, if a node does not have any transmission during a TTI t.

3.3.2 Channel Access Schemes

In this section, first the overall design of channel access scheme will be described, and then we summarize different kinds of channel access schemes used in our simulation. Therefore, the channel access schemes used in our scenario, can be categorized as follows. Section 3.3.2.1 covers LTE channel access scheme. Section 3.3.2.2 recaps duty cycle channel access scheme, and Section 3.3.2.3 includes LBT channel access scheme.

The comprehensive LBT channel access design is illustrated in Figure 3.9 [29]. As it is shown, `WifiNetDevice` and `LteEnbNetDevice` are connected together by the same spectrum channel. The LTE device has an object called *ChannelAccessManager* which has objects to listen to `WifiPhy` transitions. The *ChannelAccessManager* also has connection to LTE Mac and Phy. The Phy connection, allows the Phy to request the channel and get access to the channel by channel access manager. To register a callback on trace to get HARQ feedback, Mac connection is used. ED (Energy Detection) threshold can be set differently on the channel access device.

The default *Channel AccessManager* permits the LTE device to transmit whenever it needs. The *ChannelAccessManager* is designed specifically for backoff mechanisms used in LBT, as `LbtAccessManager`. Using two different helpers, we are able to create different kinds of channel access schemes. The main helper used for

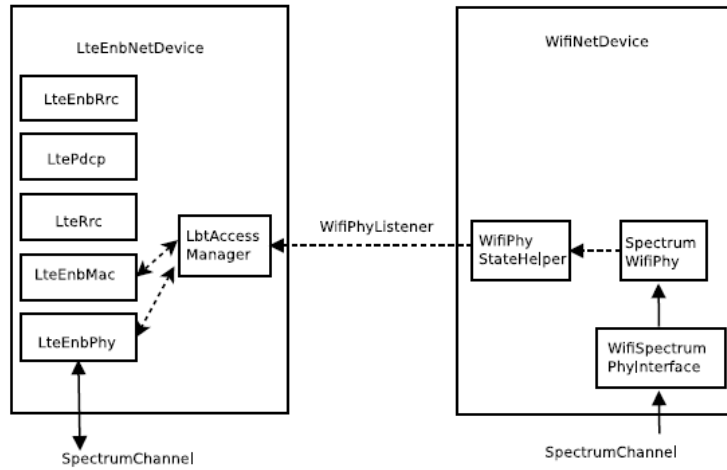

Figure 3.9: Basic LBT channel access design [29].

configuring the two networks is called `ScenarioHelper`, and while the `LaaWifiCoexistenceHelper` is used to configure LBT on LTE eNB devices.

3.3.2.1 LTE Design

As we mentioned before, *ChannelAccessManager* is responsible for defining the channel access mechanism. The *Default* mechanism is that, whenever LTE eNB needs the channel, the channel will be granted and eNB will start transmission. This is due to the fact that LTE does not have any specific channel access mechanism. In LTE module, a new class as *ChannelAccessManager* has been added. This class is connected to `LteEnbRrc` which then configures and notifies `LteEnbMac` and `LteEnbPhy` about the presence of *ChannelAccessManager*. Each LTE eNB device

has its own instance of `LteEnbRrc`, and therefore, its own `ChannelAccessManager` instance. `ChannelAccessManager` can take one of three values (`Default`, `DutyCycle`, and `Lbt`). To sum up, `Default` or `BasicLbtAccessManager` grants the channel whenever LTE eNB needs the channel, and also has a mechanism where the backoff time is constant or static, like EU LBE LBT, which we will introduce in the next chapter.

3.3.2.2 Duty Cycle Design

To implement the LTE duty cycle, `DutyCycleAccessManager` has been created as a subclass of `ChannelAccessManager` class. `lteDutyCycle` parameter can be used to change the value of LTE duty cycle. LTE throughput will increase by rising the LTE duty cycle value. In this section, we have used this channel access mechanism in the simulation. In `src/laa-wifi-coexistence/model` directory, you can find `DutyCycleAccessManager` channel access model.

3.3.2.3 LBT Design

`LbtAccessManager` is another class which is inherited from `ChannelAccessManager` class, which implements listen-before-talk mechanism and exponential backoff according to [28]. We will expand this topic in detail in the next chapter, and base on this channel access scheme, we will run the simulation in the next chapter. In

src/laa-wifi-coexistence/model directory, you can find *LbtAccessManager* channel access model.

3.3.3 Coexistence Results

According to 3GPP findings in [28], it was believed that the most difficult scenario which LBT design can be tested on accurately, was the single carrier case. Most of the researchers considered the results of single carrier scenario in compared with four carrier scenario, which was not as challenging as the single case. Single carrier scenario makes the most contention to access the channel between the devices. In addition, indoor scenario attracted more attention than outdoor case. Based on these facts, in the following section, we will find the result of indoor high loaded single carrier scenario.

3.3.3.1 Evaluation Results for 2-SC Indoor Scenario

One node (UE), one small cell per operator in a single carrier scenario are assumed. By running the simulation for different random layout of the UEs (by random variable), average user throughput results are calculated and plotted in Figure 3.10. Baseline coexistence scenario is Wi-Fi/Wi-Fi coexistence scenario. Wi-Fi/LTE coexistence scenario refers to LTE in unlicensed spectrum without any coexistence solution. Wi-Fi/LTE-U shows coexistence scenario with duty cycle channel ac-

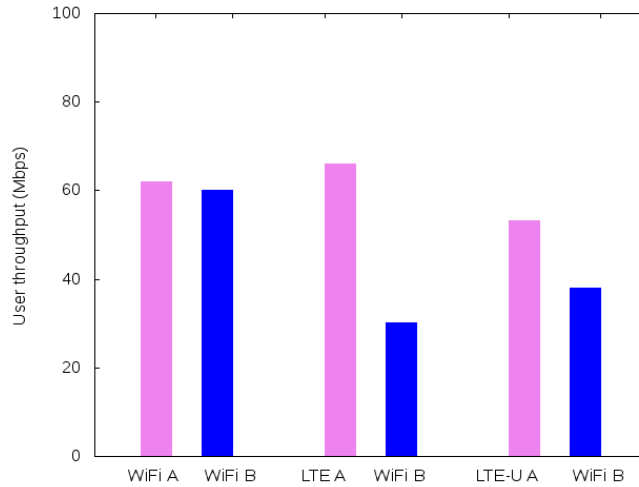

Figure 3.10: User throughput comparison.

cess mechanism. Figure 3.10 proves LTE-U Forum hypothesis, which states that “ LTE-U transmissions will cause severe interference on Wi-Fi relative to Wi-Fi transmissions, without providing suitable coexistence mechanisms” [20]. It is clear that, with the proper coexistence scheme, LTE-U transmissions does not affect Wi-Fi transmissions considerably.

3.3.3.2 Radio Environment Map of 2-SC Indoor Scenario

In this section, Radio Environment Map (REM) will be plotted for each of the coexistence scenarios, including Wi-Fi/Wi-Fi, Wi-Fi/LTE, Wi-Fi/LTE-U, LTE-U/LTE-U coexistence scenarios. REM is a uniform two dimensional grid of values that illustrate the SINR (Signal-to-Interference-and-Noise) in the downlink with

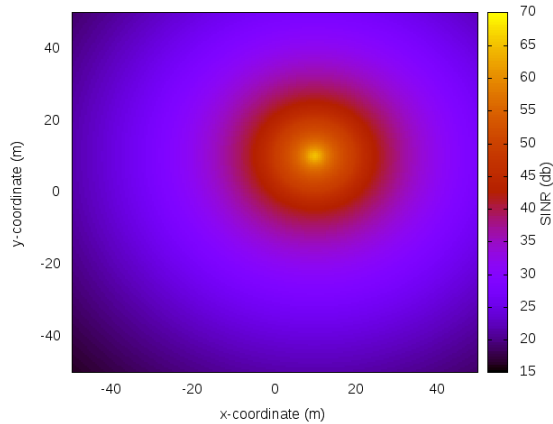

Figure 3.11: Wi-Fi/LTE radio environment map (no coexistence solution).

respect to eNB which has the strongest signal at each point. It is also possible to generate REM for a specific RbId. The default RbId is -1, which means that the generated REM is based on the average SINR from all RBs.

By the means of a small gnuplot script, we will be able to plot the REM. REM for Wi-Fi/LTE, Wi-Fi/LTE-U, LTE-U/LTE-U coexistence scenarios are plotted in Figure 3.11, Figure 3.12, and Figure 3.13 respectively. It is worth mentioning that Wi-Fi/Wi-Fi coexistence scenario does not have REM, since REM is only define for LTE network scenarios which there is at least one AP. Wi-Fi user SINR distribution is dependent on preamble decoding, while LTE-U SINR distribution is independent of decoding.

As it is clear, in Figure 3.13, since we have two different eNBs, we will see two different SINR in the downlink with respect to different strongest eNBs. In

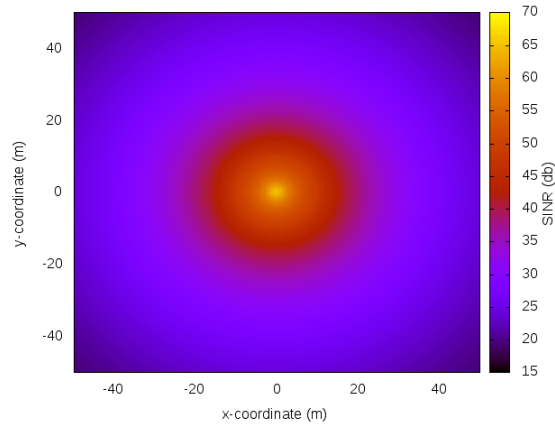

Figure 3.12: Wi-Fi/LTE-U radio environment map.

addition, in Figure 3.13, there is no outage between the small cells, and in case of heavy traffic, if there is not any available unlicensed band for LTE, LTE will be switched to the licensed band to meet the customer demands.

As it is shown in Figure 3.11 and Figure 3.12 there is only one SINR, since there is only one strongest eNB at each small cell. It goes without saying that, since there is no eNB in Wi-Fi/Wi-Fi coexistence scenario, there is no REM either. In Figure 3.11, since there is no coexistence solution which ensures the fairness between two technologies, it is obvious that the strongest signal at each small cell belongs to LTE network and not Wi-Fi network, which confirms the politeness behavior of Wi-Fi.

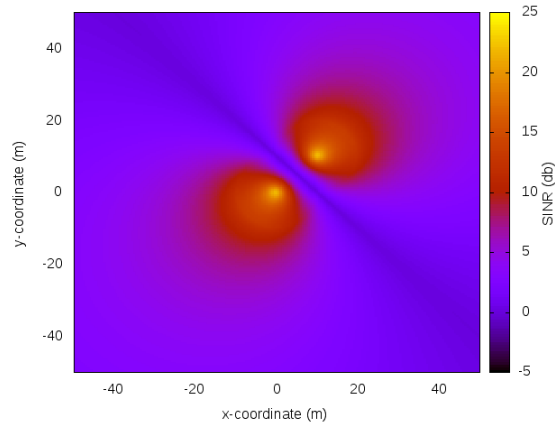

Figure 3.13: LTE-U/LTE-U radio environment map.

3.3.3.3 Observations

The simulation observations is as follow.

- Wi-Fi/LTE coexistence scenario which refers to LTE in unlicensed spectrum without any coexistence mechanism, causes serious performance degradation on coexisting Wi-Fi.
- Wi-Fi/LTE-U coexistence scenario which uses duty cycle coexistence solution to access the channel, slightly outperforms Wi-Fi/Wi-Fi scenario, thus LTE-U is a comparable or better neighbor to Wi-Fi compared to Wi-Fi as a neighbour, since LTE-U outperforms the replacing Wi-Fi slightly.
- LTE-U/LTE-U marginally outperforms Wi-Fi/Wi-Fi scenario, since duty cycle coexistence mechanism has been used as a coexistence solution.

To sum up, LTE-U is a better neighbour to Wi-Fi than a Wi-Fi neighbour. On one hand, LTE has better coverage and is more reliable. These features are available by the sake of compressing the control information bits and decreasing the coding rates. In compare to Wi-Fi, the control bits in LTE, like acknowledgement bits has been minimized. The code rate of LTE is less than 0.1, while that of Wi-Fi is fixed to 0.5. As a result, wider coverage and much more reliability of the control channels in LTE, make LTE-U a target goal for mobile users. On the other hand, LTE is more powerful to handle the unstable interference and uncertain radio environments. HARQ in LTE make it possible to improve the retransmission performance in compare to ARQ in Wi-Fi network.

3.3.3.4 Evaluation Results for 2-SC Indoor Scenario in Congested Area

Having one small cell per operator in single carrier scenario, and increasing the number of users (UEs) per small cell in dense environment, average user throughput evaluation of LTE-U small cell and Wi-Fi is demonstrated in Figure 3.14. As has been plotted, The throughput of LTE-U small cell, while using duty cycle channel access scheme, has decreased by increasing the number of users. Generally, LTE-U small cell has higher throughput than Wi-Fi, while duty cycle channel access scheme is used.

As it is illustrated in Figure 3.15, in Wi-Fi/Wi-Fi coexistence simulation sce-

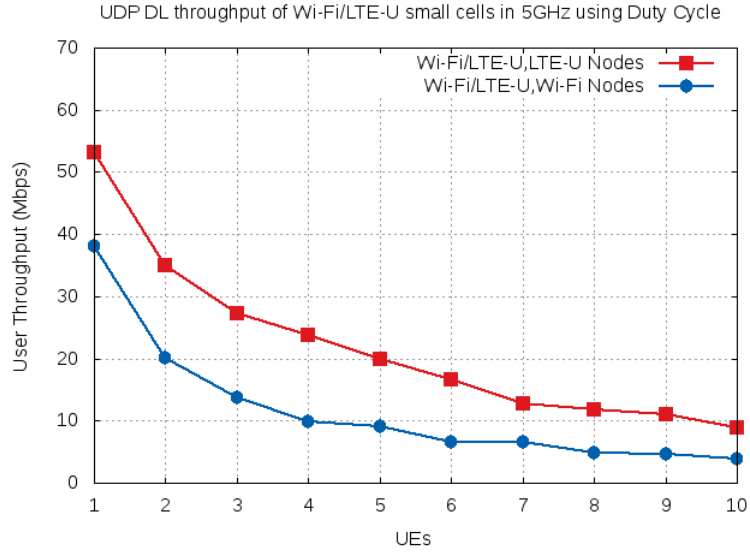

Figure 3.14: Throughput evaluation of Wi-Fi/LTE-U for 2-SC in dense area.

nario where duty cycle channel access scheme is used, the Wi-Fi throughput of operator B (node B or small cell B) is greater than operator A (node A or small cell A) for 4 users. When there are more users, in congested areas, the Wi-Fi throughput of node A and B are fluctuated. By comparing the two figures (Figure 3.14 and Figure 3.15), we will understand that for a single user, the Wi-Fi/Wi-Fi scenario has higher throughput than Wi-Fi/LTE-U coexistence simulation scenario, but in general, it has concluded that LTE-U is a better neighbour to Wi-Fi compared to Wi-Fi as a neighbour, since LTE-U outperforms the replacing Wi-Fi significantly.

In the third coexistence case, LTE-U/LTE-U simulation scenario, where there are two LTE-U networks in a congested area, while using duty cycle channel access

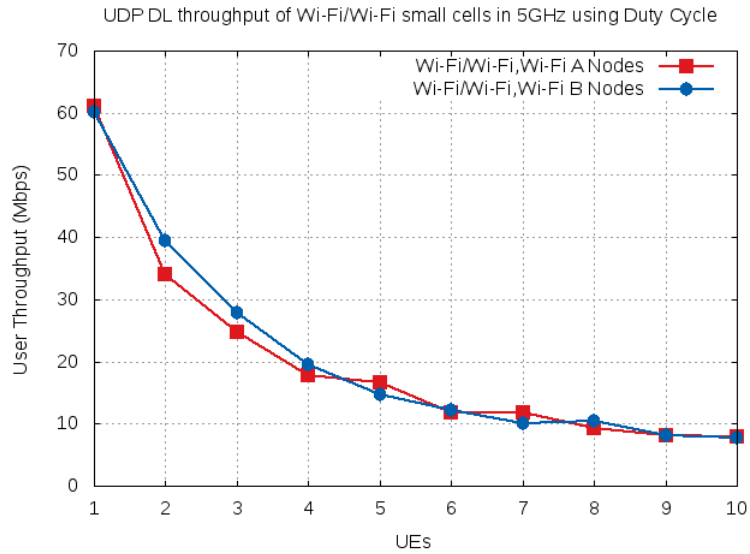

Figure 3.15: Throughput evaluation of Wi-Fi/Wi-Fi for 2-SC in dense area.

scheme, the evaluation results is plotted in Figure 3.16. As is shown, both LTE-U networks experience low throughput. This throughput will reduce by increasing the users in congested area, where both networks are high demand and there is busy traffic as well. As is illustrated, while there is high throughput for two users in network B, two users in network A experience a very low throughput. In general, the throughput of both networks reduce with high traffic.

3.3.3.5 Overall User Throughput

By having evaluated different scenarios for 2-SC in congested area, overall user throughput will be obtained. Figure 3.17 shows downlink overall throughput for

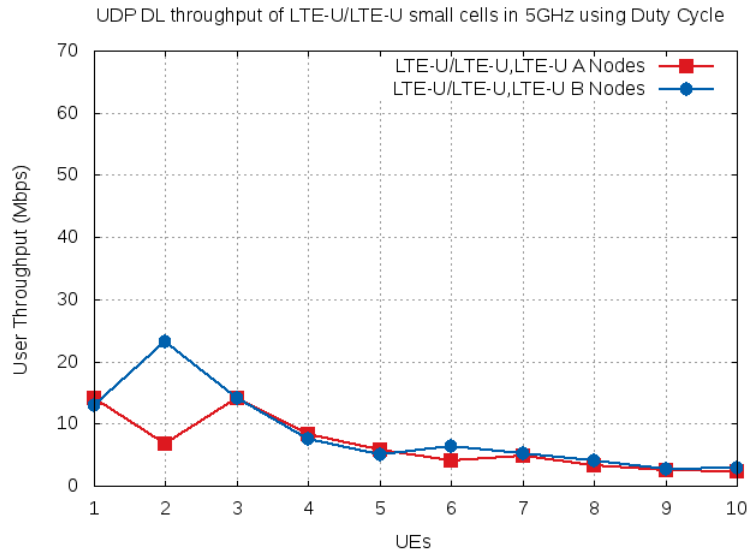

Figure 3.16: Throughput evaluation of LTE-U/LTE-U for 2-SC in dense area.

three different 2-SC indoor scenarios, like Wi-Fi/LTE-U, Wi-Fi/Wi-Fi, and LTE-U/LTE-U. As it is obvious, LTE-U/LTE-U has the minimum overall throughput compare to other scenarios.

3.4 Summary

In this chapter, as simulation results proved, LTE-U is a good neighbour to Wi-Fi, while it expands the efficiency of LTE into unlicensed spectrum by increasing the spectral efficiency, wider coverage, and reliability. We have simulated a standard network of LTE and Wi-Fi nodes, which follows the 3GPP Rel-10. By evaluating the down-link only LTE-U network, the following results have obtained:

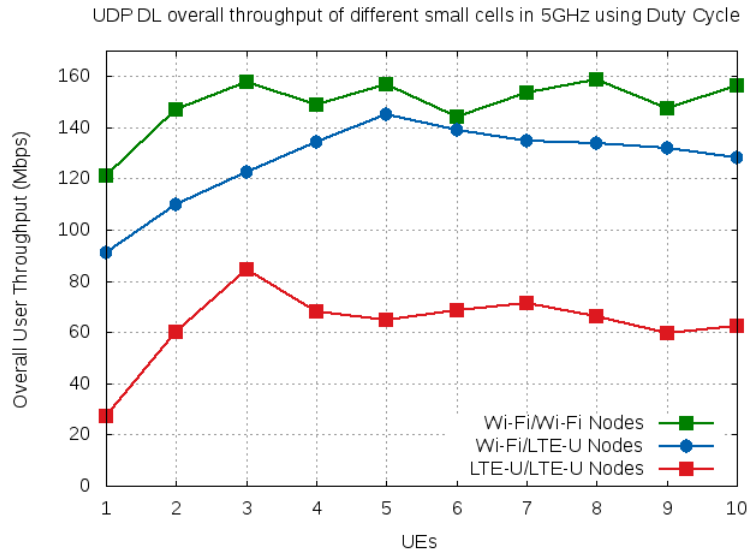

Figure 3.17: DL overall throughput evaluation of different scenarios for 2-SC in dense area.

1. The mixture of LTE link efficiency (like HARQ) and MAC efficiency (due to frequency reuse) cause performance improvement, when substituting LTE or Wi-Fi bearer selection by LTE and LTE-U carrier aggregation.
2. In a Wi-Fi deployment, if a part of the Wi-Fi network substitutes with LTE-U nodes, the Wi-Fi network will provide customers with better performance, in compare to the case where all Wi-Fi nodes are available.

The LTE-U high performance, and best neighbour for Wi-Fi, are due to rigorously designed coexistence mechanisms, like channel selection, duty cycle, oppor-

tunistic secondary cell off in unlicensed spectrum.

In this chapter we first introduced 5GHz unlicensed band as a supplemental spectrum for LTE in licensed band. Then coexistence mechanisms such as channel selection, CAST, opportunistic SDL, and ABS are provided. By running simulations, some experimental results have proved that LTE-U is the better neighbour to Wi-Fi than other Wi-Fi neighbour. It is worth mentioning that, the carefully designed coexistence mechanism, plays an important role in the performance of LTE-U.

In the next chapter, we will introduce the other coexistence technique called Listen Before Talk (LBT). Then, experimental results will be provided.

Table 3.1: Default experimental configurations

Parameters	Default settings
Center frequency	5.180GHz
LTE-U/LAA band	252
LTE-U/LAA bandwidth	20MHz
LTE-U/LAA modulation scheme	16-QAM
Wi-Fi standard	802.11n
Wi-Fi channel	36
Wi-Fi bandwidth	20MHz
Transport protocol	UDP
Intra-cell distance	10m
Inter-cell distance	50m
UDP packet size	1000bytes
UDP rate	75000000bps
Antenna type	Isotropic
Antenna gain	3dBi
LTE-U/LAA CCA-ED threshold	-72dBm

Table 3.2: NS-3 parameters for 2-SC indoor scenario

Parameters	Default settings	Description
ftpLambda	0.5	Packet arrival rate
cellConfigA	Lte	Cell A type
cellConfigB	Wifi	Cell B type
ChannelAccessManager	DutyCycle	Channel access type
Intra-cell distance	10m	intra-cell separation
Inter-cell distance	10m	inter-cell separation
UDP packet size	1024bytes	UDP application packet size
Number of carriers	1	One carrier per operator
cwUpdateRule	nacks80	Rule to update CW of LTE-U
lteDutyCycle	1	Duty cycle value for LTE-U
wifiStandard	80211nFull	Wi-Fi standard type

4 Licensed Assisted Access (LAA) Supplementary Downlink (SDL) Coexistence with LBT

In the previous chapter, LTE-U SDL coexistence mechanisms were introduced in the regions without LBT requirements, which are compatible with the current LTE standard, and can increase the advantage of LTE Release 10/11. In this chapter, we will discuss the LTE-U SDL coexistence mechanisms in the countries where LBT requirements are essential, and LTE design modifications should be done to make coexistence with other technologies a reality. These modifications have been proposed in 3GPP as a component of the LTE Release 13. This chapter is organized as follows. In Section 4.1, we will consider LBT overview. Section 4.2 will describe the differences between Wi-Fi LBT and EU LBE LBT. LTE design modifications for LBT is introduced in Section 4.3. 3GPP LBT design is elaborated in Section 4.4. Experimental results is covered in Section 4.5. Summary is concluded in 4.6.

4.1 Listen-Before-Talk (LBT) Overview

As discussed in previous chapters, in some regions such as India, Japan, and Europe, some regulations are needed to control the channel periodically for existence of other inhabitant in the channel by listening before transmitting (talking). This regulation is called Listen Before Talk (LBT). Therefore, in these markets, unlicensed spectrum users should use LBT to gain the channel. LBT is believed to be the most troublesome to implement, but the most reasonable to make fair coexistence with Wi-Fi possible. As we explained in detail before, Wi-Fi MAC layer strategy uses Distributed Coordination Function (DCF), or Enhanced Distributed Channel Access (EDCA) based on the Wi-Fi selection, which is a how Wi-Fi uses LBT. In Europe regulations, two options for LBT schemes have been provided [26]. The first option is to use the Wi-Fi version for LBT, or in other word, to use the DCF or EDCA as mentioned in Wi-Fi standards. The second option is to use one of the two types of adaptive schemes, which are the Load Based Equipment (LBE) scheme, and the Frame Based Equipment (FBE) scheme [26]. LBE is much more to Wi-Fi LBT, and most of the companies eager to use LBE version of LBT. The differences between LBE and FBE scheme, will be considered in sections 4.1.1, and 4.1.2 according to Harmonized European Standard (ETSI EN 301 893 V1.7.1 (2012-06)).

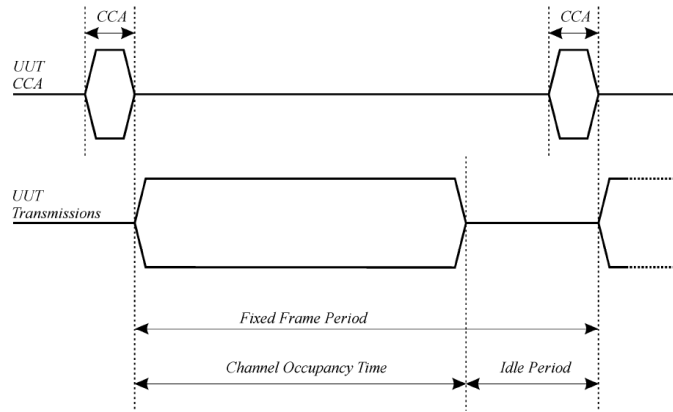

Figure 4.1: Frame Based Equipment (FBE) schedule [26].

4.1.1 Frame Based Equipment(FBE) Scheme

As defined in ETSI EN 301 893 V1.7.1 (2012-06) Figure 4.1, Frame Based Equipment has some regulation which need to be followed:

1. The first vital requirement is to verify if the channel is clear by using Clear Channel Assessment (CCA) based on energy detection of the channel, once there is an open channel for transmission. The minimum duration of CCA investigation on the operating channel is $20\mu\text{s}$, which is defined by manufacturer. The equipment can start transmission if the operating channel is sensed to be clear. If the channel energy level is above the threshold relating to the power level (in item 5), the channel will be marked as busy.
2. In case of a busy operating channel, transmissions can be done after the next

Fixed Frame Period. In case of multiple transmissions on different operating channel at one time, CCA investigation should be done for any other operating channel.

3. Channel Occupancy Time is defined as the complete time in which that equipment is operating on the channel except the CCA investigation time. Channel Occupancy Time should be in the range of 1ms to 10ms. 5% of the Channel Occupancy Time in the current Fixed Frame Period is considered to be the minimum Idle Period.
4. Based on the packet destined to the equipment, CCA can be replaced by control and management frames, like ACK frames, under the condition that transmission period is not longer than Maximum Channel Occupancy Time. In case of multicast, the ACK can be done in a chain.
5. The ultimate transmit power (P_H) of a transmitter determines the CCA energy detection threshold (TL). The CCA energy detection threshold level formula is : $TL = -73\text{dBm/MHz} + 23 - P_H$. As an example, the CCA energy detection threshold for a transmitter with 23dBm maximum transmit power, is equal or less than -73dBm/MHz.

LBT requirements for Frame Based Equipment in Europe has been illustrated in Figure 4.2 by 3GPP [26].

Parameter	Requirement	Comment
Clear Channel Assessment (CCA) time	Minimum 20 μ s	
Channel Occupancy time	Minimum 1 ms, maximum 10 ms	
Idle period	Minimum 5% of channel occupancy time	
Fixed frame period	Equals to Channel Occupancy time + Idle Period	
Short control signaling transmission time	Maximum duty cycle of 5% within an observation period of 50ms	Part of Channel occupancy time
CCA Energy detection threshold	Assuming receive antenna gain G=0dBi: If EIRP=23dBm at transmitter Threshold \leq -73 dBm/MHz Otherwise (different transmit power levels, PH) Threshold = -73(dBm/MHz) + 23(dBm) - PH(dBm)	For WAS/RLAN

Figure 4.2: LBT parameters for Frame Based Equipment (FBE) [26].

4.1.2 Load Based Equipment(LBE) Scheme

Load Based Equipment is a scheme where the transmission and reception structure is demand-driven, and is not fixed in time. LBE uses a channel sensing mechanism with dynamic timing. Based on the CCA (Clear Channel Assessment), LBE make an LBT common band, with the help of energy detection as described in IEEE 802.11 ETSI EN 301 893 V1.7.1 (2012-06). Figure 4.3 demonstrates the EU LBE LBT backoff process [26]. LBE has all the regulations mentioned in FBE, and in addition, it has the following regulations as well:

- In case of a busy operating channel, no transmission should be done, and Extended CCA investigation should be performed for the duration of a random factor Q multiplied by the CCA duration time (20 μ s). Therefore, Extended CCA = Q * 20 μ s, where Q is a random number in the range from 1 to q at each Extended CCA stored in a counter, and q is chosen by manufacturer in

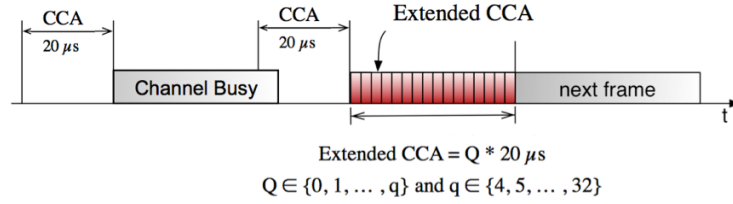

Figure 4.3: EU LBE LBT static backoff process [26].

the range from 4 to 32. The best coexistence parameter for q is 32; in other words, $q=32$ is the coexistence friendly case. Q represents the number of idle slots, producing Idle Period, and demonstrates the time that needs to be considered before any transmission. The counter will decrement, each time that channel is sensed idle. When the counter reaches zero, the equipment can transmit.

- Channel Occupancy Time is defined as the complete time in which that equipment is operating on the channel except the CCA investigation time. The maximum Channel Occupancy Time should be smaller than $((13/32) * q)$ ms.

LBT requirements for Load Based Equipment in Europe have been illustrated in Figure 4.4 by 3GPP [26].

Parameter	Requirement	Comment
Clear Channel Assessment (CCA) time	Minimum 20 μ s	Also referred to as CCA time slot
N (number of clear idle slots) in extended CCA	N shall be randomly selected in the range 1..q every time, q=4...32	
Channel Occupancy time	$\leq (13/32) \times q$ ms	
Idle period	At least the duration of a random factor N multiplied by the CCA time slot.	
Short control signaling transmission time	Maximum duty cycle of 5% within an observation period of 50ms	Part of Channel occupancy time
CCA Energy detection threshold	Assuming receive antenna gain G=0dB: If EIRP=23dBm at transmitter Threshold ≤ -73 dBm/MHz Otherwise (different transmit power levels, PH) Threshold = $-73(\text{dBm/MHz}) + 23(\text{dBm}) - \text{PH}(\text{dBm})$	For WAS/RLAN

Figure 4.4: LBT parameters for Load Based Equipment (LBE) [26].

4.2 Wi-Fi Listen-Before-Talk (LBT) Vs. European Load Based Equipment Listen-Before-Talk (EU LBE LBT)

As Figure 4.3 demonstrates [26], the fundamental difference between Wi-Fi LBT and EU LBE LBT is their backoff process. Extended CCA in EU LBE LBT is a *Static Backoff*, since Q uses a static range from zero to q slots, and each slot is 20 μ s. As we mentioned previously, the value of q has been selected by the manufacturer, so the value of Extended CCA is always constant for a given product. Therefore, there would be no increase in value of q in the case of collision. On the other hand, Wi-Fi uses *Exponential Backoff* which is variable for a given product and each time that a station encounters a collision, it will double the contention window. Wi-Fi slots are 9 μ s. Figure 4.5 illustrates Wi-Fi LBT exponential backoff process used by DCF. In DCF the exponential backoff process is also called binary exponential

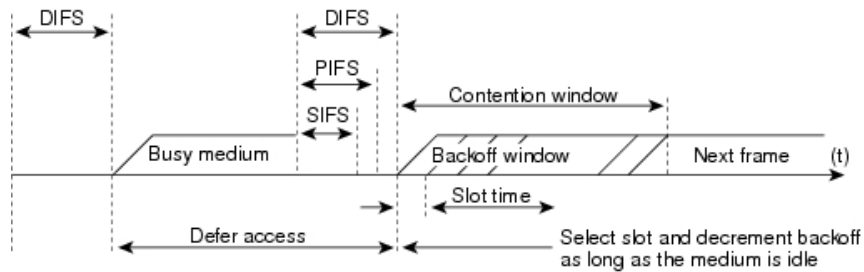

Figure 4.5: Wi-Fi LBT exponential backoff process used by DCF [26].

backoff. At first the contention window has CW_{min} value, and it increases each time that transmission fails, and no ACK is received. After a failed transmission, the backoff will have a CW value from $2 * (CW + 1) - 1$ to CW_{max} . After a successful transmission, the backoff value will reset to CW_{min} . Understanding the Wi-Fi LBT and EU LBE LBT differences, we will consider LAA and Wi-Fi coexistence simulation scenarios and their results in section 4.2.1.

4.2.1 Simulation Results

Based on the simulation, we will consider the differences between Wi-Fi LBT using exponential backoff and EU LBE LBT using static backoff [26]. The simulation parameters are: UDP full buffer traffic, 20MHz co-channel, AIFS=3, and $CW_{min} = 15$. In this simulation, some of the nodes follow the Wi-Fi LBT using exponential backoff, while some other nodes are using EU LBE LBT protocol with static backoff

and ultimate backoff range ($q=32$), which is the best value while coexisting with other technologies in a common channel. Two operators (operator A, and operator B) with different number of stations (UE) following Wi-Fi and/or EU LBE LBT rules in three different scenarios, within the same channel has been considered :

1. Both two operators are following Wi-Fi rules.
2. Operator A is using Wi-Fi rules, and operator B is using LAA-LBT, with 15 stations (UEs) per operator.
3. Operator A is using Wi-Fi rules, and operator B is using LAA-LBT, with 20 stations (UEs) per operator.

The first scenario is used as the baseline for comparison [26]. There is good coexistence environment in the second and third scenarios, compare to the first scenario, provided that we have only four stations (UEs), or fewer, per operator. As we increase the number of nodes per operator, typically in dense conditions, we will see the poor coexistence environment in comparison with the first scenario. As is clear in Figure 4.6, in the second scenario, with 15 stations per operator, there is increase in LAA users and decrease in Wi-Fi users. Therefore, there is not strong coexistence between operator A, and operator B. We will see the poor coexistence in the third scenario as well by increasing the number of stations per operator, or by decreasing the value of q . It is worth mentioning that transmission success rate

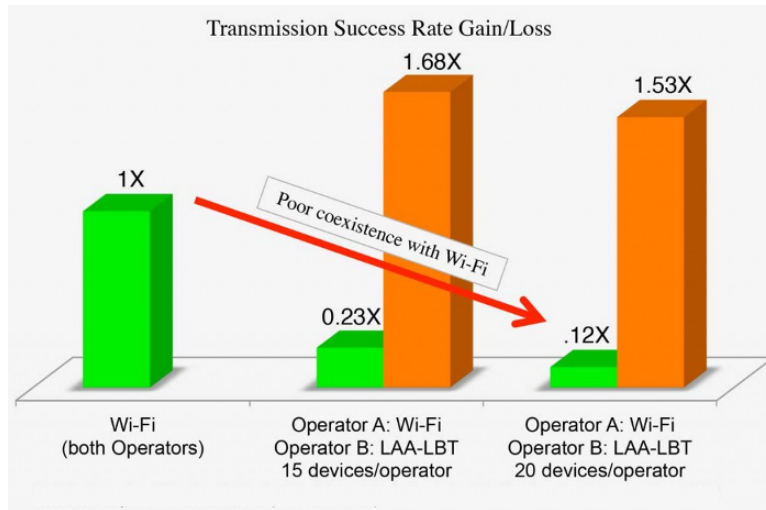

Figure 4.6: Three simulation scenarios [26].

is the probability of any client to send a successful burst (pass CCA investigation, and transmit without collision).

By looking closer to EU LBE LBT, we will come to the conclusion that although many companies who insist on fair coexistence of LTE and Wi-Fi, found that EU LBE LBT is the safest way to provide the customers with friendly coexistence at least in the worst scenarios, there are some ideas that have concentrated on the constrained and non-adaptive backoff range of EU LBE LBT. In the dense environments, this characteristics of EU LBE LBT causes more customers tend to select a common backoff range, which results in more collisions and negative performance. Therefore the rules of ETSI EN 301 893 V1.7.1 (2012-06) LBT are not useful for fair coexistence of LTE and Wi-Fi. It has been suggested to use Wi-Fi

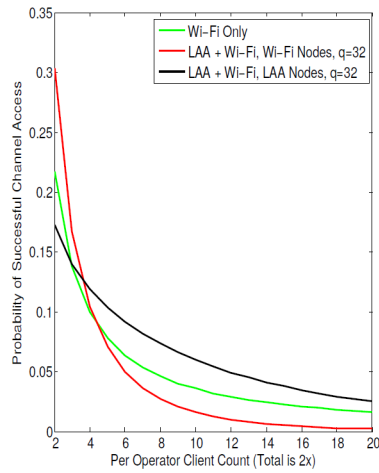

Figure 4.7: Successful transmissions of LBE LBT and Wi-Fi coexistence scenario [27].

LBT (DCF/EDCA), which is based on CSMA/CA using exponential backoff [27]. The Wi-Fi alliance has also proposed a proposal to ETSI and suggested to use LBT with exponential backoff for LAA. According to [27], it has been suggested to consider LDPC (Low Density Parity Check), and 256 QAM for LAA, since the lower order modulation makes longer frame duration. Longer frame period means an increase in the backoff period and a decrease in the channel utilization for other users. Including VoIP and other traffic types, RTS/CTS, and evaluating the coexistence of LTE and Wi-Fi in dense environments are other suggestions proposed by [27].

Successful packet transmission of the scenarios where LBE LBT and Wi-fi are coexisting has been illustrated in Figure 4.7. As is clear, for less than 5 clients per operator, Wi-Fi performs better compared to EU LBE LBT. For more than 5 clients per operator, LAA clients have higher successful transmission rate compared to Wi-Fi clients. It is worth mentioning that the lower the q is, the worse the performance. In this scenario the value of q is 32 [27].

4.3 LTE modifications for Listen-Before-Talk (LBT)

According to [23], there should be some LTE design modifications to meet the requirements in LBT areas. Some of these modifications which should be done in LTE PHY and MAC are as follows :

- In order to meet regional requirements in Europe and Japan, LBT using Clear Channel Assessment (CCA) should be done.
- In order to reserve the channel for transmission following LBT, beacon signals should be designed.
- To identify, get access to the channel, and for multiple PLMNs (Public Land Mobile Network), discovery signals should be added.
- DL and UL waveform should be modified in order to enable LBT and to identify channel occupancy definition.

- HARQ protocol should be changed, since in asynchronous HARQ design, there is no guarantee to access the channel.

All the above modifications will be considered in 3GPP meeting and in LTE Release 13.

4.3.1 Simulation Results

Two simulation scenarios has been studied in [23] in order to evaluate the performance of LTE in unlicensed spectrum using LBT. The macro cell sites for both scenarios are co-located. Two operators (A, and B) were studied in each scenario. Operators using their LTE Advanced network with HetNet + Wi-Fi as baseline of comparison. In the first scenario, each operator deploys its picocells placed uniformly with 16-picocell. In the second scenario, they deploy picocells deployed in a hotspot region with clustered 8-picocell. The PCell is in the same licensed band as the macro cell, and SCell is Wi-Fi. In the first scenario, picocells are deployed in a macrocell coverage area and are not in the same sites. In the second scenario, two-thirds of users are dropped within a hotspot of 70m radius, and the other one-third of users is dropped uniformly in the macrocell acreea.

Figure 4.8 shows DL median throughput gains in 16 picocells uniformly dropped in each cell per operator [23]. Having LTE HetNet licensed band and Wi-Fi as our baseline for comparison, we will not consider any reduction in the performance of

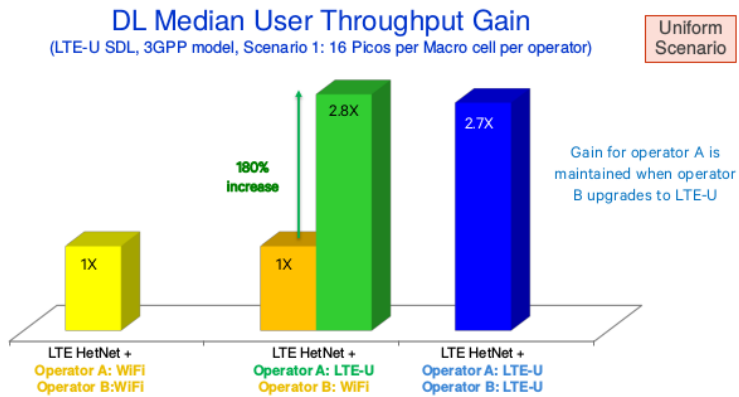

Figure 4.8: DL median throughput gains in uniform scenario [23].

operator B, but there is 180% throughput increase if operator A replaces Wi-Fi with LTE-U, and will experience a median throughput of 2.8x of the baseline. In the case where both operators deploy LTE-U, throughput gain of operator A will not change while operator B replaces with LTE-U, and median user throughput gain would be 2.7x of the baseline.

Figure 4.9 shows DL median throughput gains in clustered 8 picocells [23]. As is clear from the figure, replacing Wi-Fi with LTE-U increases the median throughput gain as well. While operator A replaces Wi-Fi with LTE-U, the performance of operator B remains somehow the same in compare to baseline, and throughput gain of operator A increases by 300%, and reaches to 3.8x of baseline. When both operators deploy LTE-U, their throughput gains reach to 3.7x of baseline. Therefore, this figure illustrates the advantage of LTE-U in dense environments.

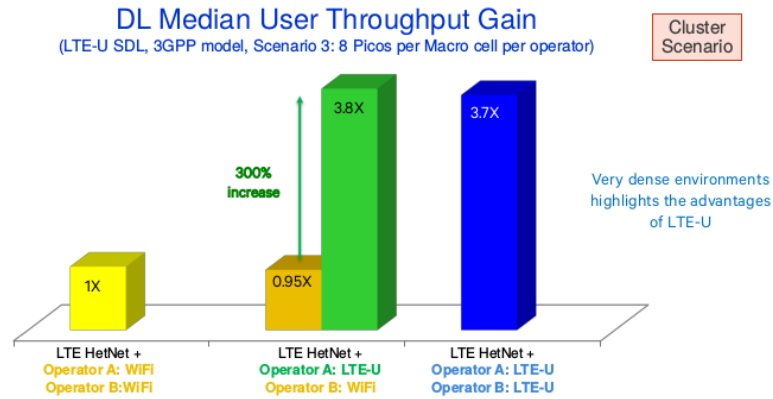

Figure 4.9: DL median throughput gains in cluster scenario [23].

In conclusion, in countries where LBT regulations are mandatory, LTE design modifications can make coexistence possible, and these modifications have been proposed in 3GPP to put in practice in Release 13 LTE standard.

4.4 3rd Generation Partnership Project (3GPP) Listen-Before-Talk (LBT) Design

According to 3GPP TR 36.889 V13.0.0 (2015-06), to have fair coexistence of LAA with other technologies using unlicensed band, the presence of LBT is essential. To verify whether the channel is busy or available for use, LBT mechanism on a node wishing to transmit on a carrier using unlicensed band should do a CCA (Clear Channel Assessment) by ED (Energy Detection). In some regions, like Europe, energy detection threshold has been chosen in a way that all the node should follow

the threshold such that if a node receives energy greater than that, it means the channel is busy. In some cases, a node may use a lower threshold than that was specified optionally. In the case of LAA, 3GPP has recommended to use energy detection threshold adaptively, especially for DL, where it is better that energy detection threshold drops to the lower threshold that was specified before. Static threshold or semi-static threshold setting can also be available.

In [28] 3GPP has suggested to use Category 4 LBT as the baseline for at least DL transmissions having PDSCH (Physical Downlink Shared Channel). Channel access scheme can be grouped by 4 categories as follows:

- Category 1 (No LBT): There is no LBT mechanism to verify a clear channel before a transmission.
- Category 2 (LBT without random backoff): There is a fixed period of time that the channel is sensed to be available before a transmission.
- Category 3 (LBT with random backoff with a fixed contention window size): There is a fixed contention window size. The contention window has the minimum and maximum value of random number N (Q in Figure 4.3), that a transmitting node draws. The random number N (Q in Figure 4.3) determines the period of time that channel is sensed to be free before a transmission. In other words, the random number N (Q in Figure 4.3) is the number of slots

that a transmitting node must sense as idle before transmitting.

- Category 4 (LBT with random backoff with a variable contention window size): This category is based on the Wi-Fi medium access protocol. Like Wi-Fi LBT, there is a variable contention window size. The contention window has the minimum and maximum value of random number N (Q in Figure 4.3), that a transmitting node draws. The transmitting node can change the size of the contention window when draws the random number N (Q in Figure 4.3). The random number N (Q in Figure 4.3) determines the period of time that channel is sensed to be free before a transmission. In other words, the random number N (Q in Figure 4.3) is the number of slots that must be sensed as idle before transmitting.

4.5 Experimental Results

In this section, simulation results will be considered. Since the general part of the scenario, methodology, and channel access schemes are covered in the previous chapter, in this chapter we will describe them in detail. This section is organized as follows. The scenario and methodology will be covered in section 4.5.1. Section 4.5.2 will elaborate channel access scheme used in our experiment. Section 4.5.3 will recap the coexistence results of 2-SC and 4-SC coexistence simulation scenarios.

4.5.1 Scenario and Methodology

In order to evaluate the coexistence of different networks in unlicensed band, in this section, the scenario and methodology used in our experiment will be covered. In general there are two different scenarios: indoor and outdoor. The Indoor scenario has attracted more attention in the literature than the outdoor scenario, thus we will concentrate on indoor scenario. 2-SC and 4-SC are some examples of indoor scenarios. 2-SC indoor scenario is covered in detail in the previous chapter, thus 4-SC indoor scenario will elaborate in this chapter in detail as well.

Since LTE-U design was described in chapter 2, now we will consider experimental parameters for 4-SC indoor scenario. Table 4.1 lists NS-3 parameters for 4-SC indoor scenario. Figure 4.10 illustrates the 4-SC indoor scenario [29]. As shown, in 4-SC indoor scenario, there are two operators which deploy four small cells each in the $120*50m^2$ one-floor building, and 20 users or UEs relating to each operators (5 UEs per small cell per operator). The locations of the BS are fixed, and they offset from one another by 5 meters by default. In this scenario, we do not consider UE mobility, and the locations of UEs can be altered by changing the random variable run number (RngRun), and random variable seed (RngSeed). The small cells of each operator are evenly spaced and centred along the longer dimension of the building. There is random distance between two nearest nodes of

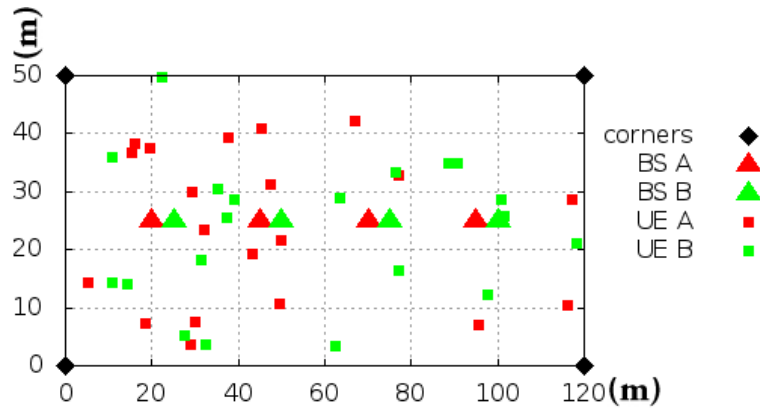

Figure 4.10: 4-SC indoor scenario [29].

the two operators. There is 25m spacing between two BS of the same operator.

The available technologies are LAA (Licensed Assisted Access) on EARFCN 255444, frequency band 252 at 5180MHz, and Wi-Fi 802.11n serving on channel 36 at 5180MHz. In this scenario, there are two operators, like operator A, and operator B, where each of them has four small cells. Each cell includes one BS (Base Station) and 5 UEs (User Equipment). Any one of the operators can use any one of the technologies, either LAA or Wi-Fi. When one of the operators uses LAA, the BS is considered to be an eNB and the UE as a UE. In case, where one of the operators uses Wi-Fi, the BS is considered as an AP and the UE as a STA. There are some arguments to set the configuration, in command line or in the source, like `cellConfigA` or `cellConfigB` can be configured to be LAA, LTE-U, or Wi-Fi. In the simulation, a constant bit rate UDP flow of 75Mb/s is used in each operators.

Therefore, UDP transfers are used from backhaul to BSs. The simulation data rate is 75Mb/s, and we are using 2x2 MIMO. We are using either FTP or TCP file transfer application, for data transfer. The coexistence cases are as follows:

- Wi-Fi/LAA coexistence
 - Wi-Fi/Wi-Fi coexistence
 - Wi-Fi/LAA coexistence
- LAA/LAA coexistence

In Wi-Fi/LAA coexistence case, for each cell, in the first step, we evaluate performance metrics for two Wi-Fi coexisting in the given scenario, and then in the second step, Wi-Fi is replaced with LAA by one of the Wi-Fi operators, and performance metrics of the Wi-Fi network coexisting with LAA network will be evaluated. This result will be used to evaluate the LAA and Wi-Fi networks coexistence in an unlicensed spectrum. In the LAA/LAA coexistence case, performance metrics of two coexisting networks using LAA will be evaluated. This result will be used to evaluate the coexistence of two LAA networks in an unlicensed band.

4.5.1.1 Performance Metrics

In this section, we cover the metrics which are used for coexistence performance evaluation in our simulation. Like the previous chapter, the metrics are as follows.

- User throughput : the received amount of data on a flow divided by the time difference between the last and first packet received.

$$User\ throughput = \frac{The\ received\ amount\ of\ data}{Time\ difference\ between\ the\ last\ and\ first\ packet\ received}$$

- TxOffered : the amount of data sent on a flow divided by scheduled duration of data transfer.
- SINR (Signal-to-Interference-and-Noise) : While Wi-Fi node SINR distribution is dependent on preamble decoding, LTE-U SINR distribution is not related to decoding. According to [20] SINR for the i-th node of AP j of operator k for TTI t is as follows:

$$SINR_{i,j,k,t} = \frac{s_{i,j,k,t}}{N_{th} + \sum_{l \in \Theta(t)} I_{i,j,k,l,t}}$$

The received signal power from AP j is $s_{i,j,k,t}$, thermal noise at node i is N_{th} , received signal power from the interfering node or AP l is $I_{i,j,k,l,t}$, and $\Theta(t)$ is all of the interfering nodes transmitting during a TTI t. The $\Theta(t)$ is empty if a node does not have any transmission during a TTI t.

- User Perceived Throughput (UPT) : UPT CDF (Cumulative Distribution Function) is defined as the average of all its file throughput. File throughput is calculated per file. In UPT calculation, unfinished files should be considered, that is, we divide the number of served bits of an unfinished file captured at

the end of the simulation by the served duration time (end of simulation time minus file arrival time).

- Buffer Occupancy (BO) : BO of the i -th UE is defined as the sum of the time period in which UE queue is not empty. In other words, UE has some data to transmit plus retransmissions divided by total simulation time.

4.5.2 Channel Access Scheme

Section 4.4 covered the four categories for channel access schemes, which is used in our simulations. In addition, the overall design of channel access scheme was covered in the previous chapter. In this chapter, we will describe LBT channel access scheme that is used in our simulation. LBT channel access manager was covered in general in the previous chapter. As we mentioned, *ChannelAccessManager* can take one of three values (*Default*, *DutyCycle*, and *Lbt*). *Default* or *BasicLbtAccessManager* implements an LBT channel access mechanism where the backoff time is constant or static, like EU LBE LBT. On the other hand, *Lbt* or *LbtAccessManager* implements a mechanism where the backoff time is random, this channel access manager is similar to Wi-Fi LBT or Wi-Fi CSMA/CA. We will introduce *LbtAccessManager* more in detail in the following section. Section 4.5.2.1 will elaborate LBT channel access scheme.

4.5.2.1 LBT Channel Access scheme

As we mentioned before, *LbtAccessManager* is another class which is inherited from *ChannelAccessManager* class, which implements listen-before-talk mechanism and exponential backoff according to 3GPP in [28]. The *LbtAccessManager* channel access model is found in `src/laa-wifi-coexistence/model` directory. According to [29], *LbtAccessManager* connects its listeners to *WifiPhy* and *MacLow*. Therefore, to configure the *LbtAccessManager* we need to do the following.

```
Ptr < LbtAccessManager > lbtAccessmanager = Create < LbtAccessManager >  
lbtAccessmanager-> SetupPhyListener(wifiPhy);  
rrc-> SetChannelAccessManager(lbtAccessManager);
```

With the help of *LaaWifiCoexistenceHelper*, we will be able to set up *LbtAccessManager*. Therefore, we will call *LaaWifiCoexistenceHelper*. The configuration of LBT is done in the `ConfigureLaa` function located in the `ScenarioHelper`. It is worth mentioning that, *LbtAccessManager* is implementing two different listeners, one for `WifiPhy`, and one for `MacLow`.

4.5.3 Coexistence Results

According to 3GPP findings in [28], it was believed that the most difficult scenario for LBT design which can be tested accurately, was single carrier case. Most of

the researchers considered the results of single carrier scenario in compared with four carrier scenario, which was not as challenging as the single case. Single carrier scenario makes the most contention to access the channel between the devices. In addition, indoor scenario attracted more attention than outdoor case. Based on these facts, in the following section, we will find the result of indoor high loaded single carrier scenario.

Section 5.3.2.1 covers the evaluation results for the 2-SC indoor scenario in the congested area, and Section 4.5.3.2 concentrates on the evaluation results of the 4-SC indoor scenario using different kinds of data traffic models (small file transfers, constant bit rate streams, and voice flows). Based on the data traffic, we will have different kinds of file transfer applications, such as FTP over UDP (Ftp), FTP over TCP (Tcp), and constant bit rate UDP (Udp). Small file transfers and voice flows were mainly used in [28]. We are able to select any kinds of file transfer application (Ftp, Tcp, Udp) by passing command-line argument `--transport =< mode >`. For FTP over UDP, Ftp should be passed to command-line argument. For FTP over TCP, Tcp should be passed, and for constant bit rate UDP, Udp should be passed to `--transport`. We will elaborate main classes of data traffic and file transfer applications in Section 4.5.3.2 in detail. This section is organized as follows. Section 5.3.2.1 covers 2-SC simulation results, and Section 4.5.3.2 describes 4-SC experimental results.

4.5.3.1 2-SC Simulation Results

As we mentioned before, there are two coexistence cases to evaluate in our simulation. These two coexistence scenarios are as follows:

- Wi-Fi/LAA coexistence
 - Wi-Fi/Wi-Fi coexistence (step 1)
 - Wi-Fi/LAA coexistence (step 2)
- LAA/LAA coexistence

In the first step of Wi-Fi/LAA coexistence simulation scenario (Wi-Fi/Wi-Fi), we evaluate the performance of two Wi-Fi technologies, coexisting in the given scenario, in the congested area, while using LBT channel access scheme. Figure 4.11 illustrates Wi-Fi/Wi-Fi coexisting in the 2-SC scenario. As it is plotted, the Wi-Fi throughput of operator B (node B or small cell B) is greater than operator A (node A or small cell A) for 4 users. In dense area, where there are lots of users, the Wi-Fi throughput of operator A and B are fluctuated. It is worth mentioning that, this figure is the same as Figure 3.15 in the previous chapter, which illustrated the Wi-Fi/Wi-Fi coexisting scenario using duty cycle channel access scheme. This is because duty cycle channel access and LBT channel access scheme play an important role in LTE-U and LAA networks, rather than Wi-Fi networks.

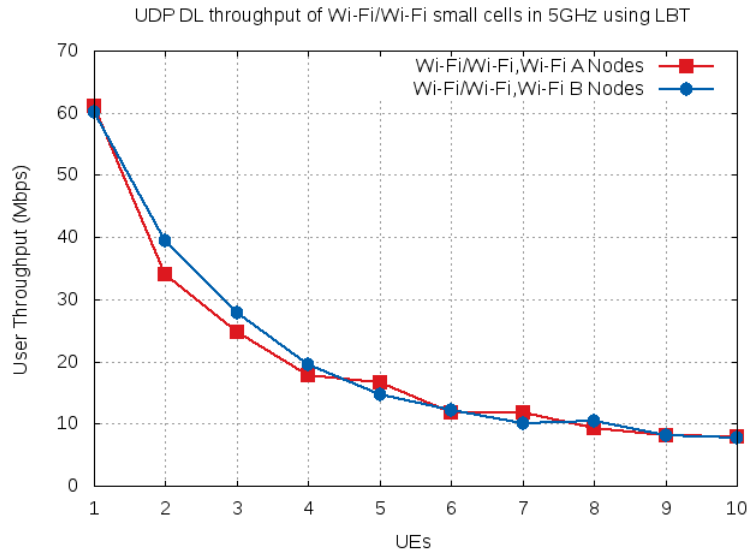

Figure 4.11: Throughput evaluation of Wi-Fi/Wi-Fi for 2-SC in dense area.

In the second step of Wi-Fi/LAA coexistence simulation scenario (Wi-Fi/LAA), one Wi-Fi network replaced by an equivalent LAA network. The evaluation results of Wi-Fi/LAA coexistence simulation scenario in congested area, while using LBT channel access scheme, is plotted in Figure 4.12. As it is illustrated, for a single user, Wi-Fi network has better throughput than LAA. But as the number of users are increasing, LAA outperforms the Wi-Fi network significantly. By comparing the two figures (Figure 4.11 and Figure 4.12), we conclude that LAA is a better neighbor to Wi-Fi compared to Wi-Fi as a neighbor, since LAA outperforms the replacing Wi-Fi significantly.

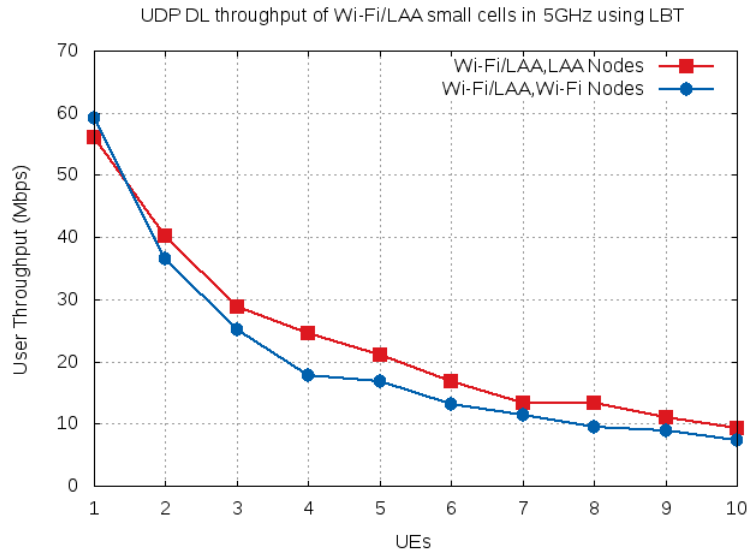

Figure 4.12: Throughput evaluation of Wi-Fi/LAA for 2-SC in dense area.

In the second coexistence case, the LAA/LAA simulation scenario, where there is two LAA networks in congested area, while using LBT channel access scheme, the evaluation results is plotted in Figure 4.13.

Having evaluated Wi-Fi/Wi-Fi, Wi-Fi/LAA, and LAA/LAA for 2-SC in the congested area, the overall user throughput evaluation of all the mentioned scenarios is plotted in Figure 4.14. As is obvious, using LBT coexistence mechanism, our simulation results have confirmed that LAA/LAA is the high-performance coexistence scenario, comparing to other scenarios. In other words, LAA is a better neighbour to Wi-Fi than Wi-Fi itself. It is worth mentioning that LAA can operate in unlicensed band without impacting Wi-Fi more than an equivalent Wi-Fi

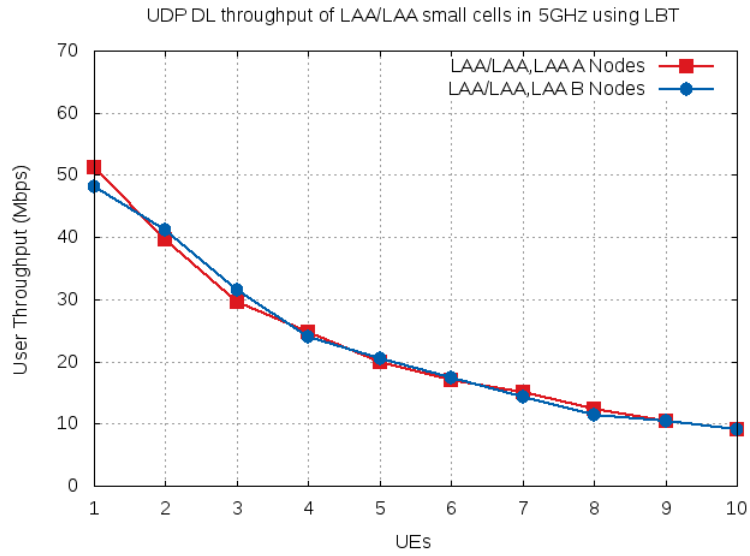

Figure 4.13: Throughput evaluation of LAA/LAA for 2-SC in dense area.

network.

4.5.3.2 4-SC Simulation Results

As Figure 4.10 illustrates the 4-SC coexistence simulation scenario [29], we evaluate the coexistence case as follows:

- Wi-Fi/LAA coexistence
 - Wi-Fi/Wi-Fi coexistence (step 1)
 - Wi-Fi/LAA coexistence (step 2)

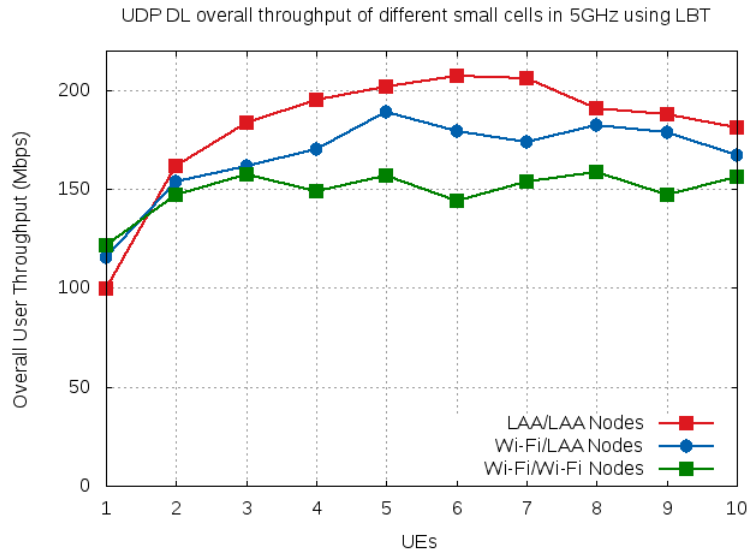

Figure 4.14: DL overall throughput evaluation of different scenarios for 2-SC in dense area.

In step 1, we evaluate the results for Wi-Fi/Wi-Fi scenario, and in the second step, the same scenario with one Wi-Fi network replaced by a LAA network (Wi-Fi/LAA) will be simulated, while considering different traffic models and different file transfer applications. Before running the simulation, and plotting the results, it is worth elaborating the different kinds of traffic models and file transfer applications provided in our simulation.

According to 3GPP [28], LTE quality of service (QoS) differentiates LTE subscribers and services. Premium subscribers should be prioritized over basic subscribers. Real time services like VoIP can be prioritized over non-realtime services.

As we know, premium subscribers need to experience better network quality in compare to basic subscribers. Not only the subscribers but some services need better priority handling in the network, like VoIP, and video. In order to strive to meet this demands, quality of service (QoS) plays an important role. Quality of service (QoS) clarifies priorities for specific customer or services during the high congestion in the network. Quality of service (QoS) in LTE is implemented between UE and Packet Data Network (PDN) Gateway and is applicable to bearers. Bearer is a virtual approach and is a set of configuration that provides specific priority to a set of traffic. For instance, VoIP packets have priority over web browser traffic. Quality of service (QoS) is applicable on radio bearer, S1 bearer, and other bearers.

LTE networks use QoS Class Identifier (QCI) to assign proper quality of service (QoS) to bearer traffic. There is different QCI values, since different bearer traffic needs different QoS. QoS Class Identifier (QCI) is a mechanism that categorizes the different types of bearers of traffic into different classes with suitable QoS parameters for each traffic type. Guaranteed Bit Rate (GBR) or non-Guaranteed Bit Rate (non-GBR), Priority Handling, and Packet Error Loss rate are some examples of the QoS parameters. The default QCI of UE/eNB traffic bearer for non privileged subscribers are usually 9. The lowest priority level traffic will be discarded in case of traffic congestion. QCI-65, QCI-66, QCI-69 and QCI-70 were introduced in 3GPP TS 23.203 Rel-12, according to 3GPP [28].

According to [28], different kinds of traffic models and file transfer applications should be considered, while evaluating the coexistence scenarios. According to [29], there are three kinds of traffic models, such as small file transfers, voice flows, and constant bit rate streams. Based on different traffic models, we can use different kinds of file transfer applications, such as FTP over UDP (Ftp), FTP over TCP (Tcp), and constant bit rate UDP (Udp). -- *transport* command-line argument, provides us with Ftp, Tcp, and Udp modes. Voice application can also be added on top of the above flows. FTP-based applications operate in a non-full buffer traffic model, and transfer files in a bursty manner towards one UE at a time. Unlike FTP-based applications, UDP-based applications operate in a full buffer traffic model, and transfer files in continuous traffic. UDP-based applications transfer files in a continuous manner towards all the UEs in both operators, at the uniform data rate specified. FTP-based applications composed of FTP file transfer over UDP/IP (FTP over UDP application) with transport mode Ftp, and FTP file transfer over TCP/IP (FTP over TCP application) with transport mode Tcp. UDP-based application is constant bit rate streams with transport mode Udp. In the following section, we describe each of these applications briefly.

In our simulation, we use FTP over UDP application (transport mode Ftp), that is, we use Ftp transport mode to transfer files in a burst manner towards one UE at a time over UDP/IP. According to [30], there are two traffic models for FTP,

FTP Model 1, and FTP Model 2. Since we have implemented FTP Model 1 in our simulation, we describe FTP Model 1 briefly.

According to [30], in order to evaluate system throughput, it is suggested that we use continuous traffic with non-varying interference, and full buffer traffic model. It is also suggested that the throughput of the system should be evaluated using time-varying interference by bursty traffic model. The full buffer traffic model applies to continuous traffic, and the non-full buffer FTP models applies to burst traffic. FTP Model 1, and FTP Model 2, are some examples of non-full buffer traffic models. Figure 4.15 illustrates FTP Model 1 traffic generation [30]. FTP Model 1 has two parameters as follows:

- File size (S) : File size is 2Mbytes, and one user downloads a single file. To speed up the simulation, we can use 0.5Mbytes file.
- User arrival rate (λ) : User arrival rate is Poisson distributed with arrival rate λ . For 0.5Mbytes, λ ranges from [0.5, 1, 1.5, 2, 2.5] second(s), and for 2Mbytes, λ ranges from [0.12, 0.25, 0.37, 0.5, 0.625] second(s).

As mentioned above, each operator transfer files according to a Poisson distribution using lambda user arrival rate (λ), which for file size of 0.5Mbytes, it ranges from [0.5, 1, 1.5, 2, 2.5]. It goes without saying that, traffic intensifies as the lambda value increases. Every $1/\lambda$ seconds, a file arrives to transfer. Every



Figure 4.15: FTP Model 1 traffic [30].

operators has its own file generation according to lambda arrival rate, and all the files are emerged from a node in the backhaul network towards one of the UEs. If lambda is 1, it means that every second, one UE will be selected randomly and a file will be transferred from a backhaul network node towards that UE.

In our simulation, the argument `--ftpLambda` will get the desired value for user arrival rate. By default, it is set to 0.5 second. By passing a different value for lambda, we will create different kinds of traffic. By increasing the lambda value, we will experience more intense traffic.

In addition, the argument `--transport` is set as `Ftp`, in order to transfer files in a bursty manner over UDP/IP, and then we calculate the throughput of the system. In the simulation, we have used some sort of IP-based flow monitor tool to keep track of throughput of traffic. The file transfer applications are created in a class called `FileTransferApplication`. We have used IP protocol layer, which is above the Wi-Fi or LTE devices, to measure the throughput of the flows.

```
-----monitorB-----  
Flow 1 (2.0.0.2:49153 -> 7.0.0.6:9) proto UDP  
Tx Packets: 8272  
Tx Bytes: 8503616  
TxOffered: 68.0289 Mbps  
Rx Bytes: 4814124  
Throughput: 22.1684 Mbps  
Mean delay: 452.182 ms  
Mean jitter: 0.542358 ms  
Rx Packets: 4683
```

Figure 4.16: Flow monitor output.

In order to calculate the user perceived throughput, we have used an IP-based flow monitor tool which puts a label on every packet that traverses throughout the network, keep track of their history, and create throughput of every flow. Since the IP-based flow monitor located on top of the Wi-Fi and LTE devices, it uses Wi-Fi and LTE devices informations in order to measure UPT (User Perceived Throughput) of each flow. It is worth mentioning that, in order to let the file transfer application to finish its operation, we allow the simulation to delay a few seconds after the sending process is done. We also do not measure unfinished files in our throughput calculation. For instance, a part of the output of our IP-based flow monitor used in our simulation is illustrated in Figure 4.16.

Each simulation run creates two files, one for operator A and one for operator B, which each includes a summary of statistical data of all flows.

In the first run of our simulation, we follow the step 1 of our 4-SC scenario, where there are two Wi-Fi networks. After running the simulation, the throughput CDF and latency CDF of the 4-SC coexistence simulation scenario for step 1, when there is Wi-Fi/Wi-Fi coexistence technologies in unlicensed band using LBT and FTP file transfer application over UDP/IP connection, has been obtained. It is worth mentioning that the results are correspond to -72dBm LAA energy detection (ED) threshold, and FTP user arrival rate or FTP lambda is 0.5 seconds. Figure 4.17 illustrates CDF evaluation of file transfer throughput for Wi-Fi/Wi-Fi coexistence scenario for 4-SC using FTP over UDP/IP connection.

As we previously mentioned, in IP layer, throughput is defined as the number of received bits divided by the flow receive duration (time interval between the last and first received packet of the flow). IP packet size of UDP-based file transfer applications is 1028 (1000 bytes plus UDP and IP headers). Each flow composed of 354 packets of 1448 payload bytes for IPv4. As Figure 4.17 illustrates both of the two Wi-Fi networks have 110Mbps to 120Mbps throughput.

In the second step of our simulation, where one of the Wi-Fi networks replaced with an equivalent LAA network, the throughput CDF and latency CDF are achieved. Figure 4.18 illustrates CDF evaluation of file transfer throughput for Wi-Fi/LAA coexistence scenario for 4-SC with FTP over UDP/IP. As it is clear, operator A (LAA) has better throughput of 140Mbps. Operator A (LAA) outper-

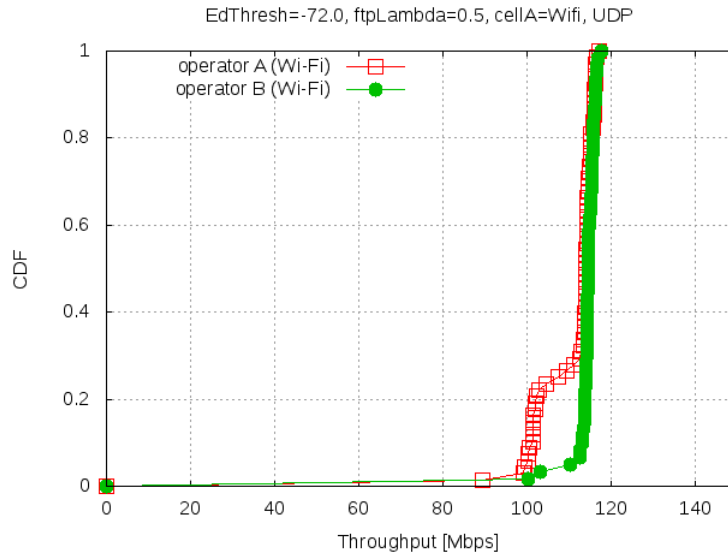

Figure 4.17: Throughput of Wi-Fi/Wi-Fi for 4-SC with FTP over UDP/IP [29].

forms the operator B (Wi-Fi). It is worth mentioning that with 0.5 second for user arrival rate ($ftp\lambda$), we experience a fast traffic.

By comparing the Figure 4.17 and Figure 4.18, we notice that the throughput of the our scenario while Wi-Fi network of operator A is replaced by LAA network, outperforms the operator B (Wi-Fi) with around 140Mbps comparing to 120Mbps in the first step with Wi-Fi/Wi-Fi coexistence network.

Latency evaluation of Wi-Fi/Wi-Fi coexistence scenario for 4-SC and Wi-Fi/LAA coexistence scenario for 4-SC, while using UDP/IP are plotted in Figure 4.19 and Figure 4.20. As it is illustrated, the latency of Wi-Fi/Wi-Fi coexistence simulation scenario ranges up to 30ms, while the latency of Wi-Fi/LAA coexistence scenario

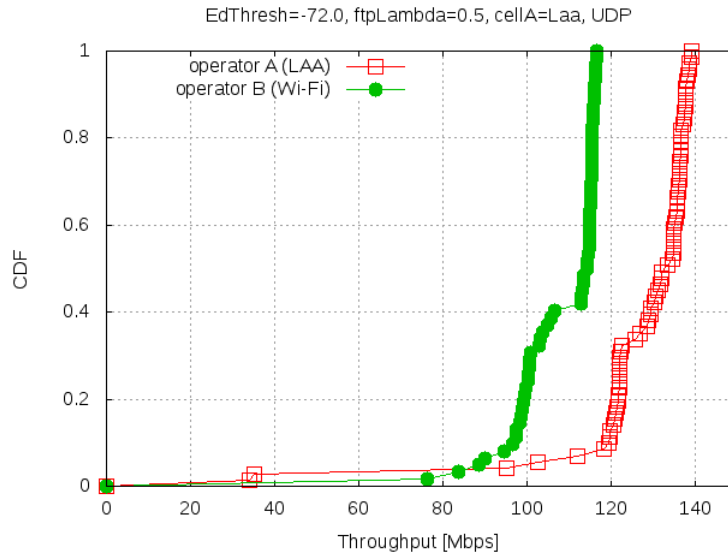

Figure 4.18: Throughput of Wi-Fi/LAA for 4-SC with FTP over UDP/IP [29].

is around 15-29ms, although there is a few outliers values that range up to 90ms. Therefore, Wi-Fi/LAA coexistence scenario has better throughput and less latency in compare to Wi-Fi/Wi-Fi coexistence scenario.

In the second run of our simulation, we have used FTP over TCP application. To do so, argument `--transport` has set to `Tcp`. In comparison with our first simulation run, which FTP over UDP application was used, the only difference is that packets flow over a TCP/IP connection, and all the other configurations are the same as the DUP application. TCP connection is configured in a way that it uses the ns-3 default NewReno congestion control with 1440 bytes segment size and 10 segments for TCP initial congestion window. It is worth mentioning that

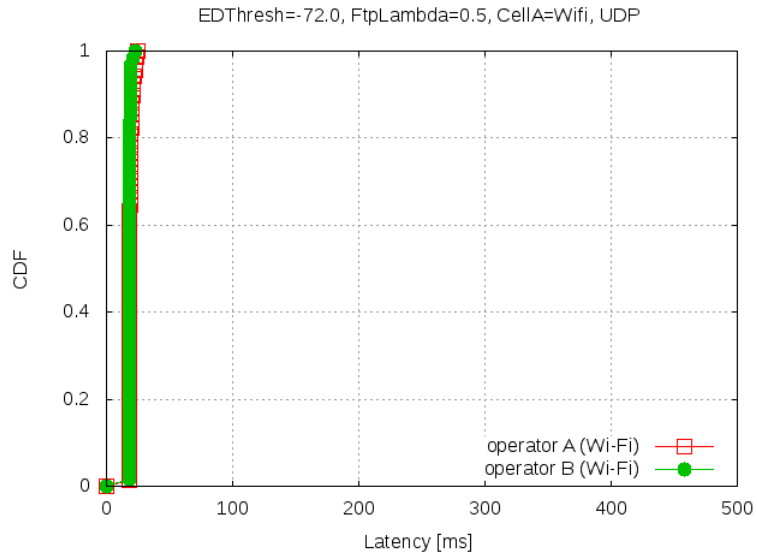

Figure 4.19: Latency of Wi-Fi/Wi-Fi for 4-SC with FTP over UDP/IP [29].

the results are correspond to -72dBm LAA energy detection (ED) threshold, and FTP user arrival rate or FTP lambda is 0.5 seconds. Figure 4.21 illustrates CDF evaluation of file transfer throughput for Wi-Fi/Wi-Fi coexistence scenario for 4-SC using FTP over TCP/IP connection and Figure 4.22 plots throughput CDF of Wi-Fi/LAA coexistence scenario for 4-SC using FTP over TCP/IP connection. In later figure, the scenario is the same as Wi-Fi/Wi-Fi coexistence scenario, but one Wi-Fi network replaced by equivalent LAA network.

Having compared Figure 4.21 and Figure 4.22, we conclude that by replacing LAA with the Wi-Fi network, and using TCP/IP connection, throughput of the system is decreased significantly. The finite buffer mode of TCP connection, and

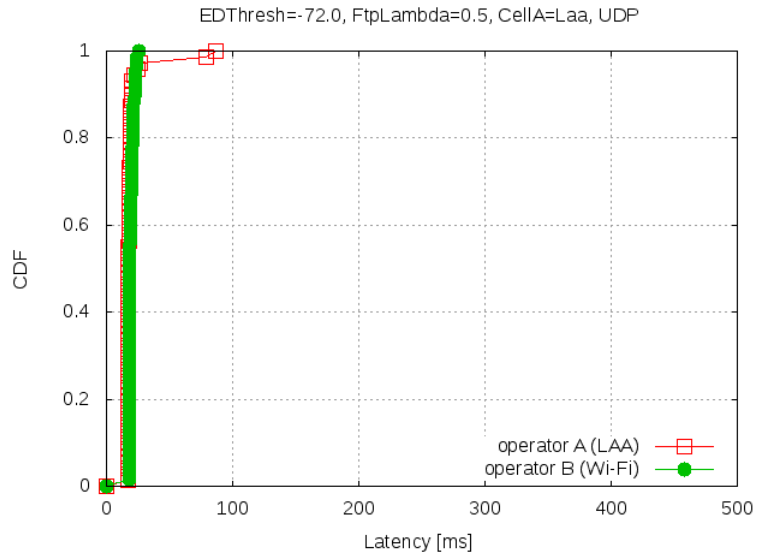

Figure 4.20: Latency of Wi-Fi/LAA for 4-SC with FTP over UDP/IP [29].

also burst traffic transfer behaviour of TCP connection have caused the reduction in the throughput of the system. In addition, the LTE system compared to the Wi-Fi system, has large latency. The RTT (Round Trip Time) in LTE changes between 15-35ms depending on the delay in scheduling and transferring the TCP ACK upstream on a licensed carrier. Therefore, the we experience high delay, and this is due to the need to transfer buffer status reports upstream, receive an uplink downlink control information (DCI) message on the downlink, and then scheduling the ACK for transmission on a next subframe. All of these parameters cause high latency for LTE system.

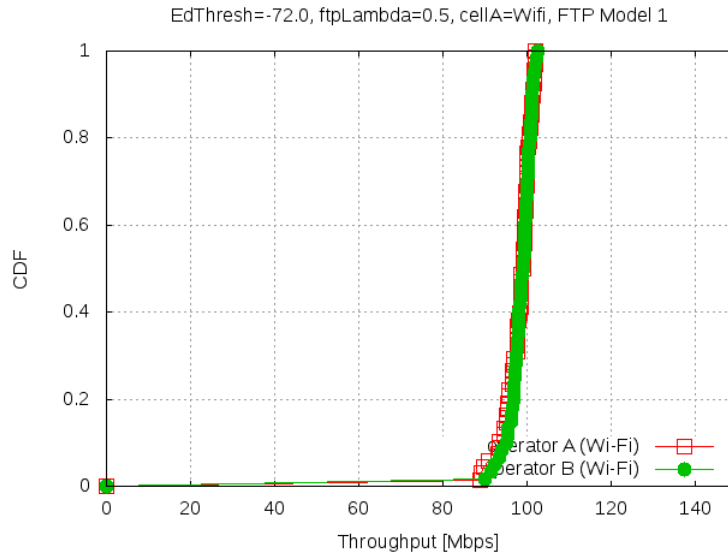

Figure 4.21: Throughput of Wi-Fi/Wi-Fi for 4-SC with FTP over TCP/IP [29].

There are two main differences, while we compare the throughput results of UDP-based file transfer application with the throughput results obtained by TCP-based file transfer application. The first one is that the LAA throughput in TCP-based application is lower than the same scenario in UDP-based application. As we mentioned above, this is because LTE system has high latency due to the need to send buffer status reports upstream, waiting to receive an uplink control message on the downlink, and scheduling the ACK on the next subframe. The second difference is that the throughput of the non-replaced Wi-Fi network (Wi-Fi/Wi-Fi) is degraded in compare to its same scenario in UDP-based application. This throughput reduction is because of the increase in the channel occupancy time that

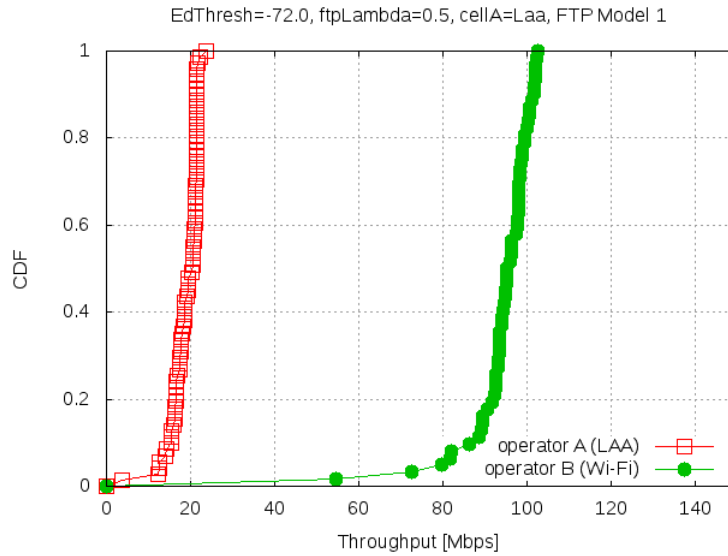

Figure 4.22: Throughput of Wi-Fi/LAA for 4-SC with FTP over TCP/IP [29].

LAA causes when TCP connection is used. This is due to the fact that, when data arrives at the LAA device, since TCP connection is used, the data is not bursty enough to be packed in a subframe efficiently. High channel occupancy time in LAA causes reduction in the Wi-Fi/Wi-Fi throughput, while using TCP/IP.

Latency evaluation of Wi-Fi/Wi-Fi coexistence scenario for 4-SC and Wi-Fi/LAA coexistence scenario for 4-SC, while using TCP/IP, are plotted in Figure 4.23 and Figure 4.24. As illustrated, the average flow latency of Wi-Fi ranges up to 5ms, while the average flow latency of LAA is around 10-20ms, although there is a few outlier values that range up to 25ms. Therefore, Wi-Fi/Wi-Fi coexistence scenario has better throughput and less latency in compare to Wi-Fi/LAA coexistence sce-

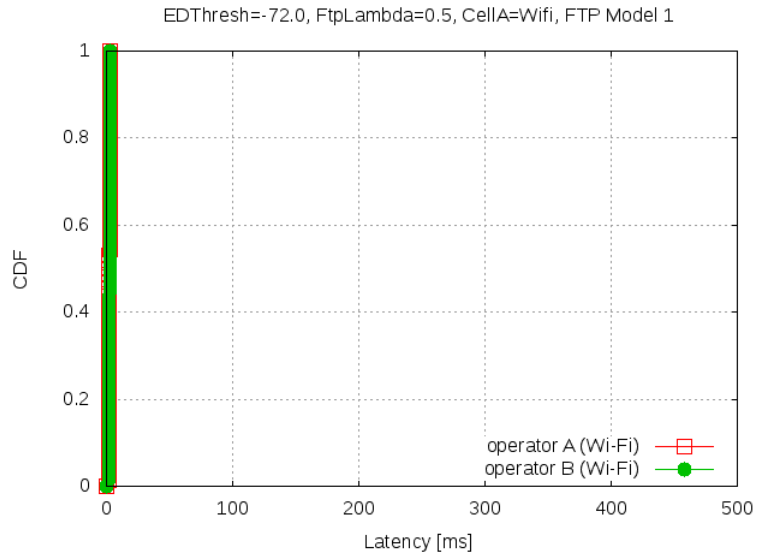

Figure 4.23: Latency of Wi-Fi/Wi-Fi for 4-SC with FTP over TCP/IP [29].

nario while TCP/IP connection is used.

In addition, it is worth mentioning the probability that the throughput is at least the given value for UDP and TCP based traffics. Figure 4.25, Figure 4.26, Figure 4.27, and Figure 4.28 show the probability that a given throughput is achieved. It is an achievability curve for UDP and TCP traffic models.

4.5.3.3 Radio Environment Map of 4-SC Indoor Scenario

In this section, Radio Environment Map (REM) of 4-SC indoor scenario is plotted for Wi-Fi/LAA, and LAA/LAA coexistence scenarios. As defined in Chapter 3, REM is a uniform two dimensional grid of values that illustrate the SINR (Signal-to-

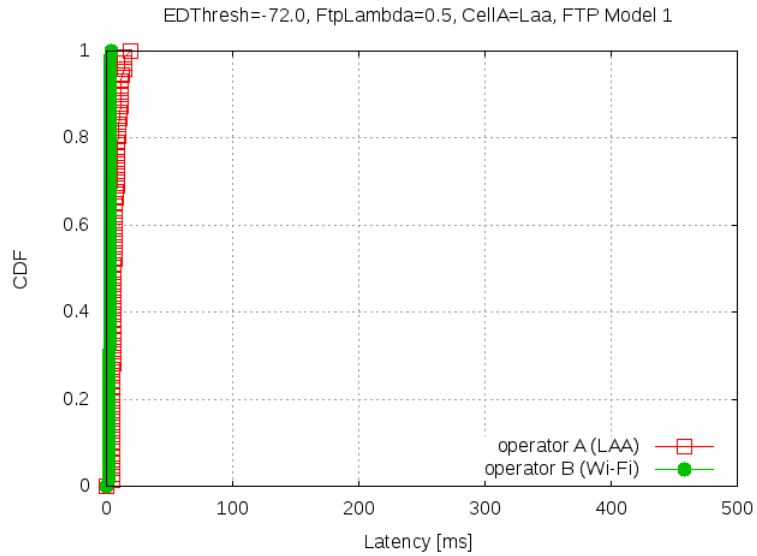

Figure 4.24: Latency of Wi-Fi/LAA for 4-SC with FTP over TCP/IP [29].

Interference-and-Noise) in the downlink with respect to eNB which has the strongest signal at each point.

REM for Wi-Fi/LAA and LAA/LAA coexistence scenarios are plotted in Figure 4.29, and Figure 4.30, using a gnuplot script. In Figure 4.29, and Figure 4.30, since there are 4 eNBs, we will see four different SINR in the downlink with respect to different strongest eNBs. As it is clear, in Figure 4.29, we will experience more stronger signals at each eNB than Figure 4.30, where both operators are serving LAA on all the 4 eNBs. It is worth mentioning that, eNBs do not directly interfere with each other, since they use LBT coexistence mechanism which transmits when the medium is free, and NS-3 takes this coexistence mechanism into account.

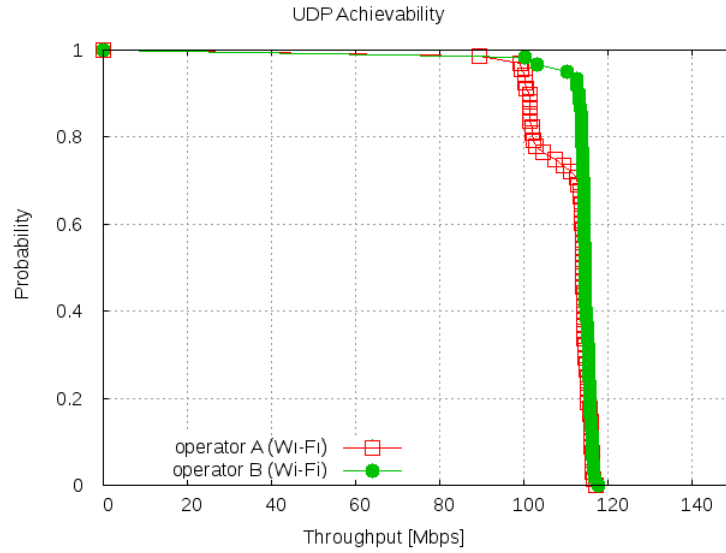

Figure 4.25: Achievable throughput of Wi-Fi/Wi-Fi for 4-SC with FTP over UDP/IP [29].

4.6 Summary

In this chapter, we have used LBT channel access scheme for our coexistence simulation scenarios. Two different scenarios have been run to get the performance of the system for 2-SC and 4-SC coexistence scenarios. As simulation results proved, using LBT for coexistence scenarios has better throughput than duty cycle. By evaluating the throughput of two scenarios, the following results have been concluded:

1. In 2-SC coexistence scenario, using LBT in a congested area, LAA provides

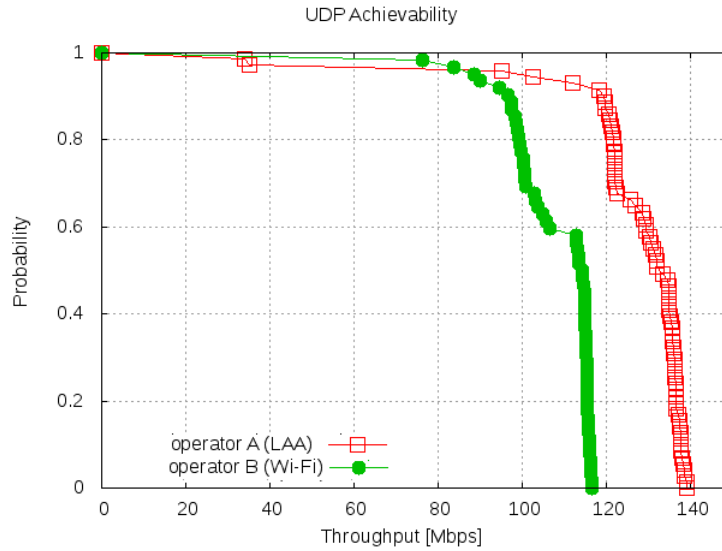

Figure 4.26: Achievable throughput of Wi-Fi/LAA for 4-SC with FTP over UDP/IP [29].

customers with the best experience with high throughput.

2. In 4-SC coexistence scenario, using LBT and UDP-based file transfer application, customers experience the best throughput in the LAA network, compared to a Wi-Fi network. It is also proved that UDP-based application has better performance than TCP-based application, since LTE systems have high latency in TCP-based application due to the time wasted to upstream the buffer status reports, and to get the uplink control messages in the downlink. Wi-Fi network in TCP-based application experiences low throughput, because of the high channel occupancy time caused by LAA. REM for

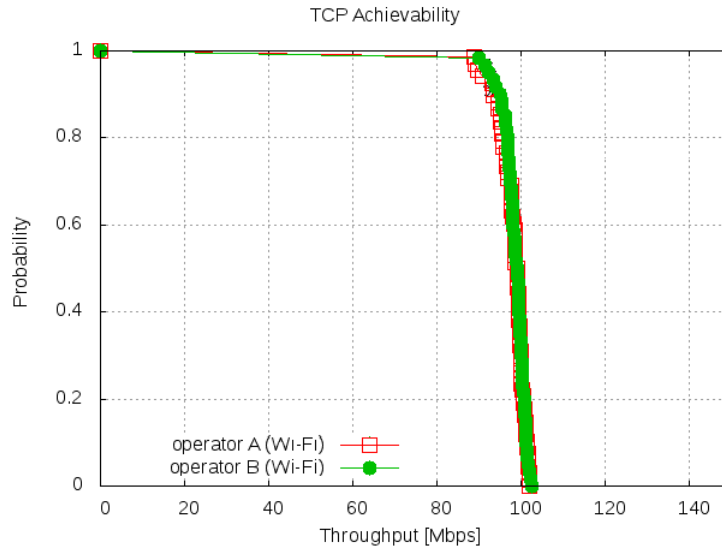

Figure 4.27: Achievable throughput of Wi-Fi/Wi-Fi for 4-SC with FTP over TCP/IP [29].

Wi-Fi/LAA, and LAA/LAA coexistence scenarios are also plotted for 4-SC indoor scenario.

In general, it is concluded that LBT provides customers with better LAA experience in the unlicensed carrier.

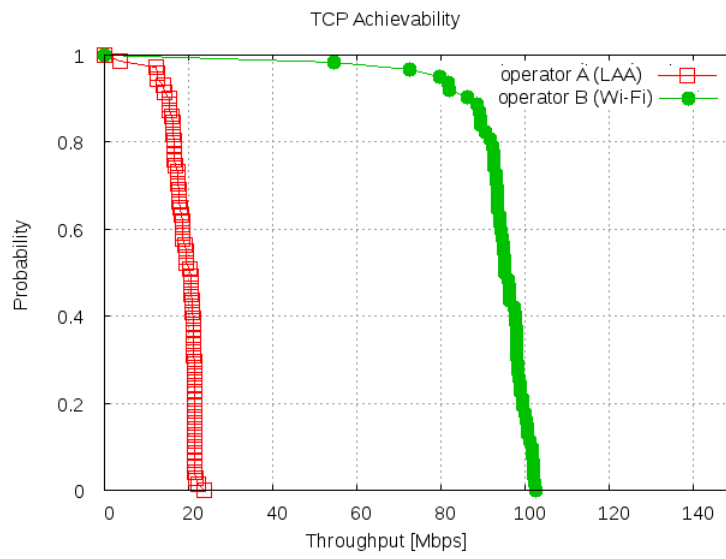

Figure 4.28: Achievable throughput of Wi-Fi/LAA for 4-SC with FTP over TCP/IP [29].

Table 4.1: NS-3 parameters for 4-SC indoor scenario

Parameters	Default settings	Description
ftpLambda	0.5	Packet arrival rate
cellConfigA	Laa/Wifi	Cell A type
cellConfigB	Laa/Wifi	Cell B type
ChannelAccessManager	Lbt	Channel access type
Intra-cell distance	10m	intra-cell separation
Inter-cell distance	10m	inter-cell separation
UDP packet size	1024bytes	UDP application packet size
Number of carriers	4	Four carriers per operator
Number of UEs	5	Five UEs per carrier per operator
cwUpdateRule	nacks80	Rule to update CW of LAA
wifiStandard	80211nFull	Wi-Fi standard type
Transport protocol	UDP	Transport type

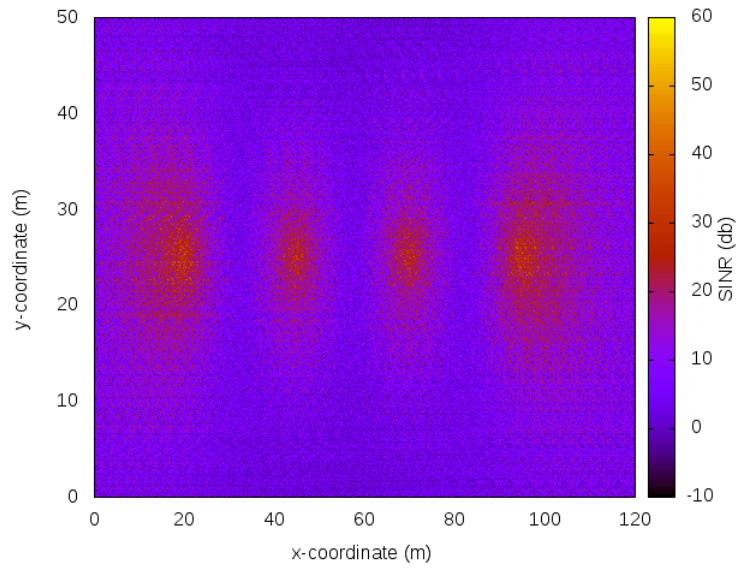

Figure 4.29: Wi-Fi/LAA radio environment map.

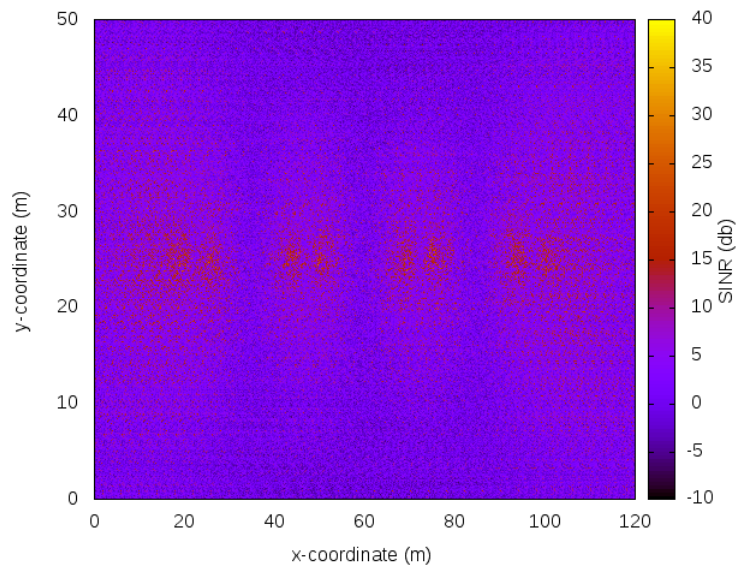

Figure 4.30: LAA/LAA radio environment map.

5 Licensed Assisted Access (LAA) Uplink (UL) and Supplementary Downlink (SDL) Coexistence with Listen-Before-Talk (LBT)

As we mentioned in chapter 2, TDD and FDD both can be used in unlicensed spectrum from the view of aggregation. As we described in the previous chapters, the aggregation concept makes the most of the radio frequency carriers which are combined together to increase the data rates, and enhance the user experience. Based on LTE Advanced concepts in the unlicensed spectrum, the first option for FDD operators is to use Supplemental Downlink (SDL), where we only aggregate downlink in unlicensed spectrum to boost the downlink only. This option for FDD operators does not enhance the uplink. On the other hand, the main option for TDD operators is to use TDD to aggregate unlicensed and licensed spectrum. This option boosts both the uplink and downlink throughputs.

Since our simulation is based on FDD, in this chapter, we evaluate uplink

throughput in the licensed spectrum, while coexisting with downlink transmissions both in licensed and unlicensed spectrum. To derive this simulation we will first take a look at 3GPP coexistence results for LAA with downlink and uplink transmissions, and the adjacent channel interference modelling used to decrease the interference and increase the RF performance. Finally we will demonstrate our simulation scenarios and results.

The rest of this chapter is organized as follows. We will explain 3GPP coexistence results for LAA with downlink and uplink transmissions in section 5.1, using the different channel access schemes described in the previous chapter. Section 5.2 covers the 3GPP adjacent channel interference model, used to increase the RF performance. We will then present our simulation scenarios and results in section 5.3, based on one of the 3GPP LBT design, mentioned in the previous chapter.

5.1 Downlink (DL) and Uplink (UL) Licensed Assisted Access (LAA) Coexisting with Wi-Fi

In this section, we describe the downlink and uplink procedure of LAA, and then based on different channel access models described in the previous chapter, we will take a look at the 3GPP results for downlink-only LAA coexisting with downlink-only Wi-Fi in section 5.1.1, then in section 5.1.2 downlink-only LAA transmissions

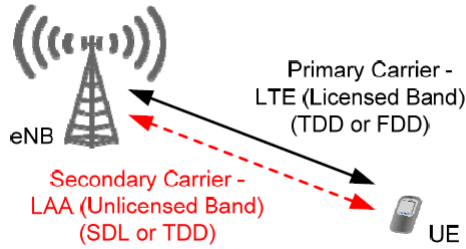

Figure 5.1: LAA using carrier aggregation [31].

coexisting with downlink and uplink Wi-Fi transmissions will be defined. Finally, in section 5.1.3, coexistence results will be observed for downlink and uplink transmissions for both LAA and Wi-Fi.

As we previously mentioned, LAA can be used downlink-only as a Supplementary Downlink (SDL) data channel, or downlink and uplink as a TDD data channel. As illustrated in Figure 5.1, a Primary Cell (PCell) is used in the licensed band and one or more Secondary Cells (SCells) are used in the unlicensed band, based on [31].

According to [31], a UE is configured to access a PCell in the licensed band and one or more SCells in the unlicensed band. PCell is used as an anchor, and a UE can not connect to unlicensed band directly. In other word, a UE has access to the SCells on unlicensed bands by the means of the PCell on the licensed band.

As we described in the previous chapter, LBT scheme allows the coexistence scenarios with other technologies such as Wi-Fi. Referring to [31], the downlink

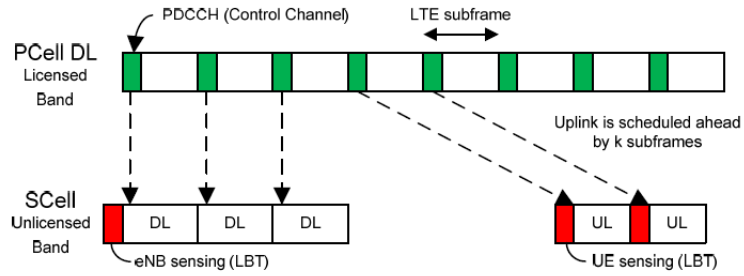

Figure 5.2: LAA using LBT [31].

procedure is as follows. First, the eNB will sense the channel, and if the channel is available, the eNB will schedule a UE for data transmission based on the fair scheduling metrics. As [31] illustrated in Figure 5.2, scheduling may be sent on the SCell or cross-carrier scheduling may be used.

When the unlicensed band is used for both downlink and uplink, the uplink procedure is as follows. Data transmission must be scheduled several subframes ahead of time by the eNB. Therefore, it is not possible for eNB to sense the channel, and the UE must sense the channel to verify if it is free, before data transmission in the designated subframe. If the channel is busy, the eNB will reschedule this transmission using either the primary or secondary carrier.

As we mentioned in the previous chapter, in the above mechanism, the carrier sensing operation can be different from that of Wi-Fi. As we described, the random backoff may be different, such as EU LBE LBT or completely absent. In the downlink, there is no need for the eNB to sense the channel, when transmitting

multiple subframes successively.

In our simulation by NS-3, we simulated downlink-only LAA as supplemental downlink (SDL), since there is more traffic in the downlink than the uplink. We will evaluate the uplink throughput in the licensed band in our simulation at the end of this chapter. In our simulation, we used a simple CCA mechanism to detect the energy level during sensing. The eNB is allowed to transmit (channel is free) when the energy level is below a threshold (laaEdThreshold is -72dBm). In case of a busy channel, the eNB keeps on sensing the channel until it is free, then selects a random backoff amount in number of subframes. The eNB is allowed to do data transmission when the channel is free for the specific duration.

In the next section, we will provide 3GPP results for downlink-only LAA coexisting with downlink-only Wi-Fi in the unlicensed band using different channel access schemes, mentioned in the previous chapter.

5.1.1 Downlink (DL) Licensed Assisted Access (LAA) Coexisting with Downlink (DL) Wi-Fi

Referring to [28], the results for an indoor deployment with one shared unlicensed carrier and FTP traffic are as follows.

- All metrics were improved for the non-replaced Wi-Fi operator when the other coexisting Wi-Fi operator was replaced by LAA with a category 2 LBT

scheme. As mentioned in chapter 4, category 2 LBT scheme is an LBT coexistence mechanism without random backoff.

- When the other coexisting Wi-Fi operator was replaced by LAA with a category 3 LBT scheme, all the metrics were improved for the non-replaced Wi-Fi operator. The same results were obtained for the additional case where RTS/CTS was enabled in the non-replaced Wi-Fi network. It is worth reminding that, category 3 LBT scheme is an LBT coexistence mechanism with random backoff with a contention window of fixed size. EU LBE LBT is a category 3 LBT scheme.
- There was a degradation in all the metrics for the non-replaced Wi-Fi when TxOP of 4ms was used, however there was improvement in all the metrics for the non-replaced Wi-Fi when TxOP of 13ms was used. It is worth mentioning that, TxOP is a transmission opportunity for LAA nodes. In our simulation a default TxOP of 8ms is used.
- A majority of the evaluations showed that two LAA networks have similar performance by some means.

5.1.2 Downlink (DL) Licensed Assisted Access (LAA) Coexisting with Downlink (DL) and Uplink (UL) Wi-Fi

According to [28], while using an indoor deployment with one shared unlicensed carrier and FTP traffic, the following results are obtained.

- A LAA with a category 2 LBT scheme showed improvement in all the performance metrics for the non-replaced Wi-Fi, based on one source. As mentioned in chapter 4, category 2 LBT scheme is an LBT coexistence mechanism without random backoff.
- A majority of sources showed improvement in all the performance metrics for the non-replaced Wi-Fi for a LAA with at least one version of a category 3 LBT scheme without the use of the licensed carrier. It is worth remembering that, category 3 LBT scheme is an LBT coexistence mechanism with random backoff with a contention window of fixed size. EU LBE LBT is a category 3 LBT scheme.
- Based on six sources, all the performance metrics improved when one of the coexisting operators was replaced by LAA. According to one of the sources, there is improvement in all the performance metrics for the additional case where RTS/CTS was enabled in the non-replaced Wi-Fi network.
- Enabling RTS/CTS for the coexisting Wi-Fi operator at high loads in the

non-replaced Wi-Fi network, causes UL throughput degradation, based on two sources. The other sources showed a DL throughput degradation where RTS/CTS was enabled for the coexisting Wi-Fi operator at medium load in the non-replaced Wi-Fi network.

- At least one LBT design for LAA does not have impact on Wi-Fi more than another Wi-Fi network based on a majority sources, since it provides the same traffic to the same users.
- When using a category 1 LBT scheme, where there is no coexistence mechanism, does have impact on Wi-Fi in at least some of the performance parameters.
- A LAA network using a category 2 DL LBT scheme can provide service to the users without impacting Wi-Fi more than an equivalent Wi-Fi network. As mentioned in chapter 4, category 2 LBT scheme is an LBT coexistence mechanism without random backoff.
- A LAA network using a category 3 DL LBT scheme with some modifications such as changing the defer period to the minimum, can provide users with services which do not impact Wi-Fi more than another Wi-Fi network. It is worth remembering that, category 3 LBT scheme is an LBT coexistence mechanism with random backoff with a contention window of fixed size. EU

LBE LBT is a category 3 LBT scheme.

- A LAA network using a category 4 DL LBT scheme with some modifications including at least defer periods and exponential contention windows, can provide service to the users without impacting Wi-Fi more than an equivalent Wi-Fi network. Category 4 LBT scheme, as described in chapter 4, is an LBT coexistence mechanism with random backoff with a contention window of variable size. Wi-Fi LBT is a category 4 LBT scheme.

5.1.3 Downlink (DL) and Uplink (UL) Licensed Assisted Access (LAA) Coexisting with Downlink (DL) and Uplink (UL) Wi-Fi

Based on [28], for an indoor deployment with one shared unlicensed carrier and FTP traffic, results are as follows.

- A LAA with a category 3 LBT scheme on the DL and UL with the UL being scheduled using self-scheduling showed improvement in all the measured performance metrics for the non-replaced Wi-Fi network.
- A LAA with a category 3 LBT scheme on the DL with a category 2 and category 3 LBT scheme on the UL, showed improvement for both the LBT combinations. While LAA using a category 3 on the UL, better performance metrics were observed.

- While RTS/CTS was enabled for Wi-Fi network, improvement in all the performance metrics for the non-replaced Wi-Fi were observed.
- A LAA with a category 4 LBT on the UL, with some modifications including self-scheduling and shortened contention windows for faster UL channel access, showed improvement in all the performance metrics for non-replaced Wi-Fi. Category 4 LBT scheme, as described in chapter 4, is an LBT coexistence mechanism with random backoff with a contention window of variable size. Wi-Fi LBT is a category 4 LBT scheme.
- Combinations of LAA DL and UL LBT schemes do not impact Wi-Fi more than another Wi-Fi network in measured performance metrics, since they offer the same traffic to the same users. Category 3 and 4 were tested for the DL and categories 1 to 4 were tested for the UL.

5.2 Adjacent Channel Interference (ACI)

In this section, we evaluate the impact of Adjacent Channel Interference (ACI) on system performance based on [28]. We consider a scenario with the aggressor system that uses the channel frequently, and the victim system that rarely has a chance to get the channel with different RF characteristics use ACI. According to ACI point of view, a system with better RF, creates lower interference. Therefore,

first we describe the ACIR modeling in section 5.2.1 , and then we evaluate different aggressor and victim scenarios using ACI. It is also worth mentioning that, ACI uses only unlicensed band.

5.2.1 Adjacent Channel Interference Ratio

According to [28], ACIR can be defined as a function of Adjacent Channel Leakage Ratio (ACLR) and Adjacent Channel Selectivity (ACS) as follows:

$$ACIR \approx \frac{1}{\frac{1}{ACLR} + \frac{1}{ACS}} \quad (5.1)$$

Adjacent Channel Leakage Ratio (ACLR) is defined as the ratio of transmitted power to the power in the adjacent channel, and Adjacent Channel Selectivity (ACS) is a receiver's ability to receive a signal at its assigned channel frequency in the presence of a strong signal in the adjacent channel. ACLR and ACS are calculated based on Adjacent Channel Rejection (ACR). Adjacent Channel Rejection is defined as a function of the MCS as reported in [28]. Referring to [28], by considering a range from 22dB to 29dB for ACS, we will be able to cover different Wi-Fi and LAA scenarios and their ACIR comparison. Table 5.1 summarizes the ACIR values used to model both Wi-Fi and LAA.

Having calculated ACIR for the scenarios where the Wi-Fi AP/STA is a victim and the aggressor is LAA BS, LAA UE, or another Wi-Fi AP/STA, the results are as follows.

Study Case	Wi-Fi ACS (dB)	Aggressor ACLR (dBc)	ACIR (dB)
LAA node to Wi-Fi AP/STAs	22	45	21.98
	25		24.96
	29		28.89
LAA UE to Wi-Fi AP/STAs	22	30	21.36
	25		23.81
	29		26.46
Wifi AP/STAs to Wi-Fi AP/STAs	22	26.35	20.64
	25		22.61
	29		24.47

Table 5.1: ACIR for different Wi-Fi and LAA scenarios [28].

As illustrated in table 5.1 when LAA is the aggressor, the ACIR value is bigger compared to the case when Wi-Fi is the aggressor. This is because of the better ACLR available for LAA. Since LAA UEs and BSs have better ACLR compared to Wi-Fi STAs/APs, LAA UEs and BSs cause lower interference leakage into the adjacent victim channel, compared to Wi-Fi AP/STA. Finally, since LAA has better RF performance, it creates lower Adjacent Channel Interference compared to Wi-Fi AP/STA. In indoor scenarios, like Wi-Fi/Wi-Fi, Wi-Fi/LAA, the latter has bigger ACIR, better ACLR, and lower ACI in compared to Wi-Fi/Wi-Fi case.

In conclusion, the LAA and Wi-Fi can coexist in adjacent channels. LAA creates lower adjacent channel interference to a Wi-Fi system compared to another Wi-Fi system. It means that, LAA is a better neighbour to a Wi-Fi system compared to another Wi-Fi system in terms of adjacent channel coexistence with Wi-Fi system.

At the end, it is worth noticing that adjacent channel interference analysis for

LAA/LAA scenario has the following results based on [28]. Adjacent interference coming from other LAA nodes or other nodes with different technologies and different ACLR operating in the same 5GHz band affect LAA performance. Therefore, there is no guarantee that ACI will be low at LAA nodes. This is because of the presence of other technologies with different ACLR in the same 5GHz as LAA. In conclusion, for the LAA/LAA scenario operating in 5GHz band, it is difficult to ensure a low adjacent channel interference in case where other technologies than LAA are contributing in the same 5GHz band as LAA.

5.3 Experimental Results

In this section, simulation results will be described. This section is organized as follows. Section 5.3.1 will demonstrate our simulation scenario and methodology. Coexistence results will be plotted in section 5.3.2.

5.3.1 Scenario and Methodology

As we described in the previous chapters, there are two different scenarios, indoor, and outdoor. Since the indoor scenario has more importance than the outdoor scenario, we consider the indoor scenario. The 2-SC indoor scenario was covered in detail in chapter 3, and the 4-SC scenario was covered in detail as well in the previous chapter. Table 3.2 in chapter 3, and table 4.1 in chapter 4, list NS-3

parameters for the 2-SC and 4-SC indoor scenarios, respectively. To evaluate the UL performance, we concentrate on the 2-SC scenario, and we calculate the UL throughput in the licensed band. Table 5.2 lists NS-3 parameters for the 2-SC indoor scenario with uplink in the licensed band. First we consider the LAA/LAA coexistence scenario to evaluate the UL performance of the system, and finally we will cover the Wi-Fi/LAA coexistence scenario to assess the UL performance. As we mentioned performance metrics in the previous chapters, in section 5.3.1.1, we will cover some of the performance metrics used in our simulation.

5.3.1.1 Performance Metrics

In this section, we cover some of the performance metrics used in our simulation.

The performance metrics are as follows.

- User throughput: the received amount of data on a flow divided by the time difference between the last and first packet received.

$$User\ throughput = \frac{\textit{The received amount of data}}{\textit{Time difference between the last and first packet received}}$$

- TxOffered : the amount of data sent on a flow divided by scheduled duration of data transfer.

5.3.2 Coexistence Results

In this section, first we consider the LAA/LAA coexistence scenario to evaluate UL performance in the licensed band, while the DL is on both the licensed and unlicensed bands, and finally, UL performance evaluation of Wi-Fi/LAA scenario will be plotted. We consider single carrier case where one shared unlicensed band is used, since single carrier scenario makes the most contention to access the channel between the devices. Therefore, in the following section, we will plot the result of indoor high loaded single carrier scenario. Section 5.3.2.1 covers the evaluation results for 2-SC indoor scenario in the congested area, where there are at least ten users.

5.3.2.1 2-SC Simulation Results

As we previously mentioned, first of all, we will consider LAA/LAA coexistence scenario, while the downlink is on both the licensed and unlicensed bands, and the uplink is on the licensed band. Then, having the same configuration, a Wi-Fi/LAA scenario will be plotted to show uplink throughput assessment. Finally, downlink and uplink overall throughput evaluation of both scenarios are also plotted. It is worth mentioning that the channel access scheme is LBT, like the previous chapter.

To have a better idea of UL throughput, Figure 5.3 demonstrates UL throughput

compared to DL throughput, while LAA/LAA scenario is used for 2-SC in dense area.

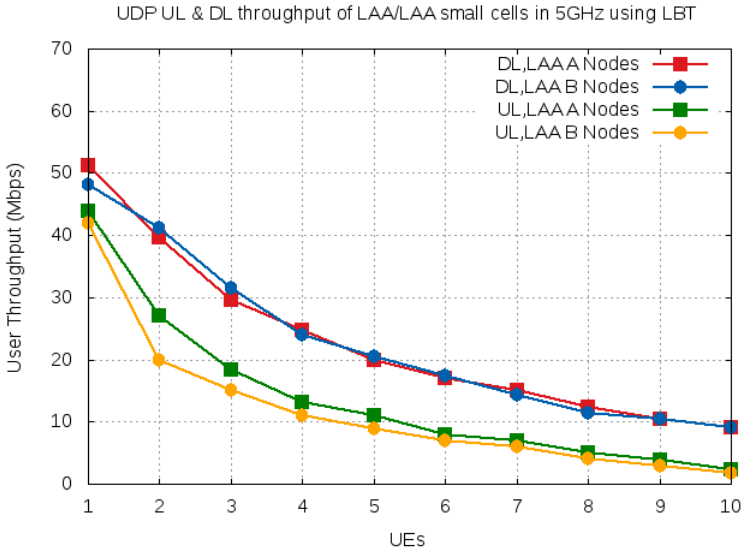

Figure 5.3: DL and UL throughput evaluation of LAA/LAA for 2-SC in dense area.

As Figure 5.3 illustrates, UL throughput is less than DL throughput. The reason is that the eNB always schedules data transmission some subframes ahead of time. In the UL, since the eNB does not know if the channel is free, therefore, it is the UE’s responsibility to sense the channel before data transmission. If the channel is busy, the UE will not do the transmission. The eNB can then reschedule this transmission again. On one hand, this rescheduling can cause a high delay, on the other hand, the other delay when TCP transport is used, is due to the TCP ACK upstream on the licensed band. This delay can be pretty high since there is

a need to send buffer status reports upstream, receive an uplink DCI (Downlink Control Information) message on the downlink, and then scheduling the ACK for transmission on a future subframe. All these delays can cause degradation on the UL throughput. It is worth mentioning that the UE reports Received Signal Strength Indicator (RSSI) measurements to the eNB. This RSSI measurements report sent to eNB by UE is beneficial for the purpose of detecting hidden node in the channel selection. RSSI is a measurement of the power present in a received radio signal. RSSI is an indication of the power level being received by the receive radio after the antenna and possible cable loss. Therefore, the higher the RSSI number, the stronger the signal.

Downlink and uplink overall user throughput evaluation of LAA/LAA for 2-SC in high-traffic area are plotted in Figure 5.4. It is clear that the downlink has better overall throughput compared to the uplink.

As we previously mentioned, in the second part of our experiment, the UL performance evaluation of Wi-Fi/LAA scenario is performed. To compare the DL throughput evaluation of Wi-Fi/LAA scenario for 2-SC in a high-traffic area with the UL throughput evaluation of Wi-Fi/LAA scenario for 2-SC, Figure 5.5 depicts this comparison. The UL throughput of LAA nodes in licensed band in Wi-Fi/LAA scenario is lower than the DL throughput of both Wi-Fi nodes and LAA nodes. As we previously mentioned, since eNB in the UL, the UE senses the channel before

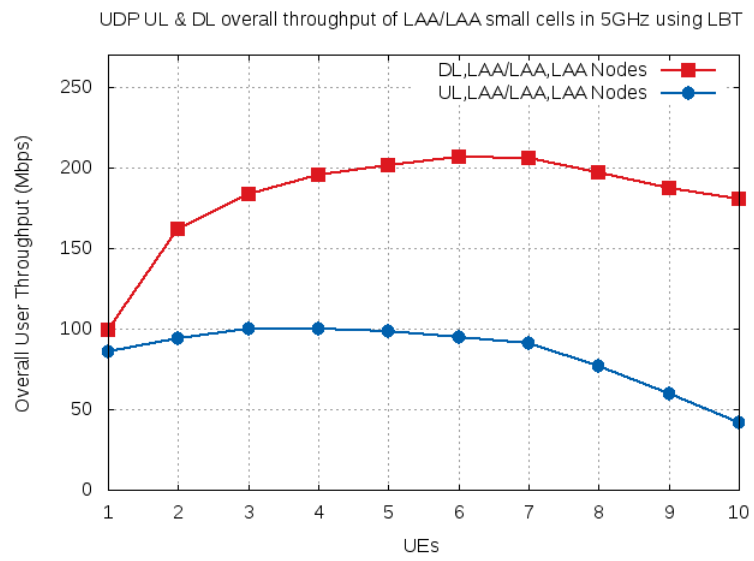

Figure 5.4: DL and UL overall throughput evaluation of LAA/LAA for 2-SC in dense area.

data transmission. If the channel is idle, the UE will do the transmission, and if the channel is busy, the UE will not do the transmission, and the eNB can reschedule this transmission afterwards. The process of rescheduling can cause a high delay for UL. One of the other factors that causes delay, is when TCP transport is used, since TCP ACK should go upstream on the licensed band. This delay is also high.

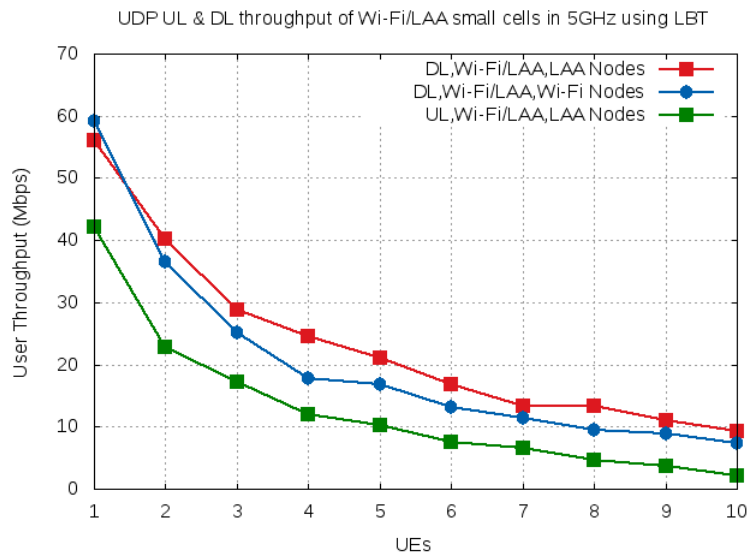

Figure 5.5: DL and UL throughput evaluation of Wi-Fi/LAA for 2-SC in dense area.

Downlink and uplink overall user throughput evaluation of Wi-Fi/LAA for 2-SC in high-traffic area is plotted in Figure 5.6. It is obvious that there is a big difference between the overall throughput evaluation of Wi-Fi/LAA scenario for the 2-SC in high-traffic area in uplink and downlink.

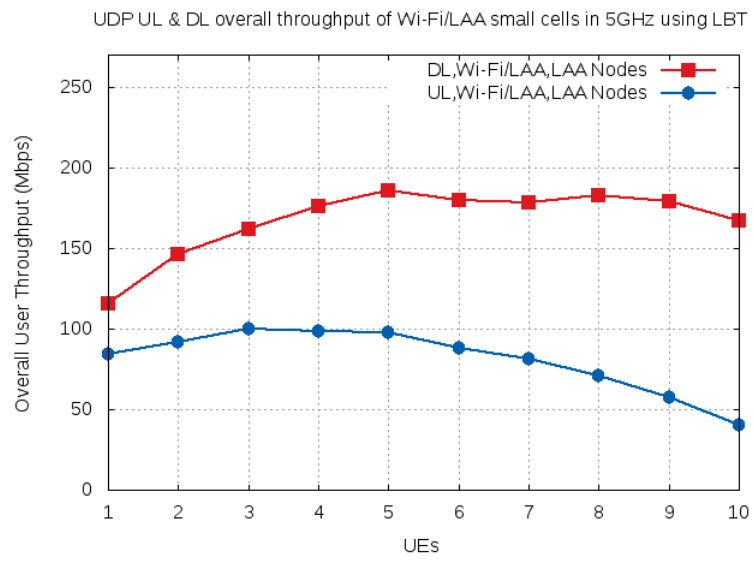

Figure 5.6: DL and UL overall throughput evaluation of Wi-Fi/LAA for 2-SC in dense area.

5.4 Summary

In this chapter, we first considered 3GPP coexistence results for LAA with downlink-only transmissions in the unlicensed band, including downlink-only LAA coexisting with downlink-only Wi-Fi, and downlink-only LAA coexisting with downlink and uplink Wi-Fi, and then results for LAA with downlink and uplink transmissions in the unlicensed band, including downlink and uplink LAA coexisting with downlink and uplink Wi-Fi in the unlicensed band, was described. There exists at least one LBT scheme for LAA that does not impact Wi-Fi more than another Wi-Fi network. It was concluded that when a suitable channel access scheme is used, it is possible for LAA to coexist with Wi-Fi or another LAA fairly.

Based on experimental results, it was proved that the LBT channel access framework was the best choice to adopt for LAA. This channel access framework consisted of a category 4 LBT scheme, including random backoff and variable contention windows, at least for the downlink data transmissions. It was concluded that some important parameters of the LBT scheme, like contention windows and defer periods, must be configurable with limits to make it possible to have fair coexistence with other technologies operating in unlicensed spectrum. It was concluded that in LAA systems, uplink LBT is supported at the UE, since the eNB does not know if the channel is free, and it is up to the UE to sense the channel. We were described that

the UE's uplink transmissions are controlled by the eNB in LAA SC, and therefore there is a slight difference in the uplink channel access scheme and the downlink channel access scheme. As we mentioned, the UE RSSI measurements reported to the eNB was beneficial since hidden node can be detected in the channel selection.

Moreover, based on 3GPP ACI results, it is concluded that LAA and Wi-Fi can coexist in adjacent channels, and LAA causes less adjacent channel interference to Wi-Fi system compared to another Wi-Fi system. Finally, our simulation scenario accurately proved that the UL throughput in the licensed band is less than the DL throughput in the licensed and unlicensed bands in the LAA/LAA coexistence 2-SC indoor scenario in the high loaded area. This was due to rescheduling delay caused by the eNB, and TCP ACK upstream delay. This is particularly illustrated through results for uplink throughput assessment in the licensed band for LAA/LAA with uplink transmissions on the licensed band, and downlink transmissions on both licensed and unlicensed bands. The same results are also driven by LAA nodes in the Wi-Fi/LAA scenario, and overall network throughput, which precisely demonstrated the accuracy of our outcome.

Table 5.2: NS-3 parameters for 2-SC indoor scenario with uplink

Parameters	Default settings	Description
ftpLambda	0.5	Packet arrival rate
cellConfigA	Laa	Cell A type
cellConfigB	Laa/Wifi	Cell B type
ChannelAccessManager	Lbt	Channel access type
Intra-cell distance	10m	intra-cell separation
Inter-cell distance	10m	inter-cell separation
UDP packet size	1024bytes	UDP application packet size
Number of carriers	1	One carrier per operator
cwUpdateRule	nacks80	Rule to update CW of LAA
wifiStandard	80211nFull	Wi-Fi standard type
Uplink frequency band	1	Uplink licensed frequency band
Transport protocol	UDP	Transport type

6 Conclusion and Future Work

This thesis presented the results of a study on the operation of LTE in unlicensed spectrum as a secondary cell (so-called SDL) through simulations. SDL is the main option for FDD operators to aggregate downlink in unlicensed spectrum, and boost the downlink performance. In chapter 2, it has been described that the use of LTE in unlicensed spectrum can be a beneficial opportunity by operators to provide the users with better experience, while the core of the service, remains anchored to the licensed spectrum, as the experimental results have been proved. In chapter 2, some of the fundamental concepts of LTE in unlicensed spectrum, as well as vital modifications for LTE to operate in unlicensed spectrum as a secondary cell through carrier aggregation were described. Having LTE in unlicensed spectrum caused design targets and deployment scenarios of the coexistence between LTE-U (LAA) and other networks such as Wi-Fi in unlicensed spectrum to be addressed through two different mechanisms, namely duty cycle (CSAT), and LBT. UL performance in the licensed spectrum was evaluated in chapter 5 through simulations.

The coexistence evaluation performed during the study were covered in chapter 3, and chapter 4. The first coexistence mechanism, CSAT (so-called duty cycle), was described in detail in chapter 3. The basic concepts and simulation results for different scenarios using this mechanism were plotted. In chapter 4, LBT coexistence mechanism concepts, and differences with other technologies operating in unlicensed spectrum like the one used in Wi-Fi (Wi-Fi LBT), were covered. LTE modifications for LBT, 3GPP LBT design, and different scenarios using LBT were covered in chapter 4, and simulation results were plotted.

The channel access scheme that were evaluated for LAA with downlink-only and for LAA with downlink and uplink transmissions are mentioned in chapter 5. Based on the majority of sources, there is at least one LBT scheme for LAA, which does not have impact on Wi-Fi more than another Wi-Fi network. When a suitable channel access scheme was used, it is feasible for LAA to obtain fair coexistence with Wi-Fi, and for LAA to coexist with itself, as different simulation scenarios and their results proved.

Based on experimental results, it was proved that the channel access framework defined in chapter 4 (LBT) can be adopted for LAA. This channel access framework consisted of a category 4 LBT scheme including random backoff and variable contention windows at least for the downlink data transmissions. It was concluded that some important parameters of the LBT scheme, like contention windows and

defer periods, must be configurable with limits to make it possible to have fair coexistence with other technologies operating in unlicensed spectrum.

In chapter 5, it was concluded that in LAA systems, uplink LBT is supported at the UE, since the eNB does not know if the channel is free, and it is up to the UE to sense the channel. We showed that the UE's uplink transmissions are controlled by the eNB in an LAA SCell, and therefore there is a slight difference in the uplink channel access scheme and the downlink channel access scheme. As we mentioned, the UE RSSI measurements report to the eNB was beneficial since hidden node can be detected in the channel selection. It was also concluded that the LAA and Wi-Fi can coexist in adjacent channels. It was proved that LAA caused less adjacent channel interference to a Wi-Fi system compared to another Wi-Fi system. In other words, LAA is a better neighbour to Wi-Fi than another Wi-Fi system in terms of adjacent channel coexistence with a Wi-Fi system.

For future work, uplink evaluation, when the unlicensed spectrum is used for both downlink and uplink can be studied. Moreover, different scenarios such as those used in congested areas can be defined using our channel access framework, and then downlink and uplink performance can be plotted.

Bibliography

- [1] Thinksmallcell, “A quick introduction to small cells and small cells backhaul,” Whitepaper at thinksmallcell.com, October, 2013.
- [2] Ruckuswireless, “LTE small-cell backhaul and GSM cellular backhaul,” Whitepaper at ruckuswireless.com, Feb. 2012.
- [3] C. Ranaweera, M. G. C. Resende, K. Reichmann, P. Lannone, P. Henry, B. Kim, P. Magill, K. N. Oikonomou, R. K. Sinha, and S. Woodward, “Design and optimization of fiber optic small cell backhaul based on an existing fiber-to-the-node residential access network,” *IEEE Communications Magazine.*, vol. 9, Sep. 2013.
- [4] D. Bladsjo, M. Hogan, and S. Ruffini, “Synchronization aspects in LTE small cells,” *IEEE Communications Magazine.*, vol. 9, Sep. 2013.
- [5] M. Coldrey, J. Berg, L. Manholm, C. Larsson, and J. Hansryd, “Non-line-of-sight small cell backhauling using microwave technology,” *IEEE Communications Magazine.*, vol. 9, Sep. 2013.
- [6] D. Bojic, E. Sasaki, N. Cvijetic, T. Wang, J. Kuno, J. Lessmann, S. Schmid, H. Ishii, and S. Nakamura, “Advanced wireless and optical technologies for small cell mobile backhaul with dynamic software-defined management,” *IEEE Communications Magazine.*, vol. 9, Sep. 2013.
- [7] F. Ponzini, L. Giorgi, A. Bianchi, and R. Sabella, “Centralized radio access networks over wavelength-division multiplexing: a plug-and-play implementation” *IEEE Communications Magazine.*, vol. 9, Sep. 2013.
- [8] W. Ni, R. P. Liu, L. B. Collings, and X. Wang, “Indoor cooperative small cells over ethernet,” *IEEE Communications Magazine.*, vol. 9, Sep. 2013.
- [9] A. Maltsev, A. Khoryaev, A. Lomayev, R. Maslennikov, C. Antonopoulos, K. Avgeropoulos, A. Alexiou, F. Boccardi, Y. Hou, and K. K. Leung, “MIMO and

- multihop cross-layer design for wireless backhaul: a testbed implementation,” *IEEE Communications Magazine.*, vol. 9, Sep. 2013.
- [10] W. Sun, O. Lee, Y. Shin, S. Kim, C. Yang, H. Kim, and S. Choi, “Wi-Fi could be much more,” *IEEE Communications Magazine.*, vol. 18, Nov. 2014.
- [11] O. Jo, W. Hong, S. T. Choi, S. Chang, C. Kweon, J. Oh, and K. Cheun, “Holistic design considerations for environmentally adaptive 60 GHz beamforming technology,” *IEEE Communications Magazine.*, vol. 18, Nov. 2014.
- [12] S. Rajagopal, “Power efficiency: the next challenge for multi-gigabit-per-second Wi-Fi,” *IEEE Communications Magazine.*, vol. 18, Nov. 2014.
- [13] R. Kudo, Y. Takatori, B. A. H. S. Abeysekera, Y. Inoue, A. Murase, A. Yamada, H. Yasuda, and Y. Okumura, “An advanced Wi-Fi data service platform coupled with a cellular network for future wireless access,” *IEEE Communications Magazine.*, vol. 18, Nov. 2014.
- [14] F. M. Abinader, E. P. L. Almeida, F. S. Chaves, A. M. Cavalcante, R. D. Vieira, R. C. D. Paiva, A. M. Sobrinho, S. Choudhury, E. Tuomaala, K. Doppler, and V. A. Sousa, “Enabling the coexistence of LTE and Wi-Fi in unlicensed bands,” *IEEE Communications Magazine.*, vol. 18, Nov. 2014.
- [15] Alcatel-Lucent, “Combine the best of Wi-Fi and LTE to enhance mobile performance and offer a consistent high-quality subscriber experience,” Whitepaper at alcatel-lucent.com, 2015.
- [16] A. M. Cavalcante et al., “Performance evaluation of LTE and Wi-Fi coexistence in unlicensed bands,” *IEEE Transactions Communications.*, vol. 54, Proc. IEEE 77th VTC 2013-Spring, Dresden, Germany, June, 2013.
- [17] T. Nihtil et al., “System performance of LTE and IEEE 802.11 coexisting on a shared frequency band,” *IEEE Wireless Communications and Networking Conf. 2013*, April, 2013.
- [18] Qualcomm Research LTE in Unlicensed Spectrum, “LTE-U/LAA, MuLTEfire and Wi-Fi; making best use of unlicensed spectrum” *Qualcomm Technologies, Inc*, vol. 1.0, Sep. 2015.
- [19] NSN Whitepaper, “Enhance mobile networks to deliver 1000 times more capacity by 2020,” vol. 1.0, Feb. 2013.
- [20] LTE-U Technical Report, “Coexistence Study for LTE-U SDL,” *LTE-U Forum*, vol. 1.0, Feb. 2015.

- [21] Signals Research Group, “ The Prospect of LTE and Wi-Fi Sharing Unlicensed Spectrum” *Signals Research Group*, vol. 1.0, Dec. 2014.
- [22] Nokia Solutions and Networks Oy, “ LTE for Unlicensed Spectrum” *Nokia Networks*, vol. 1.1, Dec. 2014.
- [23] Qualcomm Research LTE in Unlicensed Spectrum, “ Harmonious Coexistence with Wi-Fi” *Qualcomm Technologies, Inc*, vol. 1.0, June. 2014.
- [24] CableLabs Research LTE in Unlicensed Spectrum, “ Wi-Fi vs. Duty Cycled LTE: A Balancing Act ” *CableLabs Technologies, Inc*, vol. 1.1, Dec. 2014.
- [25] E. Almeida, A. M. Cavalcante, and R. C. D. Paiva, “Enabling LTE/Wi-Fi coexistence by LTE blank subframe allocation,” *IEEE ICC. on Wireless Communications Symposium.*, vol. 5, no. 7, pp. 5083–5088, Jul. 2013.
- [26] CableLabs Research LTE in Unlicensed Spectrum, “ Wi-Fi vs. EU LBT: Houston, we have a problem ” *CableLabs Technologies, Inc*, vol. 1.1, Nov. 2014.
- [27] A. Babaei, CableLabs Research LTE in Unlicensed Spectrum “Comments on LAA EVM,” *IEEE 802.19-15/0007r0*, Louisville, USA, Jan. 2015.
- [28] [TR36889] 3GPP TR 36.889, “Study on Licensed-Assisted Access to Unlicensed Spectrum,” (Release 13) TR 36.889v13.0.0 (2015-06) *3rd Generation Partnership Project*, June 2015.
- [29] T. Henderson, “LTE LBT Wi-Fi Coexistence Module,” *ns-3 project*, Feb. 2016.
- [30] [TR36814] 3GPP TR 36.814, “Technical Specification Group Radio Access Network, Evolved Universal Terrestrial Radio Access (E-UTRA), Further advancements for E-UTRA physical layer aspects,” (Release 9) TR 36.814v9.0.0 (2010-03) *3rd Generation Partnership Project*, March 2010.
- [31] R. Ratasuk, N. Mangalvedhe, and A. Ghosh, “LTE in Unlicensed Spectrum using Licensed-Assisted Access,” *IEEE Trans. Tele Commun.*, vol. 5, no. 10, Oct. 2014.
- [32] A. Mukherjee, J. Cheng, S. Falahati, and L. Falconetti, “System architecture and coexistence evaluation of licensed-assisted access LTE with IEEE 802.11,” *IEEE Trans. Tele Commun*, vol. 52, pp. 362–371, Feb. 2015.
- [33] “ns-3,” <https://www.nsnam.org/>, Retrieved December 5, 2015.