

ROLE AND REGULATION OF FRA-2 DURING SKELETAL MUSCLE  
DEVELOPMENT

NEZEKA ALLI

A DISSERTATION SUBMITTED TO  
THE FACULTY OF GRADUATE STUDIES  
IN PARTIAL FULFILLMENT OF THE REQUIREMENTS  
FOR THE DEGREE OF  
DOCTOR OF PHILOSOPHY

GRADUATE PROGRAM IN BIOLOGY  
YORK UNIVERSITY  
TORONTO, ONTARIO

JUNE 2014

© Nezeke Alli, 2014

## Abstract

Regulation of skeletal muscle development and regeneration is critical to all metazoans and also of clinical relevance as muscle wasting is manifested in a variety of disorders. The events contributing to development and regeneration of skeletal muscle are primarily controlled by members of the myogenic regulatory factors (MRF) and myocyte enhancer factor 2 (MEF2) transcription factor families. Secondary factors also exert effects on myogenesis such as the activator protein 1 (AP-1) transcription factor which has a complex role in the differentiation process. The AP-1 subunit Fra-2 has a role in skeletal muscle development and regeneration but it is less defined. Here, the role of Fra-2 in skeletal myogenesis was investigated thereby extending the study of AP-1 in muscle. It was determined that Fra-2 is regulated by the ERK 1/2 MAPK pathway via phosphorylation at S320 which is important for Fra-2 protein stability. Gain of function studies exploiting stability of Fra-2 achieved by phosphomimetic mutations impacted differentiation negatively. Conversely, loss of function using siRNAs resulted in precocious differentiation suggesting an overall inhibitory role for Fra-2 in myogenic cells. Intriguingly, it was observed that AP-1 is differentially expressed in a differentiated culture of C2C12 myogenic cells in that Fra-2 expression is restricted to mononucleated reserve cells and not in the differentiated myotubes. Furthermore, it was determined that Fra-2 is expressed in Pax7 positive satellite cells in a single muscle fibre culture model and that it binds to the promoter of the *mustn1* gene which, in turn, is also a novel satellite cell marker. In conclusion, Fra-2 protein stability is regulated by phosphorylation of ERK 1/2 in myogenic cells and its expression in quiescent reserve cells and in satellite cells suggests a possible role for Fra-2 in maintaining the undifferentiated state in myogenic progenitor cells.

## **Acknowledgements**

I would like to express my appreciation and gratitude to Dr. J.C. McDermott for the opportunity to do research in his lab. I've learned many valuable skills during my graduate studies, both at and away from the bench.

I've enjoyed working with all members of Dr. McDermott's laboratory. I would especially like to thank Dr. Tetsuaki Miyake and Dr. Arif Aziz for being my mentors, when I was an undergraduate in Dr. McDermott laboratory, and for their guidance through much of my graduate studies.

Finally, I would like to express my gratitude to my parents and my husband for their continued support and encouragement throughout my graduate studies.

### **Chapter III: Cardiotrophin-1 maintains the undifferentiated state in skeletal muscle development**

We thank Joseph Chan for technical assistance. We also thank Dr. Robert L. Perry for providing MyHC, Myogenin, and Myc antibodies and valuable suggestions. These studies were made possible by grants from the Natural Sciences and Engineering Research Council (NSERC) of Canada and the Canadian Institutes of Health Research (CIHR) to J.C.M.

### **Chapter IV: Signal dependent Fra-2 regulation in skeletal muscle reserve and satellite**

We thank S.J. Tapscott for sharing ChIP-seq data related to AP-1 binding sites in MyoD target genes. This work was supported by a grant from the Natural Sciences and Engineering Research Council (NSERC) of Canada to J.C. McDermott.

# Table of Contents

Abstract .....	ii
Acknowledgements .....	iii
Table of contents .....	iv
List of figures .....	vi
Abbreviations .....	viii

## Chapter 1: Review of literature

### Embryonic skeletal muscle development

1.1 Somitogenesis and the development of skeletal muscle .....	2
1.2 Limb development in the embryo .....	5

### Molecular regulation of skeletal muscle development

2.1 Specification by Pax3 and Pax7 .....	8
2.2 Determination and differentiation by the myogenic regulatory factors .....	9
2.3 Transcriptional control of MyoD .....	12
2.4 Signaling mechanisms in myogenesis .....	13

### Skeletal muscle regeneration

3.1 Characterization in identity of satellite cells .....	24
3.2 Molecular regulation of satellite cells .....	26
3.3 Signaling mechanism in satellite cells .....	29
3.4 Non-skeletal muscle cell types with regenerative potential .....	31

### Models used to investigate skeletal myogenesis

4.1 The C2C12 cell line .....	33
4.2 Primary single fibre cultures .....	33

### Activator Protein-1 transcription factor complex

5.1 Structural, physical and biological properties .....	35
5.2 The Jun and Fos family of transcription factors .....	38
5.3 JunB .....	39
5.4 JunD .....	39

5.5	FosB .....	40
5.6	Fos like antigen-1 .....	40
5.7	Fos like antigen-2 .....	41
5.8	Regulation by MAPK .....	42
5.5	Activator Protein-1 and Myogenesis .....	43

**Mitogen Activated Protein kinase pathways**

6.1	Mechanism of signal transduction .....	47
-----	--	----

**Cytokine and growth factor signaling in skeletal muscle differentiation**

7.1	Insulin, Insulin like growth factors, basic fibroblast growth factor and transforming growth factor-beta .....	50
7.2	Interleukin-6 family of cytokines .....	51
7.3	JAK-STAT signaling .....	52
7.4	Cardiotrophin-1 .....	56
7.5	Cardiotrophin-1 and myogenesis .....	56

Chapter II:	Statement of Purpose .....	58
-------------	----------------------------	----

Chapter III:	Cardiotrophin-1 maintains the undifferentiated state in skeletal muscle development .....	61
--------------	---	----

Chapter IV:	Signal dependent Fra-2 regulation in skeletal muscle reserve and satellite .....	109
-------------	--	-----

Chapter V:	Summary and Conclusions .....	159
------------	-------------------------------	-----

References .....	166
------------------	-----

**Appendices**

Appendix A:	Mustn1 as a novel AP-1 target gene in skeletal muscle cells .....	201
-------------	---	-----

Appendix B:	Methods .....	214
-------------	---------------	-----

# List of Figures

## Chapter I: Review of Literature

<b>Figure 1</b>	<b>Compartmentalization of somites during somitogenesis .....</b>	<b>3</b>
<b>Figure 2</b>	<b>Signaling mediating myotome specification in the somites .....</b>	<b>4</b>
<b>Figure 3</b>	<b>Somite segmentation and tissue derivatives .....</b>	<b>6</b>
<b>Figure 4</b>	<b>Muscle precursor cell migration and differentiation into limb muscles .....</b>	<b>7</b>
<b>Figure 5</b>	<b>Transcription factor expression during myogenesis .....</b>	<b>11</b>
<b>Figure 6</b>	<b>Molecular regulation of myogenesis and transcriptional control by MyoD .....</b>	<b>14</b>
<b>Figure 7</b>	<b>Signaling mechanisms in the somite that regulate muscle specific gene expression .....</b>	<b>18</b>
<b>Figure 8</b>	<b>Notch signaling in somites and satellite cells .....</b>	<b>19</b>
<b>Figure 9</b>	<b>Mechanism of Wnt signaling in mesodermal cells .....</b>	<b>20</b>
<b>Figure 10</b>	<b>Activation of proliferation and cell cycle progression in myoblasts by growth factors and cyclins .....</b>	<b>21</b>
<b>Figure 11</b>	<b>IGF signaling in myogenesis inhibits differentiation .....</b>	<b>22</b>
<b>Figure 12</b>	<b>Mechanism of p38 signaling in skeletal muscle differentiation .....</b>	<b>23</b>
<b>Figure 13</b>	<b>Anatomical location of satellite cells in muscle fibre .....</b>	<b>25</b>
<b>Figure 14</b>	<b>Symmetric and asymmetric satellite cell division .....</b>	<b>27</b>
<b>Figure 15</b>	<b>Satellite cells activation and self-renewal .....</b>	<b>28</b>
<b>Figure 16</b>	<b>The canonical and non-canonical Wnt signaling pathways in satellite cells .....</b>	<b>30</b>
<b>Figure 17</b>	<b>Culture models for skeletal muscle .....</b>	<b>34</b>
<b>Figure 18</b>	<b>Comparison of functional domains in AP-1 family members .....</b>	<b>37</b>
<b>Figure 19</b>	<b>Comparison of the C terminal domain of Fos family members .....</b>	<b>44</b>
<b>Figure 20</b>	<b>MAPK signaling cascades targeting AP-1 proteins .....</b>	<b>48</b>

Figure 21	IL-6 family of cytokines and their receptors .....	54
Figure 22	IL-6 cytokine induced signaling mechanism .....	55

**Chapter III: Cardiotrophin-1 maintains the undifferentiated state in skeletal myoblasts**

Figure 1	CT-1 represses myogenic differentiation .....	79
Figure 2	CT-1 represses the expression of pro-differentiation transcriptional regulators (MyoG and MEF2A/D) .....	83
Figure 3	Transcriptional induction of the <i>myoG</i> promoter by MyoD is repressed by CT-1 .....	83
Figure 4	Trans-activation properties of the MRF's are repressed .....	87-88
Figure 5	CT-1 inhibits the transcriptional activity of the MRF's through activation of MEK signaling .....	92-93
Figure 6	STAT3 activation by CT-1 is not sufficient for inhibition of myogenesis .....	97
Figure 7	CT-1 delays regeneration of damaged skeletal muscle .....	101
Supplemental figure 1 and Supplemental figure 2 .....		108

**Chapter IV: Signal dependent Fra-2 regulation in skeletal muscle reserve and satellite**

Figure 1	Fra-2 is a downstream target of the MEK 1/2-ERK 1/2 MAPK pathway .....	124
Figure 2	Identification of Fra-2 phospho-acceptor sites using phospho-peptide mass spectrometry analysis .....	128
Figure 3	Expression and stability of Fra-2 phospho-mutants in myogenic cells .....	134
Figure 4	Knockdown of Fra-2 enhances differentiation .....	137
Figure 5	Expression and localization of Fra-2 in myogenic cells .....	140
Figure 6	Fra-2 expression in satellite cells .....	143
Figure 7	MEK 1/2 inhibition activates satellite cell differentiation in primary muscle fibres .....	146

<b>Figure 8</b>	<b>Fra-2 phosphorylation may regulate muscle gene induction in C2C12 cells .....</b>	<b>148</b>
<b>S1</b>	<b>CT-1 transiently activates Fra-2 in C2C12 cells .....</b>	<b>156</b>
<b>S2</b>	<b>ERK 1/2 targets S320 and T322 are regulated sites on Fra-2 .....</b>	<b>157</b>
<b>S3</b>	<b>Neutralization of S320 and T322 on Fra-2 decreases protein expression .....</b>	<b>158</b>

**Chapter V: Summary and Conclusion**

<b>Figure 23</b>	<b>Summary of AP-1's role and regulation in skeletal muscle development .....</b>	<b>162</b>
------------------	---	------------

**Appendix A: Chapter VI: Mustn1 as a novel AP-1 target gene in skeletal muscle**

<b>Figure 1</b>	<b>MyoD ChIP data analysis of potential AP-1 target genes .....</b>	<b>208-209</b>
<b>Figure 2</b>	<b><i>mustn1</i> expression is increased in differentiating skeletal muscle .....</b>	<b>211</b>
<b>Figure 3</b>	<b>Fra-2 binds to the endogenous <i>mustn1</i> promoter in skeletal muscle .....</b>	<b>213</b>



## Abbreviations

<b>Akt</b>	<b>Protein Kinase B</b>
<b>ANP</b>	<b>Atrial natriuretic peptide</b>
<b>AP-1</b>	<b>Activator protein 1</b>
<b>Ash2L</b>	<b>Ash2 (absent, small, or homeotic)-like</b>
<b>ATF</b>	<b>Activating transcription factor</b>
<b>bHLH</b>	<b>Basic helix loop helix</b>
<b>BMP</b>	<b>Bone morphogenic protein</b>
<b>bZIP</b>	<b>Basic leucine zipper</b>
<b>C/EPB</b>	<b>CREB binding protein</b>
<b>CamKII</b>	<b>Ca<sup>2+</sup>/calmodulin-dependent protein kinase II</b>
<b>CDK</b>	<b>Cyclin dependent kinase</b>
<b>CIP/KIP</b>	<b>Cyclin dependent kinase-interacting protein/kinases inhibitor protein</b>
<b>CK</b>	<b>Casein kinase</b>
<b>CKI</b>	<b>CDK inhibitors</b>
<b>CLC</b>	<b>Cardiotrophin-like cytokine</b>
<b>CLS</b>	<b>CBF-1, Suppressor of Hairless, Lag-2</b>
<b>c-met</b>	<b>Hepatocyte growth factor receptor</b>
<b>CN</b>	<b>Calcineurin</b>
<b>CNTF</b>	<b>Ciliary neurotrophic factor</b>
<b>CRE</b>	<b>CREB response element</b>
<b>CREB</b>	<b>cAMP response element binding protein</b>
<b>CT-1</b>	<b>Cardiotrophin-1</b>
<b>Dsh</b>	<b>Dishevelled</b>

<b>EDL</b>	<b>Extensor digitorum longus</b>
<b>EMT</b>	<b>Epithelial to mesenchymal transition</b>
<b>ER</b>	<b>Endoplasmic reticulum</b>
<b>ERK</b>	<b>Extracellular signal regulated kinase</b>
<b>FACS</b>	<b>Fluorescence activated cell sorting</b>
<b>FGF</b>	<b>Fibroblast growth factor</b>
<b>FoxO1</b>	<b>Forkhead box protein O1</b>
<b>Fra</b>	<b>Fos related antigen</b>
<b>Fzd</b>	<b>Frizzled receptor</b>
<b>Gab2</b>	<b>Grb2 associated binder</b>
<b>gp130</b>	<b>Glycoprotein 130</b>
<b>Grb2</b>	<b>Growth factor bound protein 2</b>
<b>GSK3-β</b>	<b>Glycogen synthases 3 β</b>
<b>HAT</b>	<b>Histone acetyl transferase</b>
<b>HDAC</b>	<b>Histone deacetylases</b>
<b>HGF</b>	<b>Hepatocyte growth factor</b>
<b>IGF</b>	<b>Insulin-like growth factor</b>
<b>IGFR</b>	<b>Insulin-like growth factor receptor</b>
<b>IL</b>	<b>Interleukin</b>
<b>INK4</b>	<b>Inhibitor of CDK4</b>
<b>IP<sub>3</sub></b>	<b>Inositol trisphosphate</b>
<b>IRS</b>	<b>Insulin receptor substrate</b>
<b>JAK</b>	<b>Janus kinase</b>
<b>JLP</b>	<b>JNK-associated leucine zipper protein</b>
<b>JNK</b>	<b>c-Jun N-terminal kinases</b>

<b>Lbx</b>	<b>Ladybird homeobox protein</b>
<b>LIF</b>	<b>Leukemia inhibitory factor</b>
<b>LIFR</b>	<b>Leukemia inhibitory factor receptor</b>
<b>LRP</b>	<b>Lipoprotein receptor-related protein</b>
<b>MADS</b>	<b>MCMI, agamous, deficiens, serum response factor</b>
<b>Maf</b>	<b>Musculoaponeurotic fibrosarcoma</b>
<b>MB</b>	<b>Myoblast</b>
<b>MCK</b>	<b>Muscle creatine kinase</b>
<b>MEF2</b>	<b>Myocyte enhancer factor 2</b>
<b>MEK</b>	<b>MAPKK (mitogen-activated protein kinase kinase)</b>
<b>MKK</b>	<b>MAPKK (mitogen-activated protein kinase kinase)</b>
<b>MRF</b>	<b>Myogenic regulatory factor</b>
<b>MT</b>	<b>Myotube</b>
<b>mTOR</b>	<b>mammalian target of rapamycin</b>
<b>MyHC</b>	<b>Myosin heavy chain</b>
<b>NFAT</b>	<b>Nuclear factor of activated T-cells</b>
<b>NICD</b>	<b>Notch intracellular domain</b>
<b>NT3</b>	<b>Neurotrophin-3</b>
<b>OSM</b>	<b>Oncostatin M</b>
<b>Pax</b>	<b>Paired box protein</b>
<b>PI3K</b>	<b>Phosphatidylinositol-4,5-bisphosphate 3-kinase</b>
<b>PIP<sub>3</sub></b>	<b>Phosphatidylinositol (3,4,5)-trisphosphate</b>
<b>Pitx2</b>	<b>Pituitary homeobox 2</b>
<b>PKA</b>	<b>Protein kinase A</b>
<b>PKC</b>	<b>Protein kinase C</b>

<b>PKD</b>	<b>phosphoinositide dependent protein kinase</b>
<b>PLC</b>	<b>Phospholipase C</b>
<b>PTB</b>	<b>Phosphotyrosine binding</b>
<b>Rac</b>	<b>Ras-related C3 botulinum toxin substrate</b>
<b>Rb</b>	<b>Retinoblastoma</b>
<b>RBPJ</b>	<b>Recombining binding protein suppressor of hairless</b>
<b>Rho</b>	<b>GTPase</b>
<b>ROCK</b>	<b>Rho kinase</b>
<b>SH2</b>	<b>Src homology 2</b>
<b>Shh</b>	<b>Sonic hedgehog</b>
<b>SHP2</b>	<b>SH2 domain containing phosphatase</b>
<b>Six</b>	<b>Sinus Occulus homeobox protein</b>
<b>SP</b>	<b>Side population</b>
<b>SRF</b>	<b>Serum response factor</b>
<b>STAT</b>	<b>Signal transducer and activator of transcription</b>
<b>TA</b>	<b>Tibialis anterior</b>
<b>TAK</b>	<b>Transforming growth factor-<math>\beta</math> activator kinase</b>
<b>TCF/LEF</b>	<b>Transcription factor/Lymphoid enhancer-binding factor</b>
<b>TGF-<math>\beta</math></b>	<b>Transforming growth factor-<math>\beta</math></b>
<b>TPA</b>	<b>12-O-tetradecanolyphorbol 13-acetate</b>
<b>TRE</b>	<b>TPA response element</b>
<b>TYK</b>	<b>Tyrosine kinase</b>
<b>Wnt</b>	<b>Wingless related MMTV integration site</b>

# **Chapter I: Review of literature**

## **Chapter I: Review of literature**

### **Embryonic skeletal muscle development**

#### *1.1 Somitogenesis and the development of skeletal muscle*

During embryogenesis, the process of skeletal muscle development termed myogenesis, is initiated in structures known as the somites (Buckingham, 2001; Buckingham et al. (2003)). Somites are highly condensed blocks of paraxial mesoderm that form rostral to caudal and run parallel along either side of the neural tube during embryogenesis (figure 1). As development progresses, signals from nearby tissues induce the somites to compartmentalize into the sclerotome and the dermomyotome (Buckingham et al., 2003; Pownall et al., 2002; Wagner et al., 2000). The ventromedial section of the somite becomes the sclerotome due to the signaling molecule sonic hedgehog (Shh), which emanate from the notochord and neural tube. The dermomyotome is specified by Wnt signaling from the overlying epidermis, which undergoes an epithelial to mesenchymal transition (EMT) when neurotrophin-3 (NT3) and Wnt1 signals are received from the neural tube. Cells from the dorsal medial part of the somite migrate under the dermomyotome and form the myotome, which is specified by Wnt signals from the neural tube, epidermis and lateral plate mesoderm (figure 1, figure 2). Cells of the dermomyotome responding to Wnt1 and Wnt3 have increased levels of Myf5, where as Wnt6 and Wnt7a increase MyoD expression. In contrast, BMP4 from the lateral mesoderm repress myogenic gene expression, thereby preventing premature activation on MyoD (figure 2) (Tajbakhsh et al., 1998). Taken together, the expression of Shh, Wnts and BMP molecules control expansion and differentiation of skeletal muscle during development.

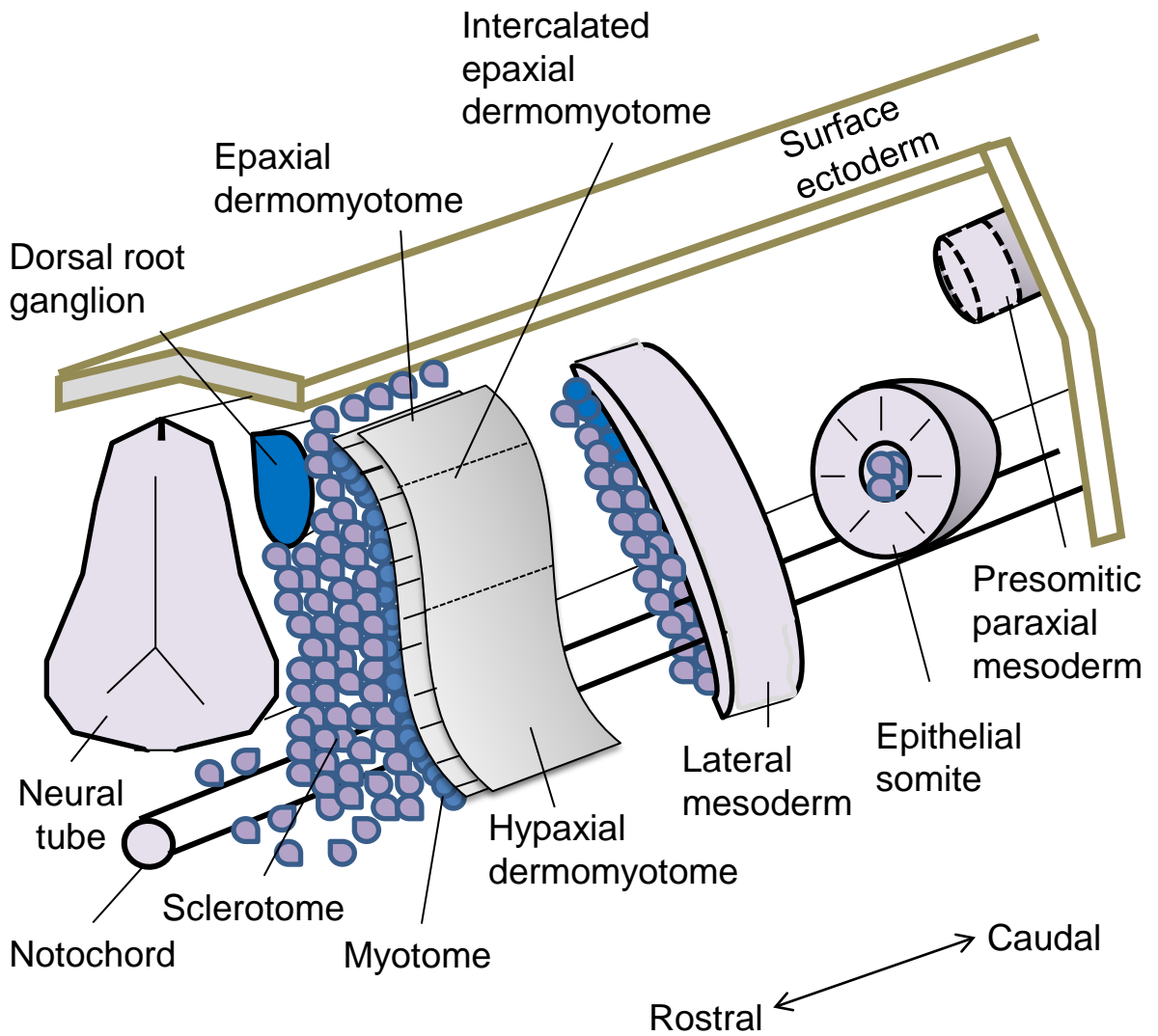

**Figure 1. Compartmentalization of somites during embryogenesis.**

Epithelial somitic segmentation occurs from rostral to caudal and parallel to the neural tube and notochord in the developing embryo. The somite gives rise to the dermomyotome and the sclerotome. The myotome forms under the dermomyotome and gives rise to muscle progenitor cells.

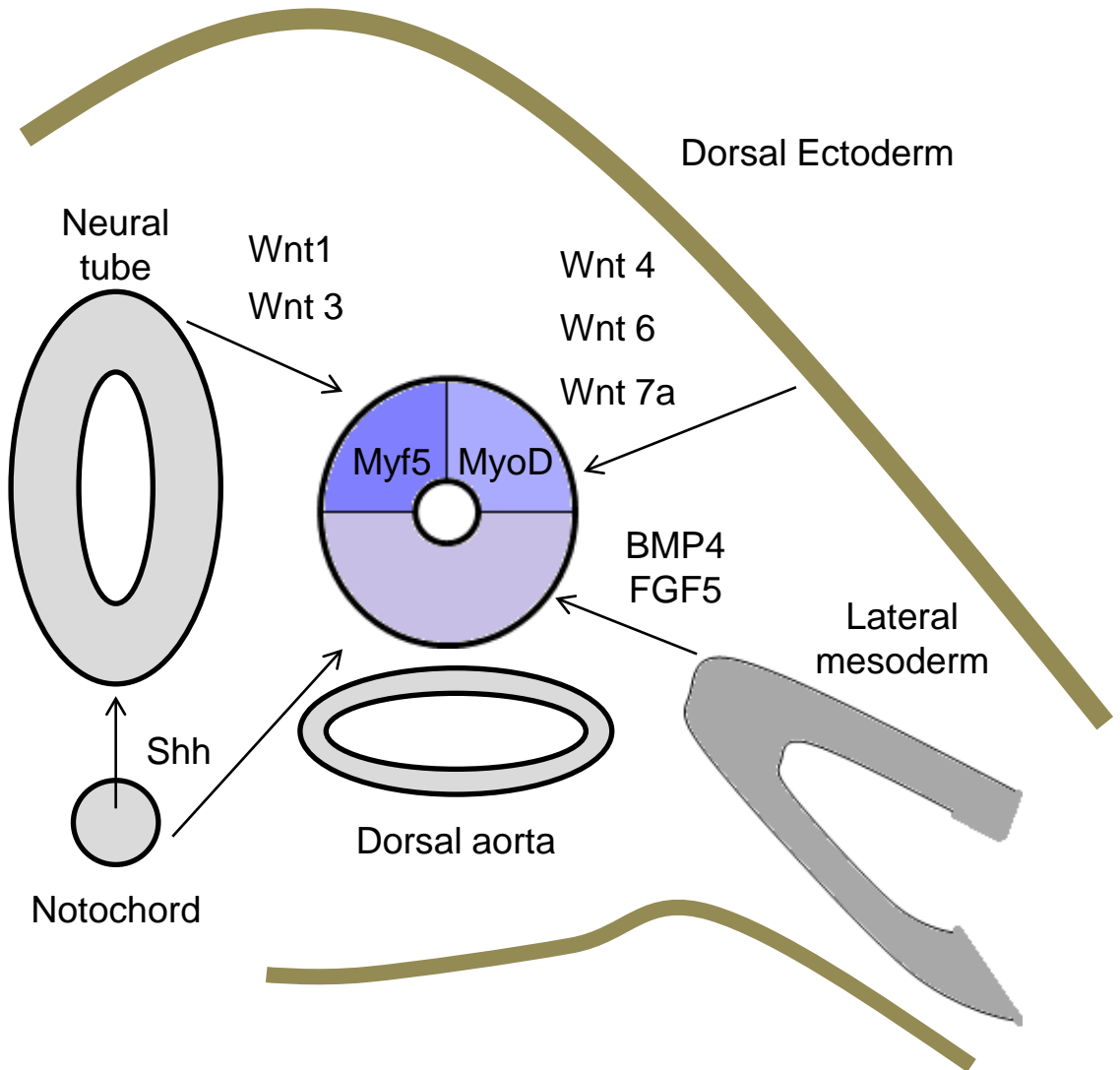

**Figure 2. Signaling mediating myotome specification in the somites.**

Wnt1 and Wnt3 signaling from the neural tube induce Myf5 expression in the dorsal somite. Wnt 4, 6, and 7a signaling from the dorsal ectoderm activates MyoD expression. Inhibitory signals such as sonic hedgehog (Shh) from the notochord repress Myf5 expression. Bone morphogenetic protein 4 (BMP4) and fibroblast growth factors (FGF) from the lateral plate mesoderm inhibit expression of myogenic genes in the ventral somite.



These signaling events define specific sections within the somite, allowing for different tissue types to arise from somatic mesoderm. Ultimately, the sclerotome will give rise to cartilage of vertebral column and ribs, while dermomyotome will become dermis, brown fat and trunk muscles. The dermomyotome further divides into the dermatome and myotome, which can be further divided into epaxial and hypaxial sections that will generate muscle precursor cells. Cells from the dorsal myotome become epaxial (back) muscles, while cells from the lateral myotome contribute to the hypaxial (limb) muscles (figure 3) (Pownall et al., 2002).

### ***1.2 Limb development in the embryo***

Limb formation is initiated in the somites when Pax3 expressing cells originating from the myotome delaminate and express c-met, a tyrosine kinase receptor for hepatocyte growth factor (HGF), which along with Lbx1 are expressed in migrating cells. As migration continues, Pax3 and Six1 transcription factors activate the myogenic commitment genes MyoD and Myf5. MyoD and Myf5 expressing cells are committed myogenic cells, termed myoblast, that continue to migrate to the limbs axial structures and dorsal regions of the embryo, where they proliferate, fuse and terminally differentiate into multinucleated myotubes that express differentiation factors, such as Myogenin (figure 4) (Buckingham et al., 2003; Molkentin and Olson, 1996b; Williams and Ordahl, 2000). Terminally differentiated myotubes (myocytes) are the subunits of skeletal muscle and possesses the capacity to self repair following injury by reactivating the myogenic program in muscle stem cells, called satellite cells. These events collectively encompass skeletal muscle differentiation, which is a complex process that has been extensively studied and has provided considerable insight into

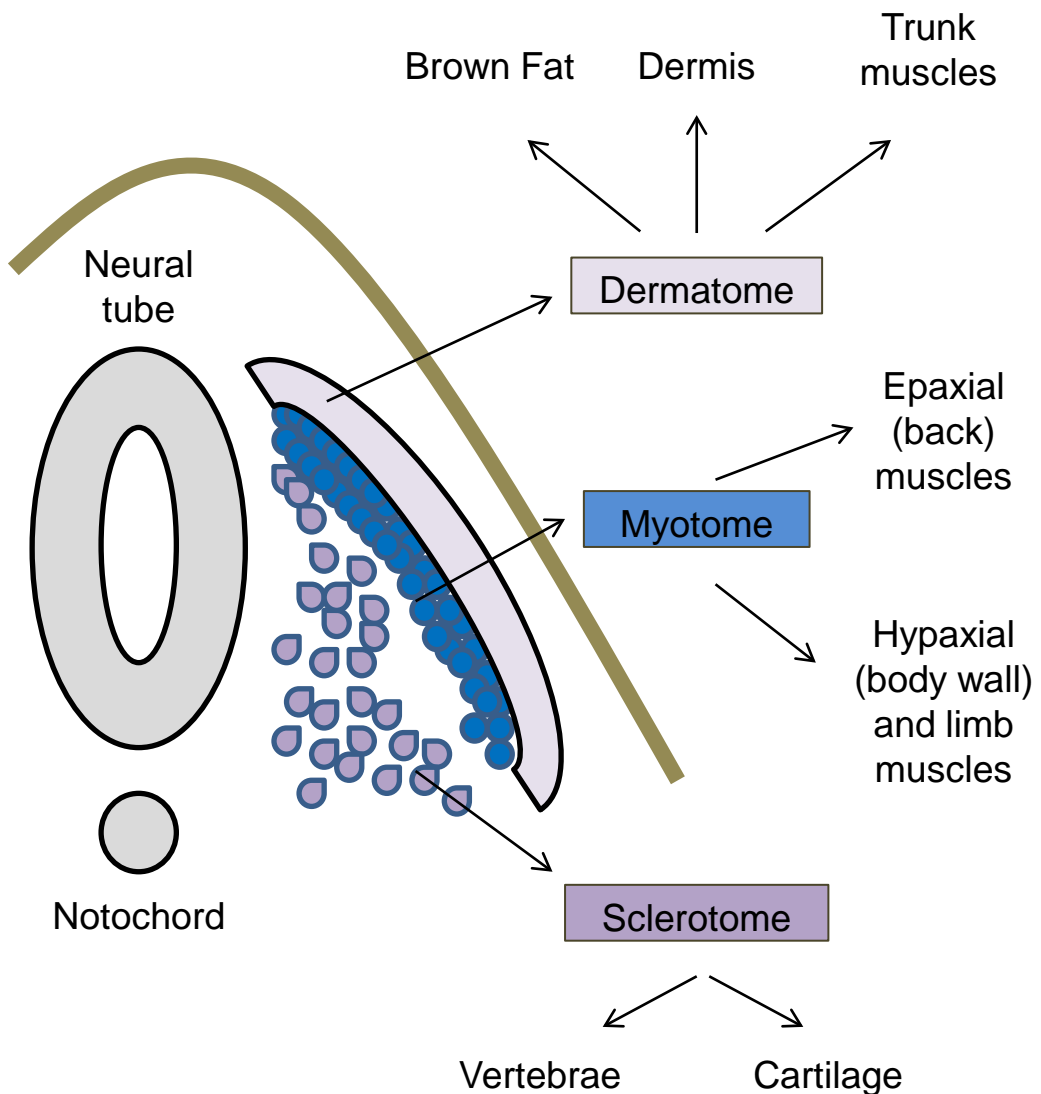

**Figure 3. Somite segmentation and tissue derivatives.**

Cells of the somite segregate into the dermatome, myotome and sclerotome. Brown fat, dermis and trunk muscles are derived from the dermatome. The myotome gives rise to back (epaxial), body wall (hypaxial), and limb muscles. The vertebrae and cartilage originate from the sclerotome.

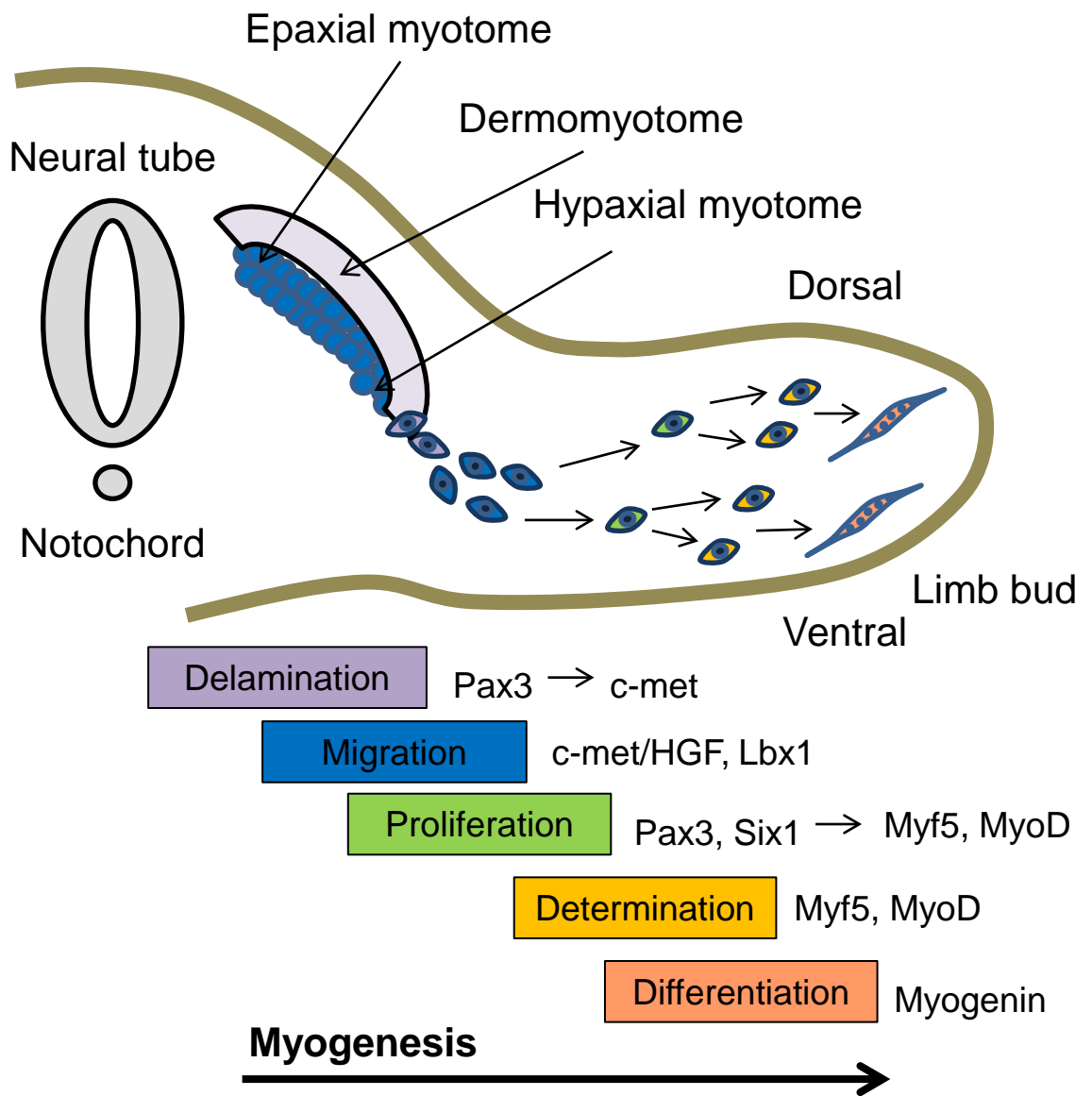

**Figure 4. Muscle precursor cell migration and differentiation into limb muscles.** Muscle precursor cells originating from the myotome express transcription factor Pax3. Pax3 induces the expression of a receptor c-met as these cells delaminate. The muscle precursor cells delaminate and begin to migrate. Hepatocyte growth factor (HGF) activates the c-met receptor and induces expression of Lbx1. During migration these cells proliferate and Pax3 and Six1 mediate expression of Myf5 and MyoD. The muscle precursor cells reach the limb bud and express the myogenic determination factors Myf5 and MyoD which activate the expression of the differentiation marker, Myogenin.

cell lineage commitment and differentiation (Buckingham et al., 2003; Gerber et al., 1997).

## **Molecular regulation of embryonic skeletal muscle development**

Skeletal muscle development is an intricate process regulated by skeletal muscle specific transcription factors in co-ordination with other non muscle specific regulatory proteins. The mechanisms involved in these processes are well understood. The regulatory molecules involved in generation of skeletal muscle can be divided into specification, determination, differentiation, and maintenance factors and will be discussed in the subsequent sections.

### ***2.1 Specification by Pax3 and Pax7***

The paired homeobox (Paxton et al.) transcription factors Pax3 and Pax7 are involved in lineage specification of skeletal muscle during development. Pax3 is initially expressed in the presomitic paraxial mesoderm before segmentation of the somites; it is detected in the epithelial of the somites before being restricted to the dermomyotome. Pax3 is required for hypaxial muscle of the trunk and for delamination and migration of myogenic precursor cells. Cells in the dermomyotome that are specified by Pax3, give rise to Pax7 positive cells, which will become the embryonic and fetal muscle cells (Kuang et al., 2006). Embryonic progenitor cells expressing Pax3 and Pax7 contribute to satellite cells in the trunk and limb muscles. Pax3 is expressed in both muscle and non-muscle cells and its regulation is determined by Six1 and Six 4, which are transcription factors that also regulate MyoD, MRF4 and Myogenin (Grifone et al., 2005). Interestingly, only Pax3 is expressed in myogenic cell

migrating to limb structures. Pax3 is important during embryonic myogenesis, since the Pax3 mutant mice called *splotch* do not express MyoD and lack limb muscles, due to lack of migration of muscle precursor cells (Franz and Kothary, 1993).

Pax7 is involved in postnatal skeletal muscle growth and maintenance. Pax7 is expressed in the somite, but is restricted to the dermomyotome and activates MyoD and Myf5. The Pax7 knockout mouse was generated by Mansouri et al., (Mansouri et al., 1996) and it was reported that these mice had abnormalities in facial structures (maxilla and nose) due to cephalic neural crest defects and could not detect any obvious effects on central nervous system and skeletal muscle. However, Seale et al, 2000 connected Pax7 to skeletal muscle when they collaborated with the group that made the Pax7 knockout and reported that Pax7 was important for satellite cell specification, since loss of Pax7 resulted in satellite cell depletion (Seale et al., 2000), demonstrating that Pax7 knockout mice are deficient in satellite cells and cannot regenerate muscle post injury, thus Pax7 is more important for postnatal myogenesis. Interestingly, Olguin et al., suggested that the MRFs, namely Myogenin affects Pax7 levels and Pax7 effects MyoD stability, which suggest autoregulatory loop for Pax7 expression (Olguin et al., 2007).

## ***2.2 Determination and differentiation by the myogenic regulatory factors***

Skeletal myogenesis requires co-ordinated expression and regulation of the myogenic regulatory factors (MRFs), MyoD, Myf-5, MRF4 and Myogenin (Molkentin and Olson, 1996b; Pownall et al., 2002; Tapscott et al., 1990). MyoD was the initial muscle specific transcription factor determined from a screen for transcripts upregulated in a fibroblast conversion assay (Lassar et al., 1986). The MRFs are basic helix-loop-helix (bHLH) transcription factors that are temporally and spatially

expressed during embryonic development and are the primary regulators of muscle progenitor cell specification and differentiation (Bergstrom and Tapscott, 2001; Molkenin and Olson, 1996b; Pownall et al., 2002). The MRFs contain a conserved muscle recognition site defined by ATK in the basic domain, which specifies activation of muscle specific genes (Davis et al., 1990). During somitogenesis, MyoD and Myf5 expression regulates commitment of pluripotent mesodermal cells into the myogenic lineage (Asakura et al., 1995; Pownall et al., 2002; Williams and Ordahl, 2000). MRF4 and Myogenin transcription is dependent on MyoD and Myf5 and are up-regulated during muscle differentiation and required *in vivo* for normal muscle differentiation (figure 5) (Bergstrom and Tapscott, 2001; Cheng et al., 1995; Pownall et al., 2002).

The critical role for MRF expression during development is demonstrated by aberrant muscle formation in targeted gene ablation studies performed in mice (Arnold and Winter, 1998). Both *myoD* (-/-) and *myf5* (-/-) mice are viable, however, mice with gene disruptions for both *myoD* and *myf5* do not form skeletal muscle and die at birth (Kablar et al., 1997; Rawls et al., 1995; Sabourin et al., 1999). Consistent with roles in muscle cell determination compound gene targeted mice (*myod*<sup>-/-</sup>, *myf5*<sup>-/-</sup>) have no muscle, but single knockouts are minimally affected suggesting that *myoD* and *myf5* can compensate for each other (Kablar et al., 1997). The *myogenin* (-/-) and *mrf4* (-/-) null mice have myoblasts that express *myoD* and *myf5*, but differentiated muscle is absent, demonstrating that these factors are required for differentiation but likely not commitment (Arnold and Braun, 1996; Rawls et al., 1995; Zhang et al., 1995a). In view of the fact that the MRFs have such an important role in myogenesis, it has been of interest to study how these transcription factors are regulated.

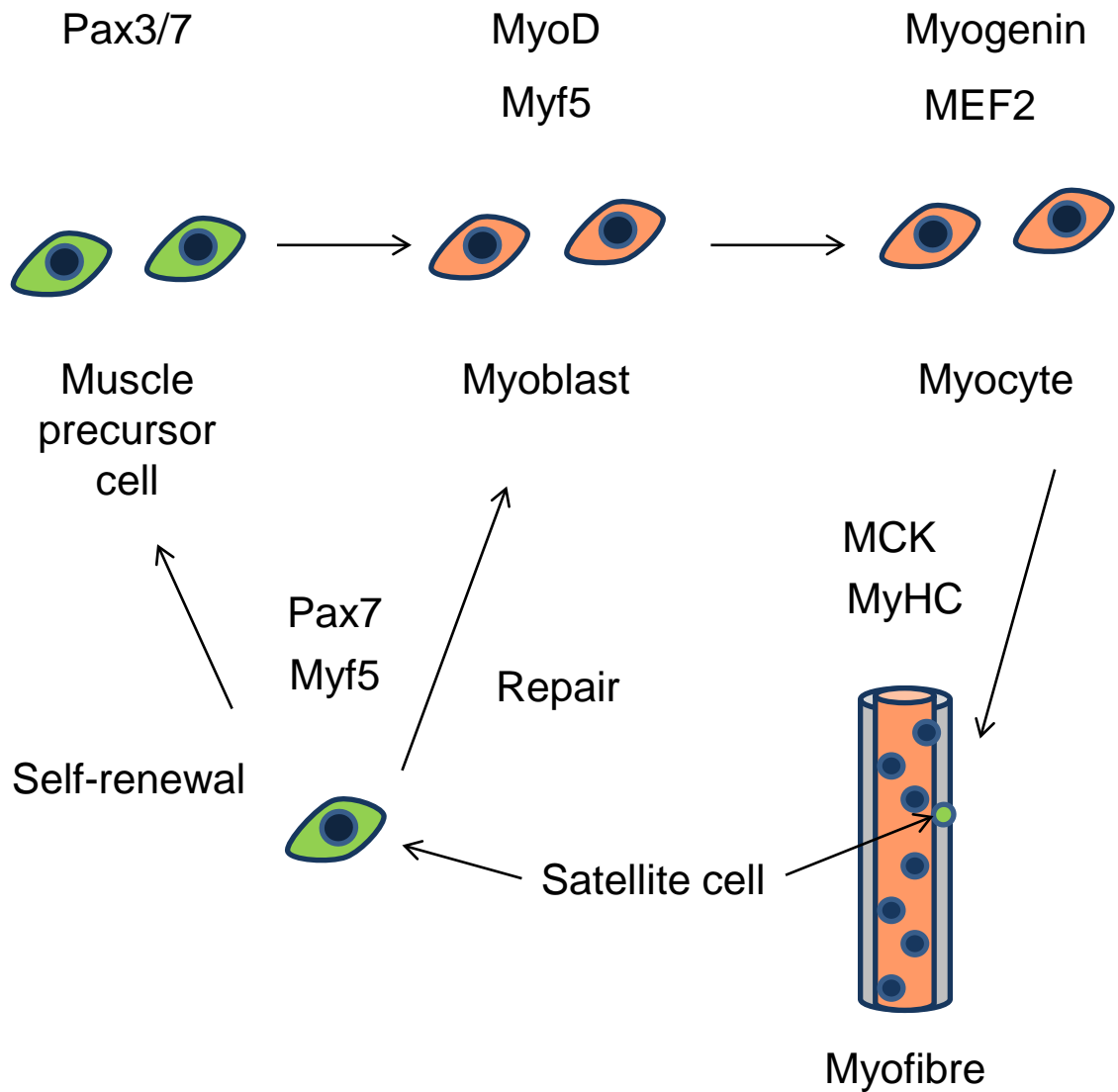

**Figure 5. Transcription factor expression during myogenesis.**

Muscle precursor cells express Pax3 and Pax7 transcription factors which activate the myogenic commitment factors MyoD and Myf5. Cells committed to the myogenic lineage, termed myoblasts, become myocytes and express MyoD, Myf5 and MEF2 transcription factors that regulate expression of Myogenin, an early differentiation marker. Differentiating myocytes fuse together forming multinucleated myofibres that express markers such as muscle creatine kinase (MCK) and myosin heavy chain (MyHC). Myofibres contain adult muscle stem cells called satellite cells that express Pax7 and Myf5. Once activated satellite cells may repair injured fibres, form a new fibre, or self-renew.

### ***2.3 Transcriptional control by MyoD***

The MRFs are muscle specific transcription factors that are required for skeletal myogenesis, however, they co-operate with other factors that aid in augmenting gene expression. The MRFs can physically interact with the ubiquitously expressed E-box proteins (E2, E12/E47, HEB), which are also members of the bHLH family (Abe et al., 2004; Becker et al., 2001; Berkes and Tapscott, 2005; Conway et al., 2004; Lluís et al., 2005; Parker et al., 2006). Such interactions with E proteins allows MRF to bind to E-boxes defined by 5'CANNTG'3 consensus sequence and activate muscle specific gene transcription (Berkes and Tapscott, 2005). Other bHLH proteins, such as Id, MyoR, Twist and Mist-1, also interact with MRFs, but are inhibitory to muscle gene expression as they interact with E-protein preventing them from interacting with the MRFs (Lemercier et al., 1998; Neuhold and Wold, 1993; Spicer et al., 1996).

Myocyte enhancer factor 2 (MEF2) family of transcription factors are MADS (MCMI, agamous, deficiens, serum response factor) box proteins that bind to AT rich sites identified by 5'C/TTA(AT)<sub>4</sub>TAG/A'. Of the four isoforms, MEF2A, C and D are found in skeletal muscle (Buchberger and Arnold, 1999; Dodou et al., 2003; Puri and Sartorelli, 2000; Wang et al., 2001). MEF2 synergistically regulates muscle-specific gene expression in co-operation with the MRFs, specifically MyoD (Berkes and Tapscott, 2005; Dodou et al., 2003). However, MEF2 proteins may act repressively with MyoD, as they are known to interact with HDAC4 and HDAC5, both class II HDACS which repress gene expression.

Besides the bHLH, MyoD has other functional domains that are important for its' function. A transactivation domain is found in the N-terminus, and it has a



histidine and cysteine rich domain, as well as a helix III domain involved in chromatin remodelling (Gerber et al., 1997). MyoD is known to interact with histone acetyltransferase (HATs) and histone deacetylases (HDACs). Two HATs involved in expression of muscle specific genes are p300 and PCAF, which both interact with MyoD as coactivators (Puri et al., 1997). MyoD recruits p300 to the promoter to acetylate histones followed by PCAF recruitment that acetylates MyoD. Both acetylation events increase DNA binding and transcription, leading to positive expression of muscle specific genes, such as Myogenin (figure 6) (Dilworth et al., 2004). Although MyoD positively regulates gene expression, it can interact with Class I histone deacetylases (HDAC1) to negatively regulate muscle genes (Puri et al., 2001). Muscle specific target genes regulated by the MyoD include myogenin and muscle creatine kinase (MCK) (Lassar et al., 1989; Qin et al., 1998) and myosin heavy chain (MyHC) (Allen et al., 2001), which are markers of terminal differentiation.

#### ***2.4 Signaling mechanism in myogenesis***

In the embryo, signals received from the notochord, neural tube and lateral plate mesoderm specify Pax3, Myf5 and MyoD in the somite. The pathways involved in mediating specification are the canonical and non-canonical Wnt (Tajbakhsh et al., 1998), Shh (Borycki et al., 1999), BMP (Reshef et al., 1998) and Notch pathways (Hirsinger et al., 2001). Wnt1, Wnt3 and Shh mediate Myf5 expression, while Wnt 4, Wnt6 and Wnt7a along with BMP4 (figure 7) and Notch regulate MyoD (figure 8). Wnt 1 and Wnt3a signal via the canonical Wnt signaling pathway (figure 7). In the canonical pathway, Wnt signals via the Fzd receptor activating Dsh, which inhibits GSK3- $\beta$  from phosphorylating  $\beta$ -Catenin, thus preventing its targeted degradation.

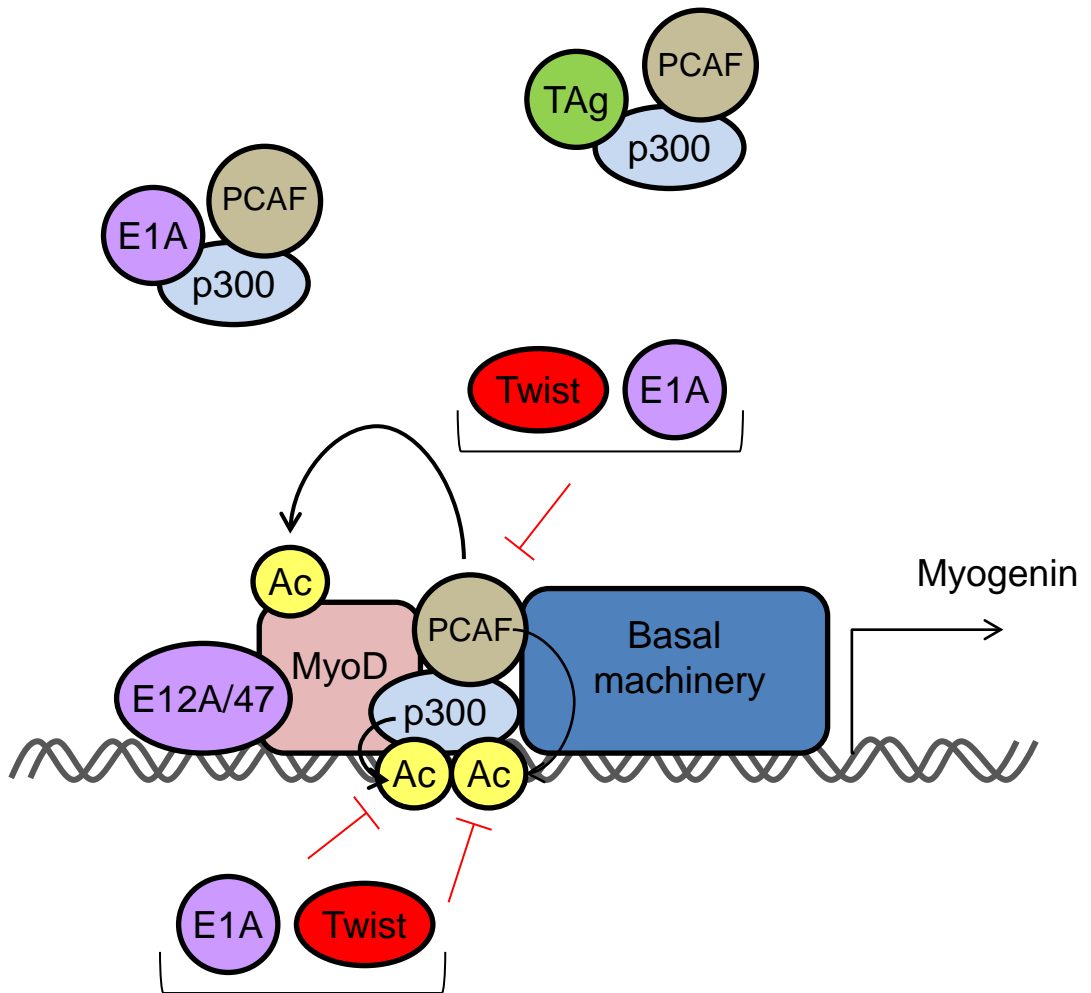

**Figure 6. Molecular regulation of myogenesis and transcriptional control by MyoD.**

MyoD mediates chromatin remodelling on the *myogenin* gene by recruiting the histone acetyl transferase, p300 to DNA. Once recruited, p300 acetylates histones along with PCAF. Together with p300, PCAF actelylates histones promoting gene transcription.

Stabilization of  $\beta$ -Catenin allows it to translocate into the nucleus and interact with TCF to activate Myf5 and Pax3 transcription. Additionally, Shh binds to the Patched receptor resulting in the dissociation of an inhibitory protein termed smoothened, which leads to the activation of the Gli transcription factor that also mediates Myf5 expression (figure 7) (Gustafsson et al., 2002). The BMPs activate R-Smads, which translocate into the nucleus and together with Smad4, inhibit MyoD expression while not affecting Pax3 (figure 7). The non-canonical Wnt signaling pathway is initiated in the dermomyotome by Wnt7a, which activates the PKA pathway leading to the phosphorylation of CREB that induces expression of the myogenic commitment factors MyoD, Myf5 and Pax3, and also the specification of the myotome (figure 9) (Chen et al., 2005). Conversely, PKA also represses transcriptional activity of Myf5, MyoD and Myogenin independently of direct phosphorylation (Winter et al., 1993). However, PKA can directly phosphorylate MEF2, inhibiting its activity (Du et al., 2008) and preventing myogenic differentiation.

In committed proliferating myoblasts, cyclins and cyclin dependent kinases (CDK) regulate cell cycle progression through G<sub>1</sub> to S phase and entry into mitosis. CyclinD/CDK4 and cyclinE/CDK2 inhibit transcriptional activity of MyoD, thereby repressing transcription of muscle specific genes (Rao et al., 1994). Cyclin E also activates CDK2, which phosphorylates Rb preventing interaction with E2F, thus allowing cell cycle progression. Phosphorylation of Rb also prevents interaction with MyoD, leading to inhibition of S phase entry and no differentiation (Gu et al., 1993). Additionally, cyclinE/CDK2 can directly phosphorylate MyoD on S200 targeting it for protein degradation in G<sub>1</sub>, inhibiting differentiation (figure 10) (Kitzmann et al., 1999).

These events collectively regulate cell cycle progression, and promote MB proliferation and expansion. For differentiation to proceed, CDK inhibitors (CKIs) are elevated leading to inhibition of cell cycle mediators. CKIs are members of the inhibitor of CDK4 (INK4) family, which include p16, p18 and p19, and are also members of cyclin dependent kinase-interacting protein/kinases inhibitor protein (CIP/KIP) that include p21, p27 and p57. CKIs lead to a repression of CDK activity, which decreases Rb phosphorylation and promotes cell cycle exit and an increase in MyoD protein (Knudsen et al., 1998). MyoD can induce muscle gene expression leading to differentiation. Non cell cycle cyclin and CDKs are also involved in regulating differentiation. P35/CDK5 can phosphorylate Nestin, which regulates the rate of MB differentiation and cyclin T/CDK9 promotes MyoD activity (Simone et al., 2002).

ERK 1/2 signaling is active in many cell types including skeletal muscle. ERK 1/2 signaling has a role in different stages of skeletal muscle development including proliferation (figure 10) (Jones et al., 2001) and later stages of differentiation (Adi et al., 2002). Growth factors, such as Fibroblast growth factors (FGF) and Insulin like growth factor (IGF), are involved in activation of the ERK 1/2 pathway that stimulate proliferation of MB possibly inhibiting expression of p21 and MyoD. Although ERK 1/2 targets are uncharacterized, it has been demonstrated that MEK 1/2, which is activated by the same cytokines and growth factors stimulating ERK 1/2, can physically interact with MyoD preventing its ability to transactivate *myogenin* (Miyake et al., 2009). The Akt pathway is also activated by IGF and acts a positive regulator of proliferation. Signaling initiated by IGF-I activates PI3 kinase that activates Akt and inhibits ERK 1/2, thus promoting myogenesis (Kaliman et al., 1996; Milasincic et al.,

1996; Minami et al., 2011). Once phosphorylated, Akt inhibits FoxO1 from stimulating transcription of p27, a cell cycle inhibitor (figure 11) (Machida et al., 2003).

Another member of the MAPK family, p38 is important for regulation of differentiation. The p38 MAPK has four isoforms ( $\alpha$ ,  $\beta$ ,  $\gamma$ ,  $\delta$ ), two of which ( $\alpha$  and  $\beta$ ) have been shown to phosphorylate molecules that positively regulate myoblast differentiation (Cuenda and Cohen, 1999; Zetser et al., 1999). The extracellular components of the p38 pathway are undefined, but it is known that transforming growth factor- $\beta$  activated kinase 1 (TAK1) phosphorylates MKK3/6, which phosphorylates p38 (Bhatnagar et al., 2010). One other mechanism involving cell to cell contact has been investigated. N-cadherin on adjacent cells activates Cdo that complexes with other proteins including Cdc42 (a GTPase), which phosphorylates p38 (Lu and Krauss, 2010). Activated p38 can phosphorylate MEF2, which recruits Ash2L to the promoter leading to activation. Phosphorylation of E47 by p38 allows interaction with MyoD, also promoting expression of muscle specific genes (figure 12) (Lluis et al., 2005). MEF2A and MEF2C are also MyoD interacting partners that are phosphorylated by the p38 MAPK regulating its transcriptional activity (Cox et al., 2003; Zetser et al., 1999). Additionally, p38 also promotes differentiation by repressing gene expression of Pax7 via phosphorylation of chromatin repressors (Palacios et al., 2010). Thus, activation and repression of genes dependent on p38 phosphorylation is required for myogenic differentiation.

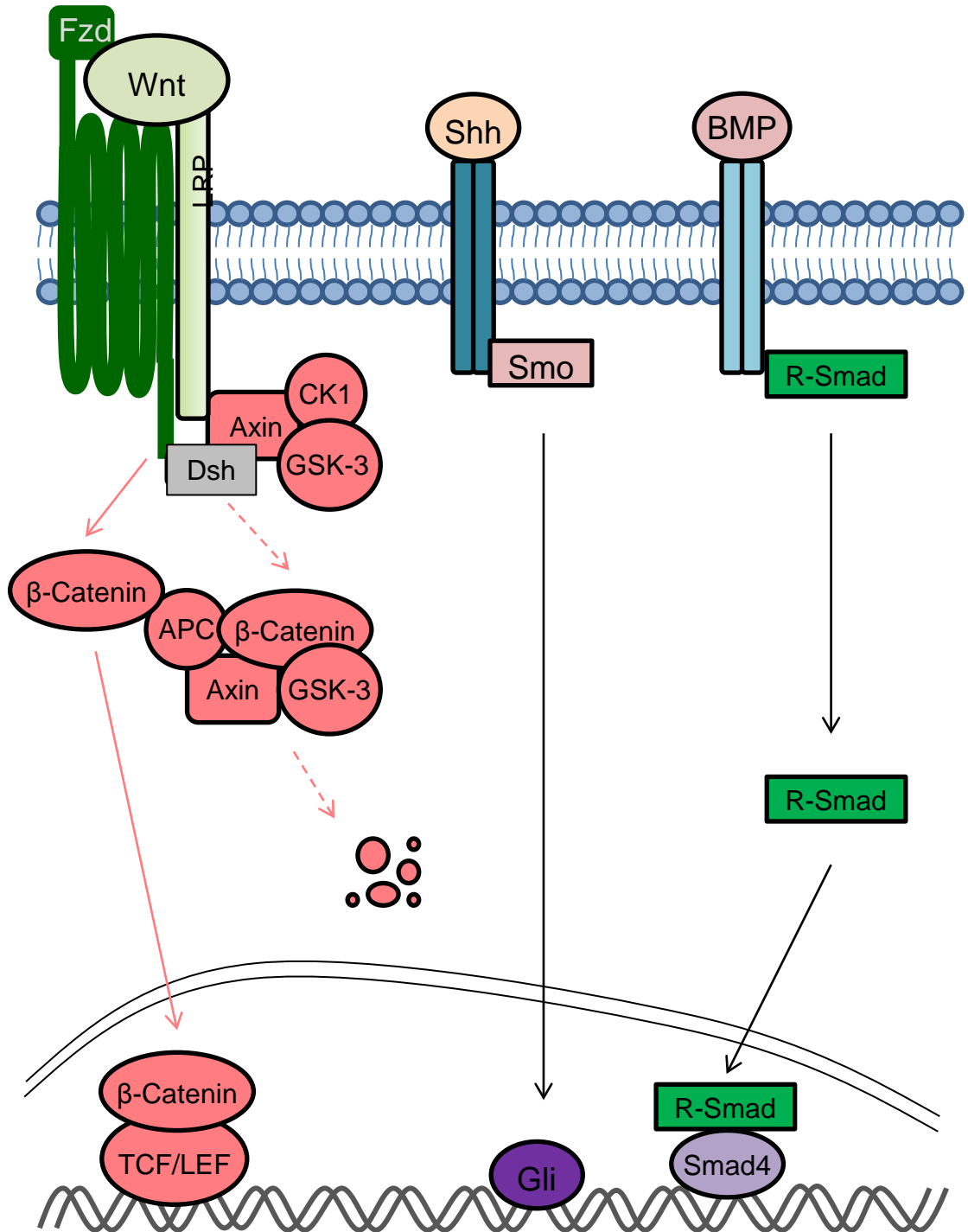

**Figure 7. Signaling mechanisms in the somite that regulate muscle specific gene expression.**

Canonical Wnt signaling is activated by interaction of Wnt1/3 with the Frizzled (Fzd) receptor resulting in activation of Dishevelled (Dsh). Sonic hedgehog (Shh) binds to the Patched receptor activating Gli proteins, and Bone morphogenetic proteins (BMPs) stimulate activation of type I and II receptor leading to activation of Smads 2/3 which can interact with Smad 4 and regulate Myf5 expression.

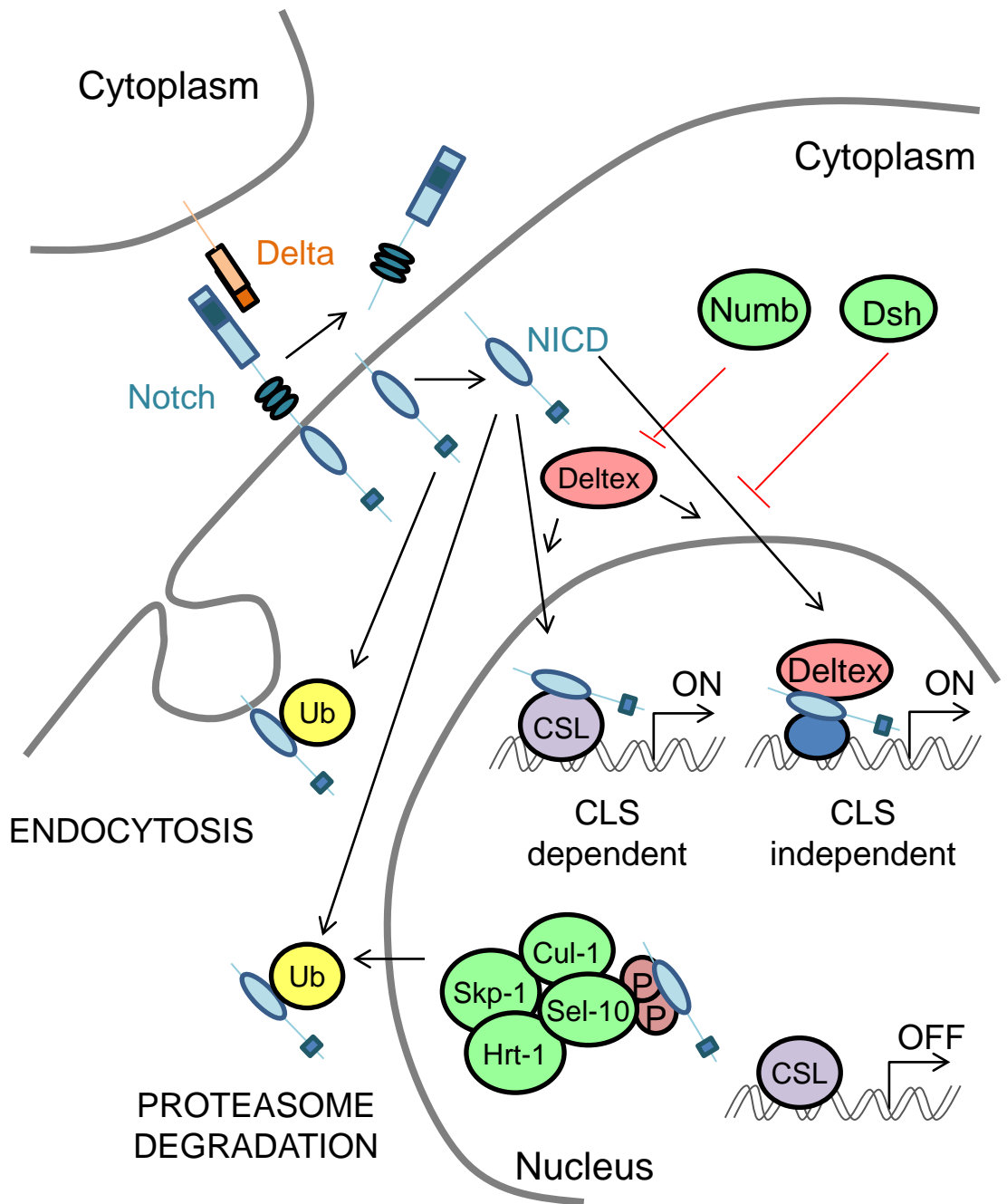

**Figure 8. Notch signaling in somites and satellite cells.**

The Notch receptor and its Delta ligand interact causing the Notch intracellular domain (NICD) to be cleaved. The NICD can be endocytosed or targeted for degradation. The NICD may also enter the nucleus and interact with CSL to turn on genes that have been shown to inhibit MyoD. Numb and Dishevelled (Dsh) can inhibit the Notch signaling pathway.

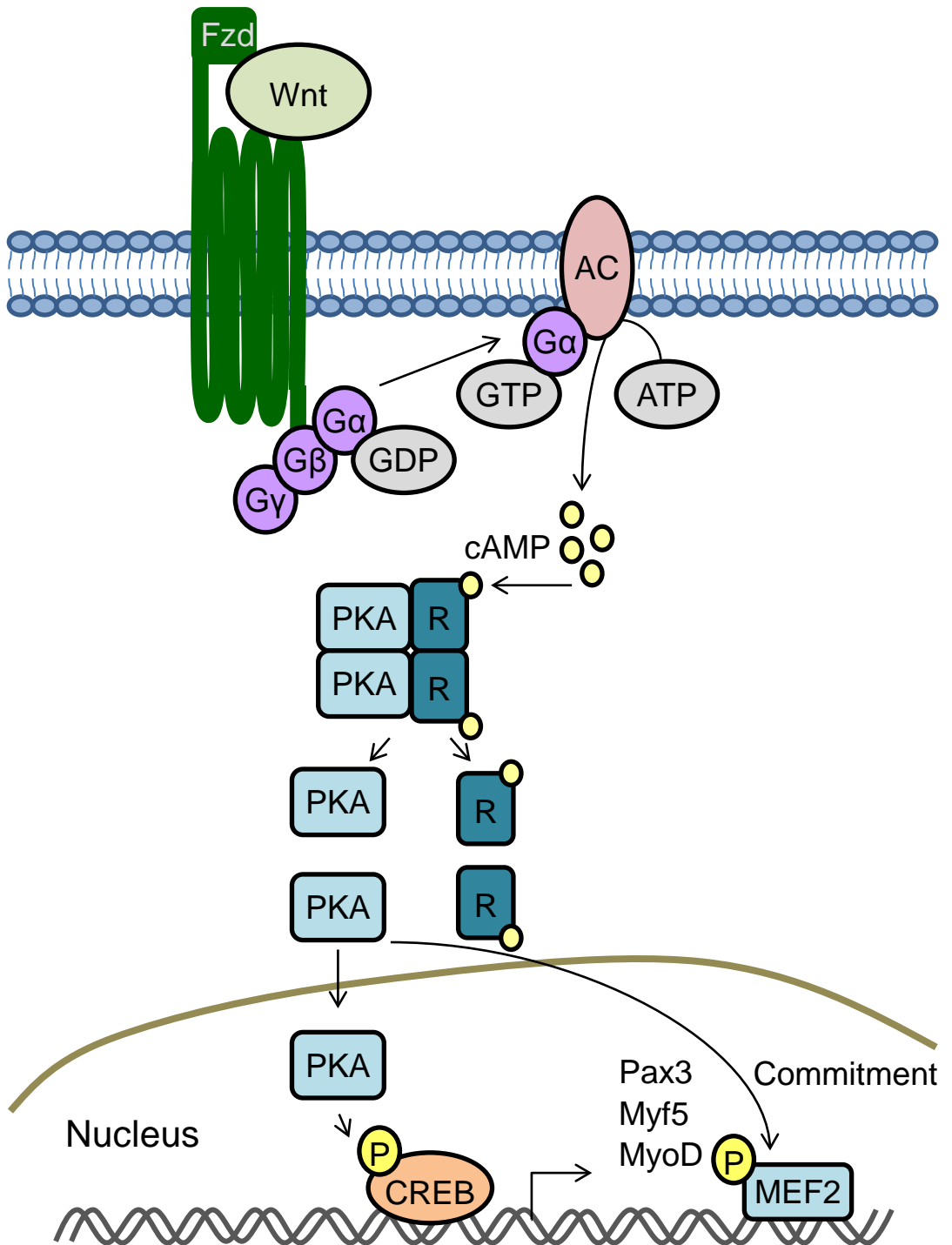

**Figure 9. Mechanism of Wnt signaling in mesodermal cells.**

Non-canonical Wnt signaling is involved in commitment to the myogenic lineage. Wnt 1 or 7a bind to the frizzled receptor and activate G-coupled receptor proteins. GTP is used to activate adenylate cyclase which converts ATP to cAMP. cAMP binds to the regulatory (R) subunit of PKA resulting in dissociation from the catalytic subunit. The catalytic subunit of PKA enters the nucleus and phosphorylates the transcription factor, CREB. CREB mediates transcription of Pax3 and the myogenic commitment genes, Myf5 and MyoD. The catalytic subunit of PKA can directly phosphorylate the MEF2D transcription factor which represses its activity.



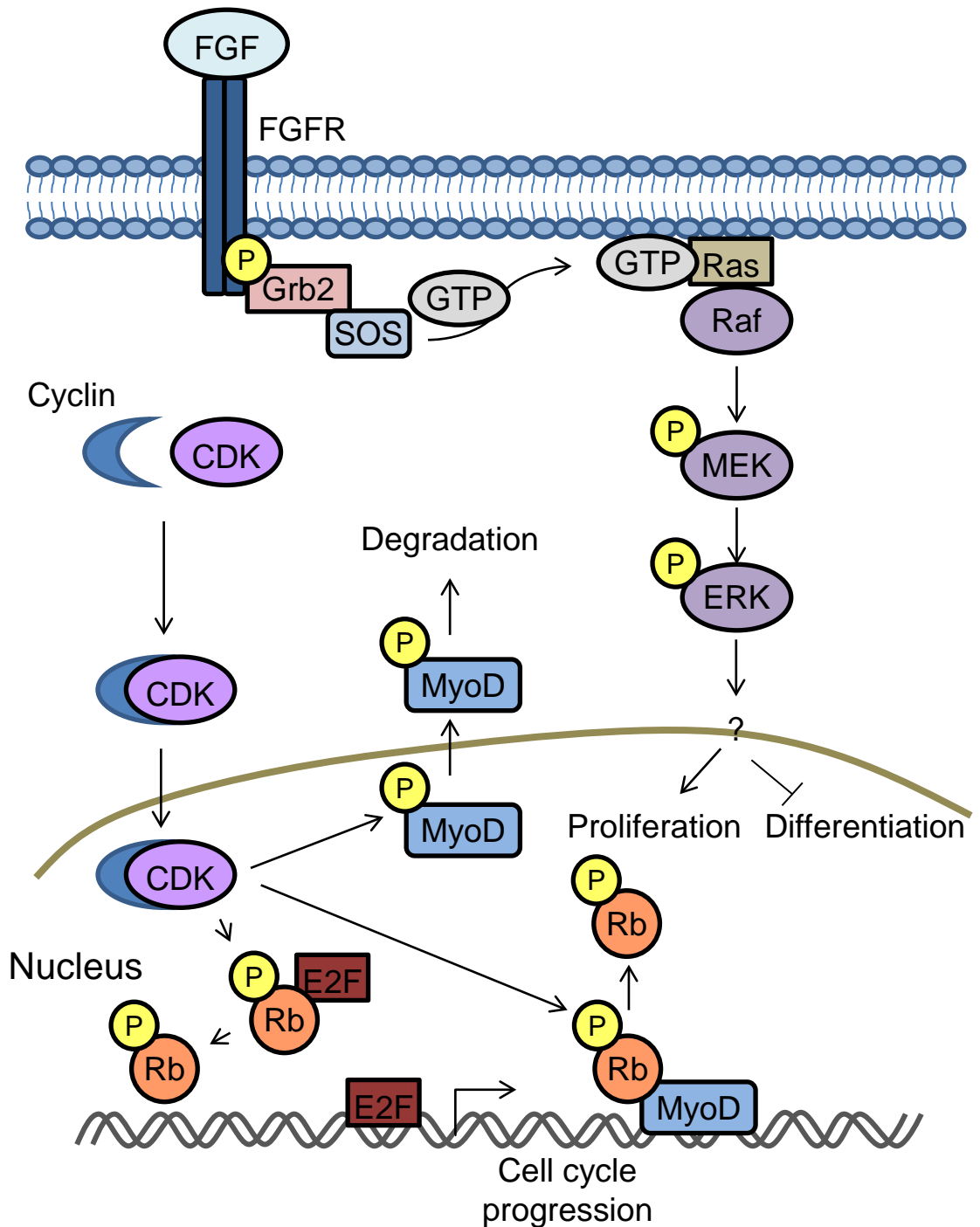

**Figure 10. Activation of proliferation and cell cycle progression in myoblasts by growth factors and cyclins.**

Fibroblast growth factor (FGF) activates the MEK 1/2-ERK 1/2 pathway. ERK 1/2 targets are not well understood but activation of this kinase promotes proliferation and inhibit differentiation in myoblasts. CyclinD/CKD4 and cyclinE/CDK 2 phosphorylate Rb, preventing interaction with E2F and MyoD. E2F can activate cell cycle progression genes while MyoD can not activate differentiation genes, thus promoting proliferation. CyclinE/CDK2 can also directly phosphorylate MyoD on S200, which targets it for protein degradation.

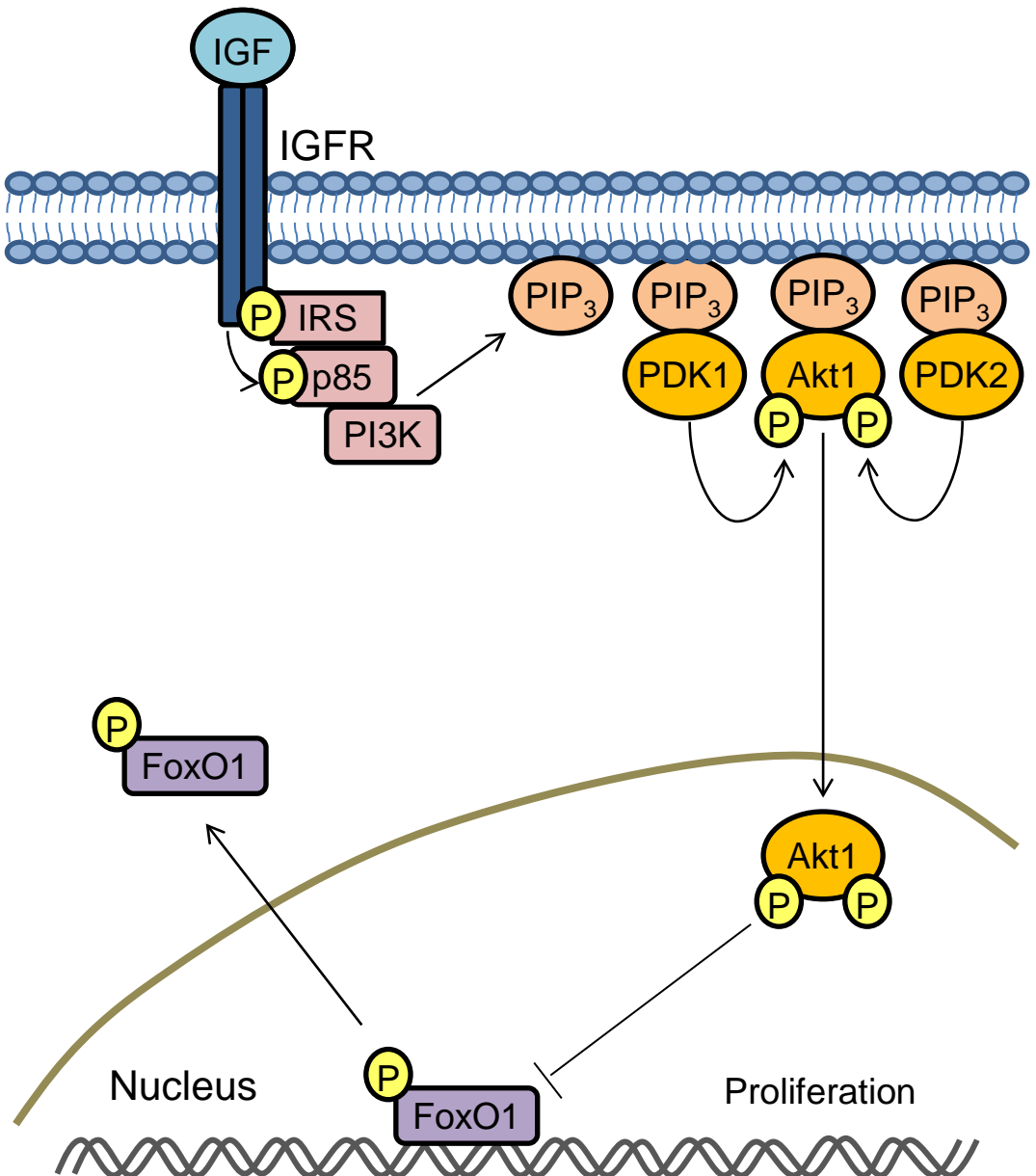

**Figure 11. IGF signaling in myogenesis inhibits differentiation.**

IGF binds to its receptor and activates the insulin receptor substrate (IRS) which recruits PI3K. PI3K is converted to PIP<sub>3</sub> which is involved in the phosphorylation of Akt1. Phosphorylated Akt2 enters the nucleus and phosphorylates the FoxO1 transcription factor. FoxO1 exits the nucleus and is degraded in the cytoplasm. FoxO1 can not activate the cell cycle inhibitor p27, thus, inhibiting differentiation.

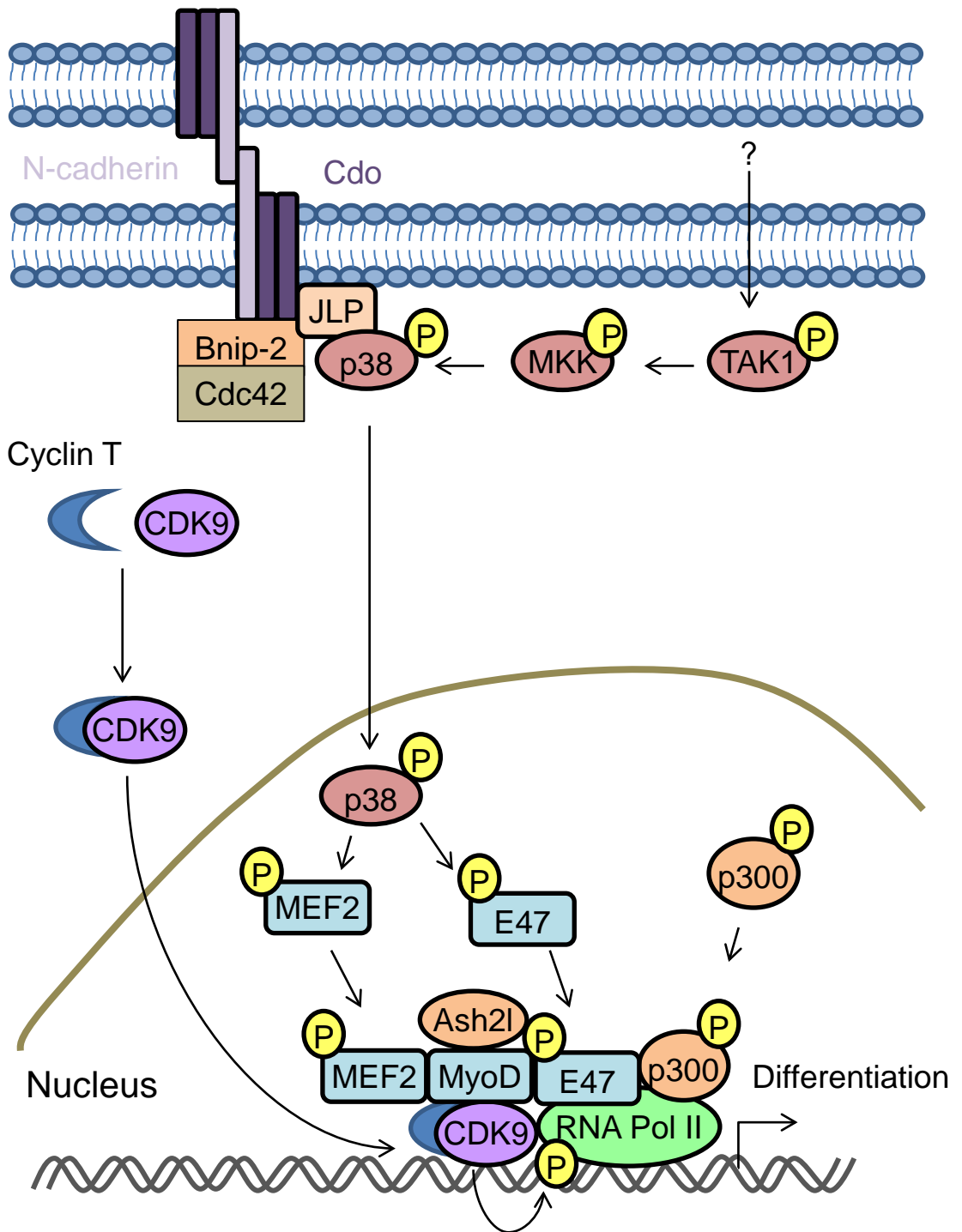

**Figure 12. Mechanism of p38 signaling in skeletal muscle differentiation.**

The extracellular signals that activate the MKK 3/6-p38 pathway are unknown. Cell to cell contact and activation of the Cdo receptor via N-Cadherin is one mechanism of activation of p38 signaling. p38 can phosphorylate and activate MEF2 and E47 proteins. MEF2, MyoD and E47 form a complex with RNA pol II, which is activated by phosphorylation by cyclinT/CDK9. This complex promotes activation of muscle differentiation genes.

## **Skeletal muscle regeneration**

### ***3.1 Characterization and identity of satellite cells***

Satellite cells are located between the basal lamina and the sarcolemma (plasma membrane) of muscle fibres and were initially observed in 1961 by use of electron microscopy. These cells were observed due to their atypical peripheral location in the muscle fibre (Mauro, 1961) (figure 13). Also noted were their large nuclei to cytoplasm ratio and condensed chromatin. Satellite cells are thought to originate from the dermomyotome and account for approximately 30% of the nuclei in postnatal muscle and decreases to roughly 5% in adult muscle. These cells are committed myogenic progenitor cells that are distinct from myoblasts. They are mitotically quiescent, but may enter multiple rounds of proliferation in response to injury to generate myoblasts or myogenic precursor cells, which will contribute to repair of the muscle fibre or generation of new fibres. In 1969, Reznik demonstrated that satellite cells contribute their nuclei to growing and damaged muscle fibres (Reznik, 1969). This observation was later corroborated by others (Bischoff, 1975). The regenerating potential of satellite cells was observed early, but research continues to unravel how they work.

Satellite cells are thought to originate during development. Satellite cells of the trunk originate in the dermomyotome determined by chick-quail grafting experiments (Gros et al., 2005). Limb muscle satellite cells are derived from hypaxial dermomyotome (Schienda et al., 2006). Satellite cells are composed of a heterogeneous group with differential expression of markers. All satellite cells express Pax7 while there is a decrease in Pax3 some express Pax3 at low levels as well as MyoD (Kuang et al., 2006). In response to injury, satellite cells become activated and

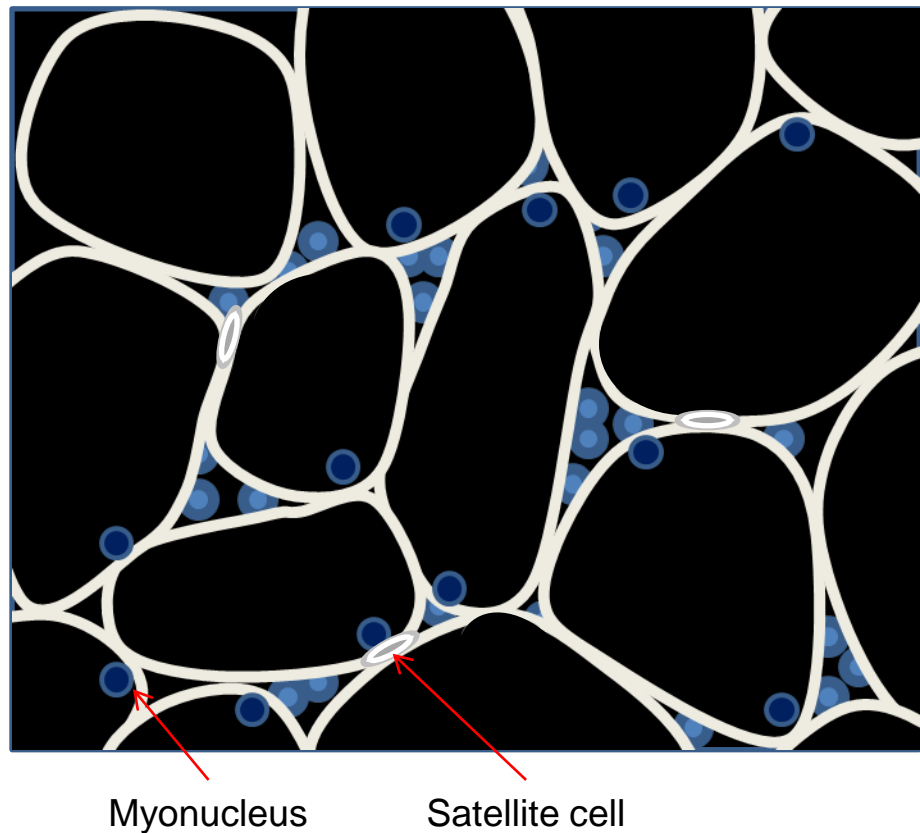
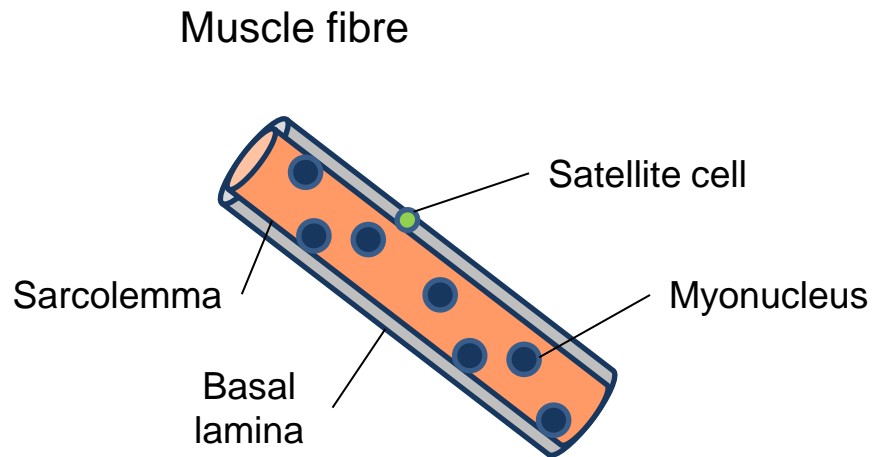

**Figure 13. Anatomical location of satellite cells in muscle fibre.**

In a single muscle fibre, satellite cells reside between the basal lamina and sarcolemma. Satellite cells are distinct from the myonuclei of the muscle fibre. In a cross section through a bundle of muscle fibres, the number of satellite cells are few and located on the periphery of fibres.

proliferate (figure 14). Daughter cells can either down regulate Pax7 and proceed to myogenic differentiation, or maintain Pax7 and remain quiescent and still have the ability to re-enter the cell cycle (Zammit et al., 2004). Satellite cell activation is controlled by Notch signaling. Notch is activated in satellite cells in transition from quiescent to activated or proliferative. An inhibitor of Notch signaling, Numb, is localized asymmetrically in dividing cells. In one cell it down regulates Notch mediated cell proliferation and these cells can differentiate (Conboy and Rando, 2002). Numb has become the marker for asymmetric satellite cell division. It was determined that Numb co-segregates with labelled DNA template into cell expressing Pax7 (Shinin et al., 2006). Two populations of satellite cells have been defined; one that are Pax7<sup>+</sup>Myf5<sup>+</sup> and one Pax7<sup>+</sup>Myf5<sup>-</sup>. Additionally it had been observed that Pax7<sup>+</sup>Myf5<sup>-</sup> cells give rise to Pax7<sup>+</sup>Myf5<sup>+</sup> and divide in a apical-basal manner (Kuang et al., 2007). In most apical-basal divisions, Pax7<sup>+</sup>Myf5<sup>-</sup> cells are on the basal surface, while that Pax7<sup>+</sup>Myf5<sup>+</sup> cells are on the apical side, which is adjacent to the muscle fibre (figure 14). Additionally, Pax7<sup>+</sup>Myf5<sup>-</sup> cells can contribute to satellite cell reserve when transplanted in Pax7<sup>-/-</sup> mice (Kuang et al., 2007) (figure 15).

### ***3.2 Molecular regulation of satellite cells***

Satellite cells express distinct molecular and surface markers. During quiescence, satellite cells express transcription factors such as Pax3, Pax7 and Myf5. Pax7 is a marker for quiescent and activated satellite cells. Membrane proteins such as M-Cadherin, CD34, c-Met, syndecan3/4 and nuclear envelope proteins laminin A and C are also expressed. It is thought that the adhesion marker N-cadherin allows the satellite cell to communicate with the adjacent myocyte (Irintchev et al., 1994). While

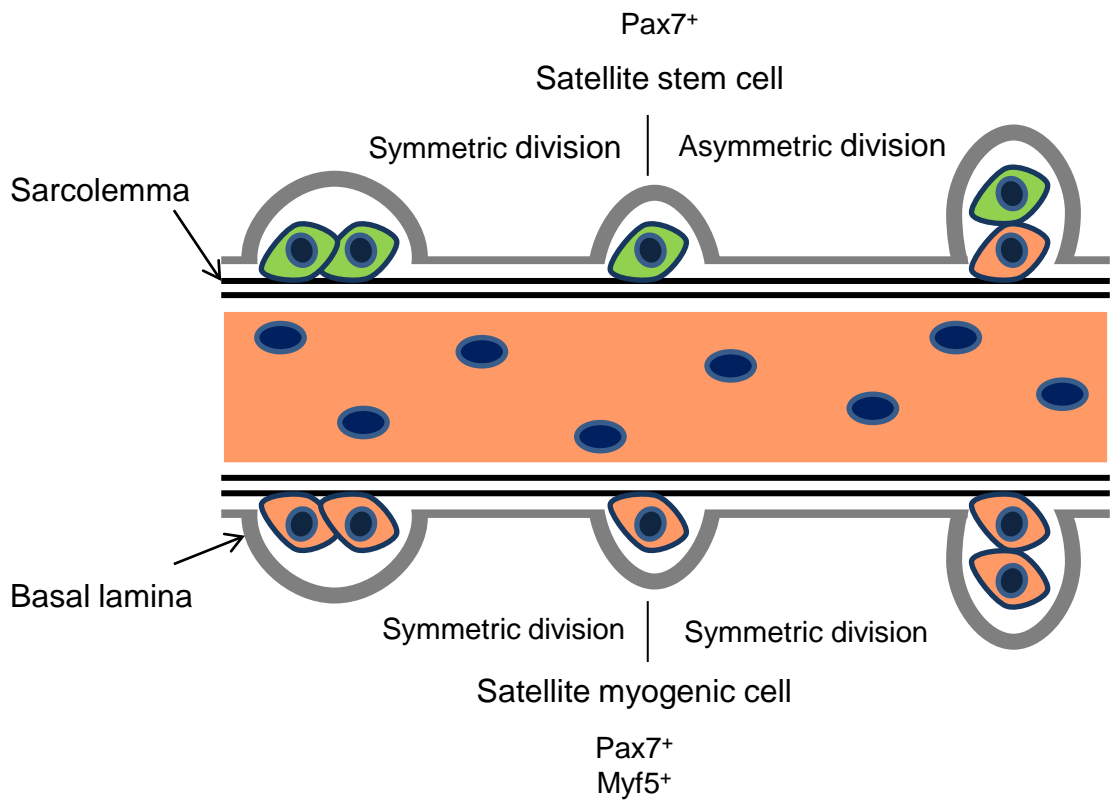

**Figure 14. Symmetric and asymmetric satellite cell division.**

Satellite cells can be divided into satellite myogenic cells (Pax7<sup>+</sup>, Myf5<sup>+</sup>) and satellite stem cells (Pax7<sup>+</sup>). Satellite myogenic cells (Pax7<sup>+</sup>, Myf5<sup>+</sup>) undergo symmetric division, producing other satellite myogenic cells (Pax7<sup>+</sup>, Myf5<sup>+</sup>), which can form new fibres or repair existing ones. Satellite stem cells (Pax7<sup>+</sup>) can self-renew by symmetric division or may generate satellite myogenic cells (Pax7<sup>+</sup>, Myf5<sup>+</sup>) by asymmetric cell division.

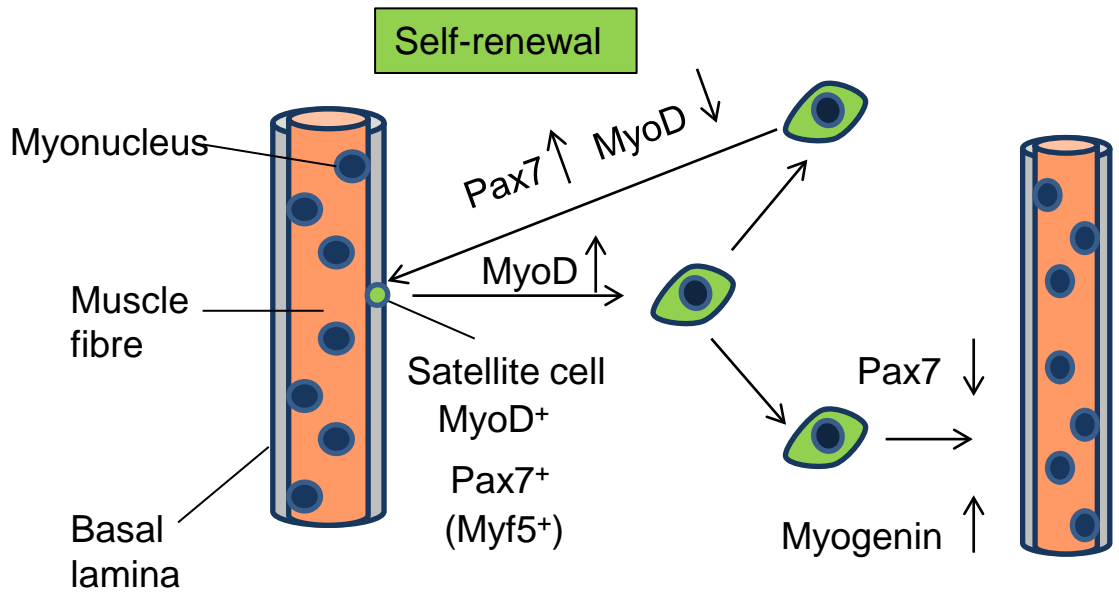

**Figure 15. Satellite cell activation and self-renewal.**

Quiescent satellite cells express Pax7 and Myf5. Once activated, satellite cells express MyoD, which activates Myogenin. Cells expressing Myogenin that are derived from satellite cells down regulate Pax7 and can form either a new fibre or contribute to an existing one. Activated satellite cells also self-renew, continuing to express Pax7.



Pax3 and Pax7 are involved in the activation of the myogenic program as they bind to and regulate elements in the *myod* gene. Following activation due to injury or damage satellite cells express Myf5 and MyoD which turns on Myogenin causing the myogenic program to be initiated resulting in repair of the fibre or generation of a new one. At the time of activation, satellite cells may also self-renew an attribute that allows classification of these cells as stem cells, since they display lineage specific differentiation and self-renewal (Buckingham and Montarras, 2008). Fate choices and balance between self-renewal and differentiation are characteristic of stem cells, and of satellite cells.

### ***3.3 Signaling mechanism in satellite cells***

Extracellular signaling pathways affect satellite cell self-renewal and differentiation, and involve the canonical and non-canonical Wnt signaling pathway (Otto et al., 2008) and the Notch pathway (Conboy and Rando, 2002; Mourikis et al., 2012). Activation of canonical Wnt signaling by Wnt 1a, 3a and 5a has been shown to increase satellite cell proliferation.  $\beta$ -catenin can increase Pax7<sup>+</sup> cells, thus inhibiting differentiation. Conversely, silencing of  $\beta$ -catenin decreases self renewal of satellite cells and increases their activation (Otto et al., 2008). While the non-canonical pathway activated by Wnt7a was found to determine satellite cell polarity activating symmetric expansion of satellite cells via planar cell polarity pathway (PCP) (figure 16) (Le Grand et al., 2009; von Maltzahn et al., 2012).

Notch signaling may play an important role in regeneration, as reduced Notch signaling leads to precocious differentiation of skeletal muscle progenitor cells promoting renewal of muscle progenitor cells (Buckingham and Vincent, 2009).

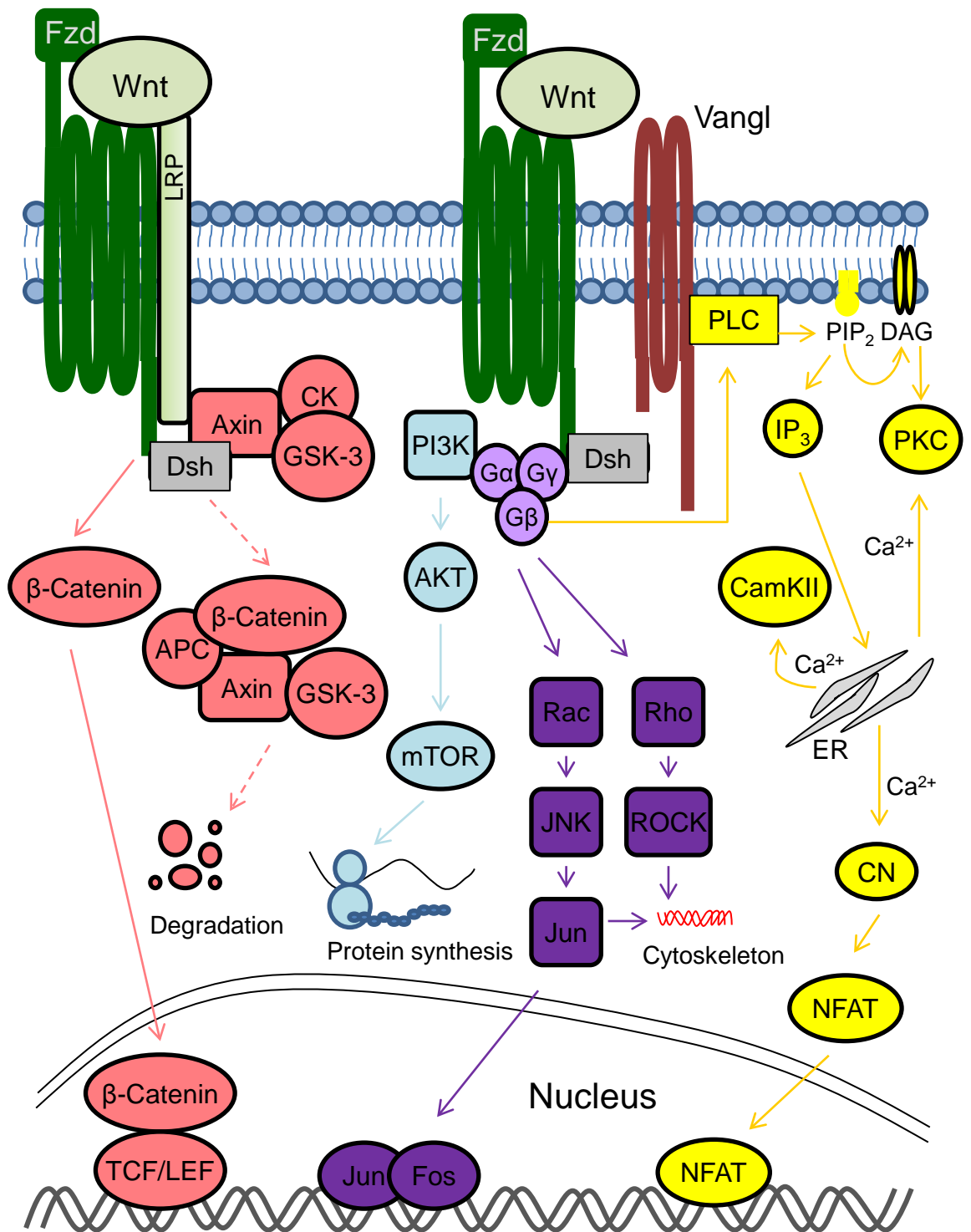

**Figure 16. The canonical and non-canonical Wnt signaling pathways in satellite cells.**

When phosphorylated by GSK3-β, β-Catenin is targeted for degradation. Wnt signaling mediates activation of Dishevelled (Dsh) which prevents GSK3-β from phosphorylating β-Catenin. β-Catenin can enter the nucleus and interact with TCF/LEF to activate Myf5. The non-canonical Wnt pathways involve activation of G-protein coupled receptors, which activate the PLC, JNK, ROCK, and Akt pathways. Activation of PLC increases extracellular calcium stimulating calcineurin (CN) to activate NFAT. The JNK and ROCK pathways mediate changes in cytoskeleton while 30 the Akt pathways promotes protein synthesis via mTOR.

Figure 8 illustrates the notch signaling pathway. The Notch intracellular domain (NICD) is cleaved and enters the nucleus where it interacts with CLS to turn on genes, such as Hes1, which repress myogenic genes. In addition, conditional knock outs of the Notch intracellular domain (NICD) interacting protein RBPJ (or CLS) results in precocious differentiation of skeletal muscle and a decrease in satellite cell number. Thus, suggesting that Notch signaling prevents premature differentiation of myogenic stem cells and progenitor cell during development. In contrast, Notch activation in adult satellite cells activated satellite cells and sustained Notch signaling inhibits satellite cell differentiation. Inhibition of cleavage of NICD by  $\gamma$ -secretase does not cause satellite cell activation as there is a reduced number of Pax7<sup>-</sup>, MyoD<sup>+</sup> cells (Mourikis et al., 2012). ERK1/2 signaling may be involved in regulating satellite cells. Pax7 is involved in satellite cell self renewal and Myostatin may regulate this by ERK 1/2 signaling (McFarlane et al., 2008).

### ***3.4 Non-skeletal muscle cell types with regenerative potential***

Satellite cells are the primary source of cells that regenerate skeletal muscle. However, other cells of mesodermal origin that are Pax7<sup>-</sup>, but reside in muscle may have myogenic potential. Pericytes (Dellavalle et al., 2011; Dellavalle et al., 2007), mesoangioblast and CD133<sup>+</sup> cells have been shown to give rise to myogenic cells. Side population (SP) cells were identified in bone marrow, but later found to be in muscle and can differentiate into adipocytes and osteogenic cells. Muscle side population (SP) cells are found within skeletal muscle and have similar markers to mesoangioblasts and muscle derived stem cells. They can contribute to muscle repair after injury and

vascular regeneration. The majority are CD31<sup>+</sup> and some are defined as CD31<sup>-</sup>, CD45<sup>-</sup> and this subset has been shown to contribute to new fibres post injury (Uezumi et al., 2006). Additionally, in transplantation experiments SP CD31<sup>-</sup>, CD45<sup>-</sup> enhanced myoblast proliferation in fibres (Motohashi et al., 2008). Muscle derived stem cells (MDSC) and myo-endothelial cells also have myogenic lineage potential. These multipotential progenitor cells are found outside or within muscle and have been shown to differentiate into skeletal muscle. A subset of interstitial cells called PW1<sup>+</sup> interstitial cells (PICs) express PW1, which is also expressed in satellite cells (Mitchell et al., 2010; Pannerec et al., 2013). Although PW1 is expressed in satellite cells and interstitial cells, PICs express genes similar to mesenchymal stem cells and have the potential to become smooth, skeletal muscle and fat (Pannerec et al., 2013).

### **Models used to investigate skeletal myogenesis**

A variety of model systems have been exploited in order to unravel the phenotypic and molecular events that define the differentiation program in skeletal muscle. The chick and quail embryos have been one of the primary animal model systems used as well as the mouse, *Drosophila*, and zebra fish model systems. The C2C12 cell line is the most widely accepted ex-vivo model for differentiation while the rat L6 skeletal muscle cell line is also used but does not express Myf5. Preparation of primary myoblast cultures from skeletal muscle as well as isolation of primary single fibres are well established and have been useful in continuing skeletal muscle research.

#### ***4.1 The C2C12 cell line***

The C2C12 mouse myoblast cell line is a subclone of the C2 myoblast line derived from a satellite cell and originally made by Yaffe et al, has been the classic cell culture model to study myogenic differentiation outside of the animal and has provided a useful model for elucidating skeletal myogenesis (Yaffe and Saxel, 1977).

Mononucleated myoblasts can be cultured in high serum conditions (10% FBS in DMEM) where they are highly proliferative and then can be induced to differentiate upon serum withdrawal (2% HS in DMEM) and cell-to-cell contact. In low serum conditions and about 70% density, myoblasts withdraw from the cell cycle, align, fuse and form multinucleated myotubes (figure 17). Thus, the C2C12 cell culture system has proven useful in effectively recapitulating the myogenic process *ex-vivo*. Consequently, use of C2C12 cells has allowed for investigation of the processes that constitute myogenesis, namely the MRFs, and the factors regulating them. Interestingly, mononucleated cells that coexist in differentiated cultures of myotubes have been observed. These quiescent cells, termed reserve cells do not express myogenic differentiation markers and may be similar to satellite cells (Yoshida et al., 1998).

#### ***4.2 Primary single fibre cultures***

Skeletal muscle fibres have been isolated for over 25 years (Bischoff, 1986; Rosenblatt et al., 1995) and this method has continued to be altered and enhanced (Anderson et al., 2012; Pasut et al., 2013). Single fibres from a variety of skeletal muscle such as the tibialis anterior (TA) and the more widely used extensor digitorum longus (EDL) can be dissected from mice and studied in culture (Pasut et al., 2013). Isolation of single muscle fibres allow for manipulation of satellite cells in culture.

## C2C12 cell model

### Proliferation

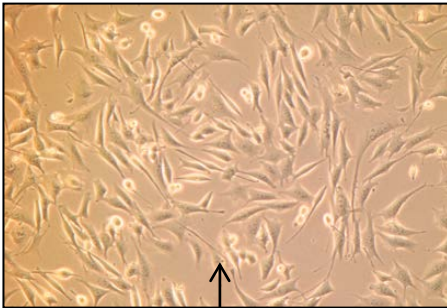

MB

### Differentiation

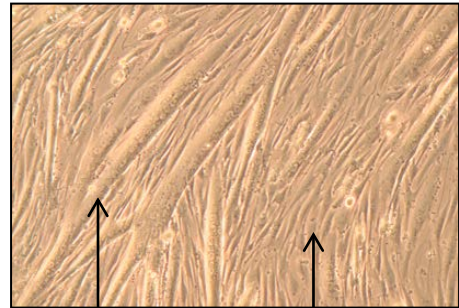

MT

Reserve cell

## Primary single fibre

### Pax7

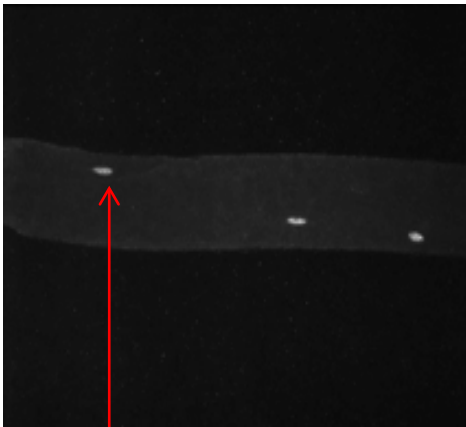

Satellite cell

### DAPI



Myonucleus

### Figure 17. Culture models for skeletal muscle.

In the C2C12 cell model, myoblasts (MB) proliferate in high serum conditions. In differentiation conditions (low serum and cell contact), MB form multinucleated myotubes (MT). In a differentiated culture, multinucleated MT and quiescent mononucleated cells, called reserve cells, coexist. In primary single myofiber cultures, the fiber contains many myonuclei, indicated by DAPI staining. Satellite cells, indicated by Pax7 immunofluorescence expression, are located on the periphery of the muscle fiber.

This model does not replace *in vivo* models, but does provide a useful tool for investigating satellite cells in their natural niche in an intact muscle fibre. Fluorescence microscopy is routinely used for identifying satellite cells that are Pax7<sup>+</sup> (figure 17) on single muscle fibres and fluorescence activated cell sorting (FACS) can be used to isolate large amounts of Pax7 positive satellite cells.

### **The Activator Protein-1 transcription factor complex**

These ubiquitously expressed transcription factors are involved in a great variety of cellular processes. AP-1 are classical oncogene that have roles in proliferation (Shaulian and Karin, 2001) and tumourgenesis (Shaulian and Karin, 2002), but have other regulatory functions. Although its' members functions may seem redundant, they have specific development functions.

#### ***5.1 Structural, physical and biological properties***

Activator protein-1 (AP-1) is a transcription factor complex consisting of immediately early gene products of the Jun and Fos families (figure 18) (Angel and Karin, 1991). AP-1 components belong to the basic leucine zipper (b-ZIP) family of transcription factors, which also include members of activating transcription factor (ATF), musculoaponeurotic fibrosarcoma (Maf) and CREB binding protein (C/EPB) (Chinenov and Kerppola, 2001). Proteins that comprise the Jun family include c-Jun, JunB and JunD and may form homodimers with its members or heterodimers with members of the Fos family (Halazonetis et al., 1988; Milde-Langosch, 2005; Smeal et al., 1989). Members of the Fos family of proteins are c-Fos, FosB, Fra-1 and Fra-2, which can only heterodimerize with Jun proteins (Milde-Langosch, 2005; Smeal et al.,

1989). Heterodimerization with Fos members increases Jun activity more than binding with other Jun proteins (Allegretto et al., 1990). Dimerization occurs via hydrophobic interactions of leucine residues in the leucine zipper domain (Angel and Karin, 1991). The AP-1 complex was found to be induced by TPA (12-*O*-tetradecanolyphorbol 13-acetate) allowing binding to the TPA responsive element (TRE) (Angel et al., 1987; Lamph et al., 1988), which is identified by its 5' TGAC/GTCA 3' consensus sequence found in promoter and enhancer regions of many genes (Angel and Karin, 1991; Angel et al., 2001; Lee et al., 1987b; Milde-Langosch, 2005). AP-1 components may also interact with other b-ZIP members and weakly bind cAMP response element (CRE), which is recognized by 5' TGACGTCA 3' (Chinenov and Kerppola, 2001). Of the first promoters that AP-1 was found to interact with were human metallothionein IIa promoter and simian virus 40 (SV40) (Lee et al., 1987a), thus AP-1 was found to regulate both cellular and viral genes. Activation occurs in response to growth factors, cytokines, stress and oncogenic stimuli. Classically, AP-1 was primarily implicated in proliferation and tumourgenesis, however, ongoing research has expanded its role determining that AP-1 proteins are ubiquitously expressed and regulate gene expression and modulate a variety of cellular functions in addition to cell proliferation such as differentiation, apoptosis inflammation, cell migration and wound healing (Shaulian and Karin, 2001).



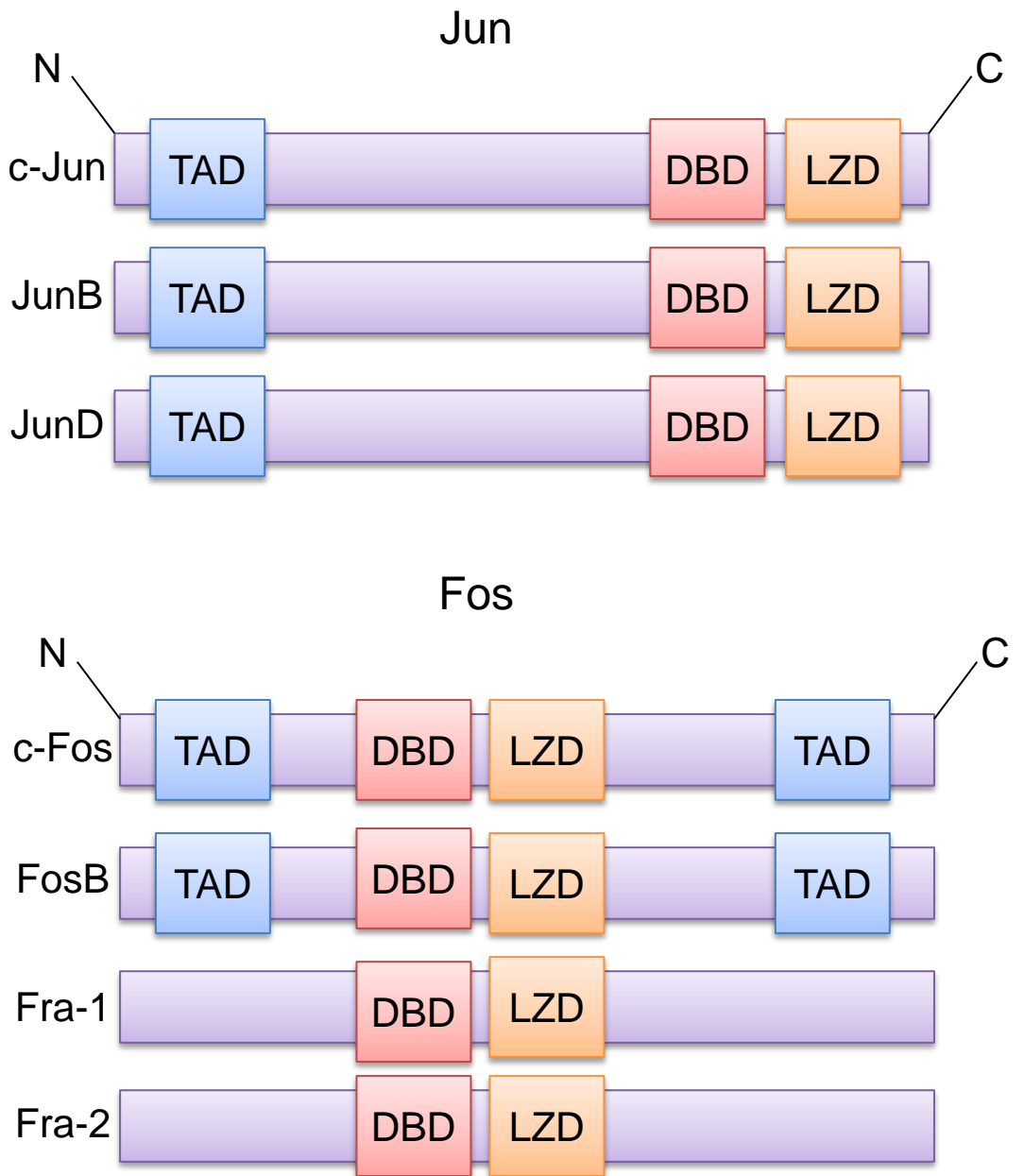

**Figure 18. Comparison of functional domains in AP-1 family members.** AP-1 transcription factors form a complex of JUN homodimers or JUN-Fos heterodimers. All AP-1 proteins, except Fra-1 and Fra-2, contain a transactivation domain (TAD) that mediates gene expression. The AP-1 proteins have a DNA binding domain (DBD) and a leucine zipper domain (LZD) used for dimerization.

## ***5.2 The Jun and Fos family of transcription factors***

The c-Jun (or Jun) and c-Fos (or Fos) transcription factors are one of the most well characterized AP-1 proteins of its members and has roles in cell proliferation and transformation. C-Jun is the most patented activator of transcription. A protein, v-Jun, was isolated from the Avian sarcoma virus 17 (Maki et al., 1987), whose sequence was found to have similar DNA binding domains to the yeast transcription factor GCN4 leading to the identification of c-Jun as they recognize the same sequence on DNA (Bohmann et al., 1987; Vogt et al., 1987). The cellular version of Fos was also identified based on similarity to its viral counterpart found in the Finkel-Biskis\_Jinkins (FBJ) murine sarcoma virus (van Straaten et al., 1983). Some AP-1 proteins have transformation potential, for example, c-Jun has the ability to transform cells in conjunction Ras (Johnson et al., 1996; Vandel et al., 1996). Similarly, c-fos can also transform cells, but its mechanism involves activating DNA methyl transferase1 (DNMT1) leading to derepression of genes (Bakin and Curran, 1999). The C terminal domain of Fos is required for transformation (Wisdon and Verma, 1993). Of the AP-1 proteins, c-Jun has the highest transcription activity especially in combination with c-Fos (Ryseck and Bravo, 1991). Interestingly, it was observed that when JunB dimerizes with c-Jun it can repress c-Jun activity (Schutte et al., 1989) and was later demonstrated using the cyclinD1 promoter, a known target of c-Jun (Bakiri et al., 2000; Carter et al., 1991). Further studies have determined that members of the Jun and Fos family work together in regulating cell cycle progression (Kovary and Bravo, 1991). Biological roles for c-Jun and c-Fos are proposed based on transgenic and mutational analyses. The c-Jun transgenic mouse does not display overt developmental abnormalities phenotype.

In contrast, the knockout is embryonic lethal at E12.5 and has liver and heart defects (Eferl et al., 1999). Additionally, it was found that cells lacking c-Jun had declined proliferation and reduced expression of cyclinD1 (Johnson et al., 1993) that corroborated its role as a mediator of proliferation. The c-fos transgenic mouse has an osteoblast phenotype and develops osteosarcoma (Grigoriadis et al., 1993), while the knockout mouse affects osteoclasts and develops osteopenia (Wang et al., 1992).

### **5.3 *JunB***

JunB is essential for embryonic development as mice lacking JunB do not survive post E 8.5-10 due to placental defects (Schorpp-Kistner et al., 1999). JunB may also have a role in bone development as the conditional transgenic mice have bone defects (Kenner et al., 2004). In cell cycle progression, unlike c-Jun, JunB is proposed to be an inhibitor of cell proliferation. JunB levels are decreased in quiescent cells, but become elevated in G<sub>0</sub> to G<sub>1</sub> transition and to S phase, while lowering in G<sub>2</sub> to M. JunB is anti-proliferative, since it induces expression of the CKI, p16 and inhibits cyclinD (Passegue and Wagner, 2000). Although, JunB opposes c-Jun's pro-proliferation role it has been shown to be required for osteoblast proliferation in JunB conditional gene targeted mice (Kenner et al., 2004).

### **5.4 *JunD***

JunD is not required for embryogenesis as the gene targeted mice are viable, but postnatal growth is declined (Thepot et al., 2000). More interestingly, male animals lacking JunD had reproductive abnormalities and are sterile, but females were not affected suggesting JunD is required for male appropriate reproduction (Thepot et al.,

2000). There are two isoforms of JunD, the full length which is 39 kDa and a truncated form that is 34 kDa lacking part of the N-terminus (Okazaki et al., 1998). JunD may also have a role in bone formation as it interacts with multiple endocrine neoplasia type 1 (MEN1), which is involved in bone differentiation (Naito et al., 2005). Interestingly, JunD, as opposed to c-Jun, can inhibit transformation by Ras (Pfarr et al., 1994).

### **5.5 *FosB***

FosB is a 338 amino acid protein with a characterized transcription activation domain it has spliced variant delta FosB2. FosB has transforming potential, which is dependent on the C terminal domain (Wisdon and Verma, 1993). Interestingly, FosB transgenic mice do not have an overt phenotype nor does its knockout counterpart.

FosB is largely associated with behavioural effects. For example, gene targeting mice acquire nurturing behaviour defects (Brown et al., 1996).

### **5.6 *Fos like antigen-1***

Fra-1 is a 245 amino acid protein that functions as a transcription factor but has low transactivation potential as it has no transactivation domain and inability to transform cells (Wisdon and Verma, 1993). The model of Fra-1 null mouse is embryonic lethal on account of placental defects (Schreiber et al., 2000). To examine the role of Fra-1 during development, a conditional knockout model was generated by Eferl et al., (2004), where they found that loss of Fra-1 resulted in low bone mass such as in an osteopenia phenotype (Eferl et al., 2004). The opposite effect of increase bone mass was observed in Fra-1 transgenic mice (Roschger et al., 2004).

## 5.7 Fos-like-antigen 2

Fra-2 was isolated by Nishina *et al.*, (1990) based on its ability to be recognized by antiserum raised against a Fos peptide (Nishina *et al.*, 1990). Fra-2 shares sequence homology to the other Fos proteins (Fra-1, FosB and c-Fos) and has been considered a proto-oncogene, since over-expression of Fra-2 transforms chicken embryo fibroblasts (Nishina *et al.*, 1990). In addition, it is demonstrated that Fra-2 forms stable dimers with c-Jun (Angel *et al.*, 2001). Extensive characterization of the *fra-2* gene and its promoter regions has provided insight into regulation of Fra-2 expression when induced by serum (Nishina *et al.*, 1990; Sonobe *et al.*, 1995). Studies have found that post translational modifications (PTMs) of Fra-2 induced by serum are regulated by ERK 1/2 and causes phosphorylation of Fra-2 (Sonobe *et al.*, 1995; Yoshida *et al.*, 1991). In order to map Fra-2 phosphorylation Murakami *et al.* (1999) constructed Fra-2 deletion mutations that were fused to GST at the amino terminal domain (Murakami *et al.*, 1999). In a series of *in vitro* kinase assays they found that subsequent to serum stimulation, Fra-2 was highly phosphorylated at its carboxyl terminal domain (Murakami *et al.*, 1999). Use of mutants with mutations at serine and threonine residues allowed them to conclude that threonine was the primary amino acid targeted for phosphorylation (Murakami *et al.*, 1997; Murakami *et al.*, 1999). Phosphorylation of Fra-2 in C2C12 cells is most likely due to its known upstream target ERK 1/2, which is also active during myoblast proliferation and in late stages of muscle differentiation (Sarbasov *et al.*, 1997). Studies have observed slower migrating Fra-2 bands by Western blot analysis and have attributed these changes to phosphorylation since the motility of these bands change when Fra-2 is immunoprecipitated and treated with calf

intestinal phosphatase (Illario et al.) (Alli et al., 2013; Andreucci et al., 2002; Murakami et al., 1997). A similar effect on Fra-2 banding pattern is observed upon the addition of a MEK 1/2 specific inhibitor (PD 98059 or UO126) (Alli et al., 2013; Cook et al., 1999). More recently S320 was found to be an ERK 1/2 specific phosphorylation site on Fra-2 that mediates its protein stability (Alli et al., 2013).

Abnormal muscle phenotypes have not been reported in Fra-2 transgenic or knockout mice. Fra-2 transgenic mice have abnormal eye development (McHenry et al., 1998) and in a separate study it was also reported that they had pulmonary fibrosis (Eferl et al., 2008). Fra-2 knockouts have alteration in chondrocytes and osteoclasts (Bozec et al., 2010). Fra-2 knockout mice are born and die within one week of birth (Eferl et al., 2007). Interesting it has been reported that they do not grow after birth compared to wild-type mice, thus, lacking postnatal development.

### ***5.8 Regulation by MAPK***

It has been demonstrated that AP-1 proteins are downstream targets of MAPK signaling when activated by extracellular factors (Cook et al., 1999; Eriksson and Leppa, 2002; McBride et al., 1993). Serum and growth factors activate the ERK 1/2 MAPK pathway, while pro-inflammatory cytokines and stress activated p38 and JNK pathways. The ERK 1/2 MAPK pathway targets Fos family members. The c-fos promoter contains an element termed the serum response element (SRE) when induced by serum or growth factors allows serum response factor (SRF) to complex with ternary complex factor (TCF) and bind to SRE (Hill et al., 1994). Fra-1 and Fra-2 are also targeted by ERK 1/2 MAPK pathway when induced by serum (Gruda et al., 1994). Interestingly, Fos, Fra-1 and Fra-2 share similar C termini and a conserved serine

residue that is targeted by phosphorylation by ERK 1/2 (figure 19) (Basbous et al., 2008), which has been corroborated in further studies and attributed to protein stability (Alli et al., 2013).

The p38 and JNK pathways target Jun proteins. The Jun N-terminal kinase (JNK) was found to phosphorylate c-Jun at S63 and S73 in its activation domain to enhance transcriptional activity (Derijard et al., 1994; Hibi et al., 1993). Additionally, JNK can phosphorylate ATF allowing it to interact with c-Jun and autoregulate itself (Gupta et al., 1995). JunB phosphorylation by JNK is unclear but it has been reported that Thr102 and Thr104 are target sites (Li et al., 1999). JNK also targets JunD at S90, S100 and Thr117 which enhances its transcriptional activity (Yazgan and Pfarr, 2002). The p38 MAPK does not directly phosphorylate Jun protein, but does phosphorylate transcription factors such as MEF2C which may regulate the c-Jun promoter (Gordon et al., 2009; Han et al., 1997). Also, p38 can phosphorylate ATF2 leading to the dimerization with c-Jun and regulation of the c-Jun promoter (Morooka et al., 1995).

### ***5.9 Activator Protein-1 and Myogenesis***

Skeletal muscle regulation by AP-1 has been investigated by several groups that determined that AP-1 has an overall negative role in differentiation (Andreucci et al., 2002; Bengal et al., 1992; Lehtinen et al., 1996; Pedraza-Alva et al., 1994; Thinakaran et al., 1993; Trouche et al., 1993). The inhibitory role of AP-1 can be partially attributed to overexpression experiments with either c-Jun or c-Fos that resulted in potent inhibition of myogenesis as these proteins can repress DNA binding of MyoD (McBride et al., 1993; Trouche et al., 1993). Additionally, c-Jun was found to physically interact with MyoD antagonizing its ability to activate E-box dependent gene

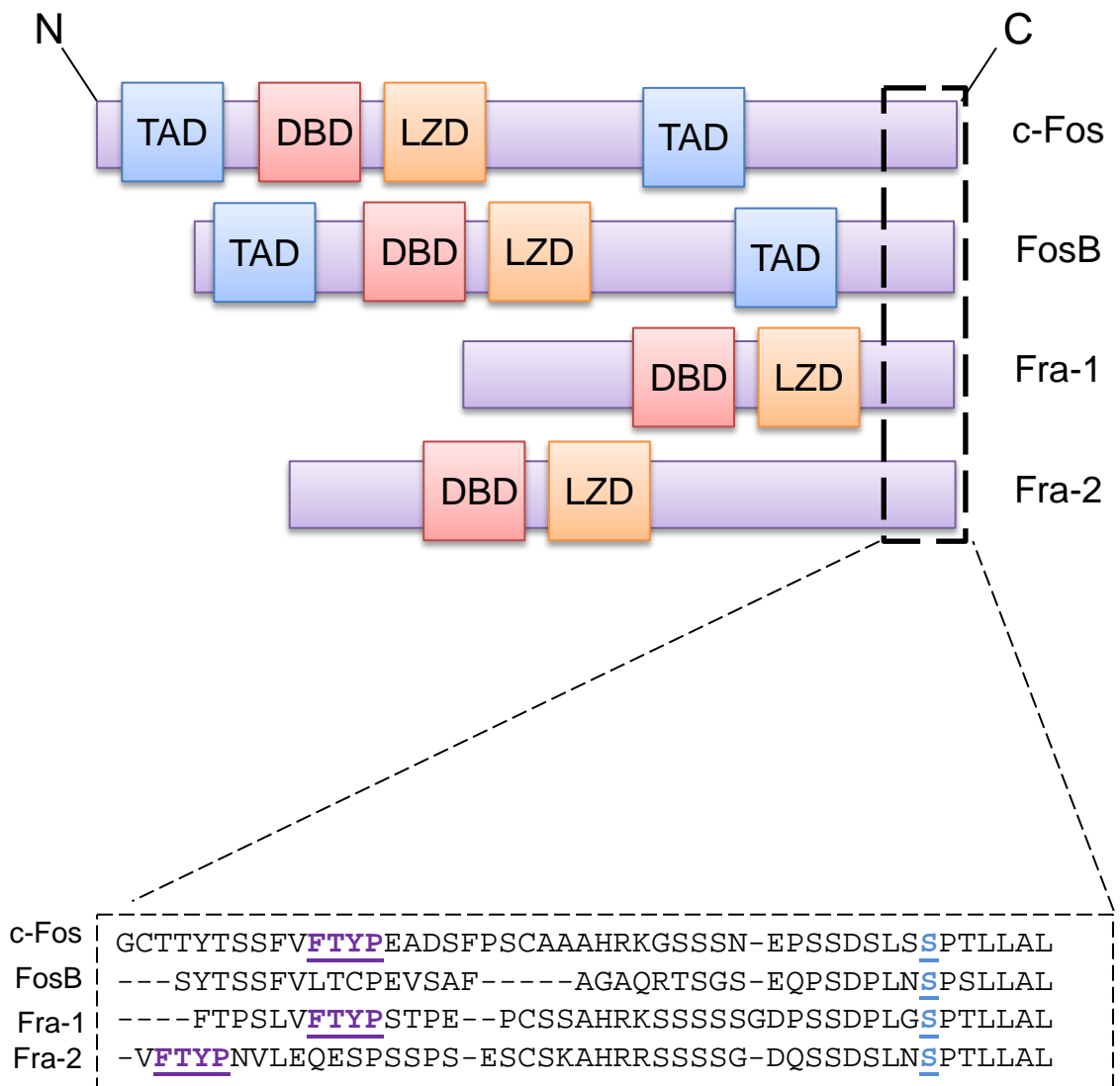

**Figure 19. Comparison of the C terminal domain of Fos family members.** All Fos proteins have a DNA binding domain (DBD) and a leucine zipper domain (LZD) for dimerization. C-Fos and FosB have transactivation domains (TAD) while Fra-1 and Fra-2 do not. A conserved MAPK phosphorylation site, SP, is found in all Fos members. The ERK 1/2 docking site is defined by the FTYP sequence and is found in c-Fos, Fra-1 and Fra-2.



expression enforcing that AP-1 negatively regulated myogenesis (Bengal et al., 1992). In contrast, MyoD was determined to down-regulate the c-Fos promoter in differentiation conditions (Trouche et al., 1993). However, these studies were largely focused on c-Jun and c-Fos and did not consider the other Jun and Fos proteins, thus overlooking the complexity of AP-1 dimer permutations in regulation of gene expression. Subsequent studies have also implicated AP-1 in regulating myogenesis, but suggest that its function during differentiation is more complex than has been previously reported (Andreucci et al., 2002). Electrophoretic mobility shift assays (Semsarian et al.) have shown that AP-1 has DNA binding activity in differentiating C2C12 cells and antibody supershifts reveal that c-Fos:c-Jun dimers are dominant in myoblasts, while Fra-2 is the primary dimerization partner with either c-Jun or JunD in differentiating myoblasts (Andreucci et al., 2002). C-Jun and c-Fos are known regulators of cyclinD1 and regulate proliferation of myoblasts. The c-Jun dimerization protein JDP2 was shown to repress proliferation in C2C12 cells (Ostrovsky et al., 2002). These data propose that other AP-1 members, specifically Fra-2 and JunD may have a role in myogenesis and AP-1 may directly regulate muscle specific gene expression in skeletal muscle. Also, regulation of Fra-2 may occur via phosphorylation as already demonstrated with c-Jun, c-fos and Fra-1 (Whitmarsh and Davis, 1996). Furthermore, the Fra-2 containing AP-1 complexes in skeletal muscle are transcriptionally active because they can modulate the MyoD enhancer/promoter in luciferase reporter assays (Andreucci et al., 2002).

An AP-1 target gene of interest in skeletal muscle is Vimentin. Vimentin is part of the intermediate filaments IF's family of protein and is cytosolic. TGF- $\beta$  induces

vimentin expression as well as phorbol esters (Carey and Zehner, 1995), both of which induce TRE dependent gene expression. AP-1 was found to mediate vimentin expression when activated by serum (Rittling et al., 1989) and more recently, it was found that AP-1 was required for TGF- $\beta$  mediated activation of the vimentin gene in skeletal muscle (Wu et al., 2007).

More recently, AP-1 expression was observed in reserve and satellite cells of skeletal muscle suggesting a role in regeneration and muscle maintenance (Alli et al., 2013). High throughput studies have extended studies into gene targets in skeletal muscle. A MyoD ChIP-seq by Cao et al., (2010) identified promoters bound by MyoD that were also associated with histone acetylation (Cao et al., 2010). Additionally, many of the MyoD targets were enriched with AP-1 binding sites (Cao et al., 2010). One MyoD target gene enriched for TREs was *mustn1*. It was demonstrated that AP-1 proteins bind to the *mustn1* promoter in a region close to the identified MyoD binding site (Liu and Hadjiargyrou, 2006). The Musculoskeletal temporally activated novel gene (Mustang) was discovered in a callus fracture screen and was later found to be required for chondrogenesis (Gersch and Hadjiargyrou, 2009). It is expressed in mesenchymal cells of the somite during development and becomes more restricted in adult tissues. In the adult, Mustang was only expressed in skeletal muscle and tendon (Lombardo et al., 2004). Loss of function studies utilizing siRNAs against *mustn1* in skeletal muscle demonstrated that there was inhibition of differentiation in C2C12 cells (Liu et al., 2010). Recently, *mustn1* was implicated in muscle regeneration and satellite cell activation as determined by a *mustn1*-GFP reporter mouse (Krause et al., 2013). Taken together, Mustang is a potential candidate target gene in skeletal muscle and an

AP-1 target. Therefore, the mechanism by which AP-1 is involved in satellite cell regulation may involve Mustang.

### **Mitogen activated protein kinases pathways**

Post-translational regulation of transcription factors is an important level control and includes protein: protein interactions and PTMs including phosphorylation, acetylation, methylation, ubiquitylation, glycosylation, and sumoylation. In addition to genetic regulation by various cell signals, transcription factors may be modified by mitogen activated protein kinase (MAPK) pathways (Johnson et al., 2006). There are many MAPK pathways, the most well characterized include the extracellular regulated kinase (ERK) 1/2, the c-Jun N-terminal kinase (JNK) and the p38 pathways (figure 20) (Cabane et al., 2003; Keren et al., 2006; Sarbassov et al., 1997).

#### ***6.1 Mechanism of signal transduction***

Extracellular stimuli in the form of growth factors, cytokines or stress interact with transmembrane receptors resulting in the activation of the receptor and transduction of the signal. ERK 1/2 signaling is initiated with receptor tyrosine kinases dimerization and autophosphorylation at Tyr residues in the cytoplasmic domain occur in response to ligand binding. Phosphorylation at Tyr in the receptor serve as sites of interaction for src homology 2 (SH2) domain proteins and phosphotyrosine binding (PTB) domain proteins (Whitmarsh and Davis, 1996). Both SH2 domain proteins and PTB domain proteins can interact with adaptor proteins that binds Ras, a small GTP binding protein. Ras activates Raf which is a MAPK kinase kinase which can phosphorylate MAPK

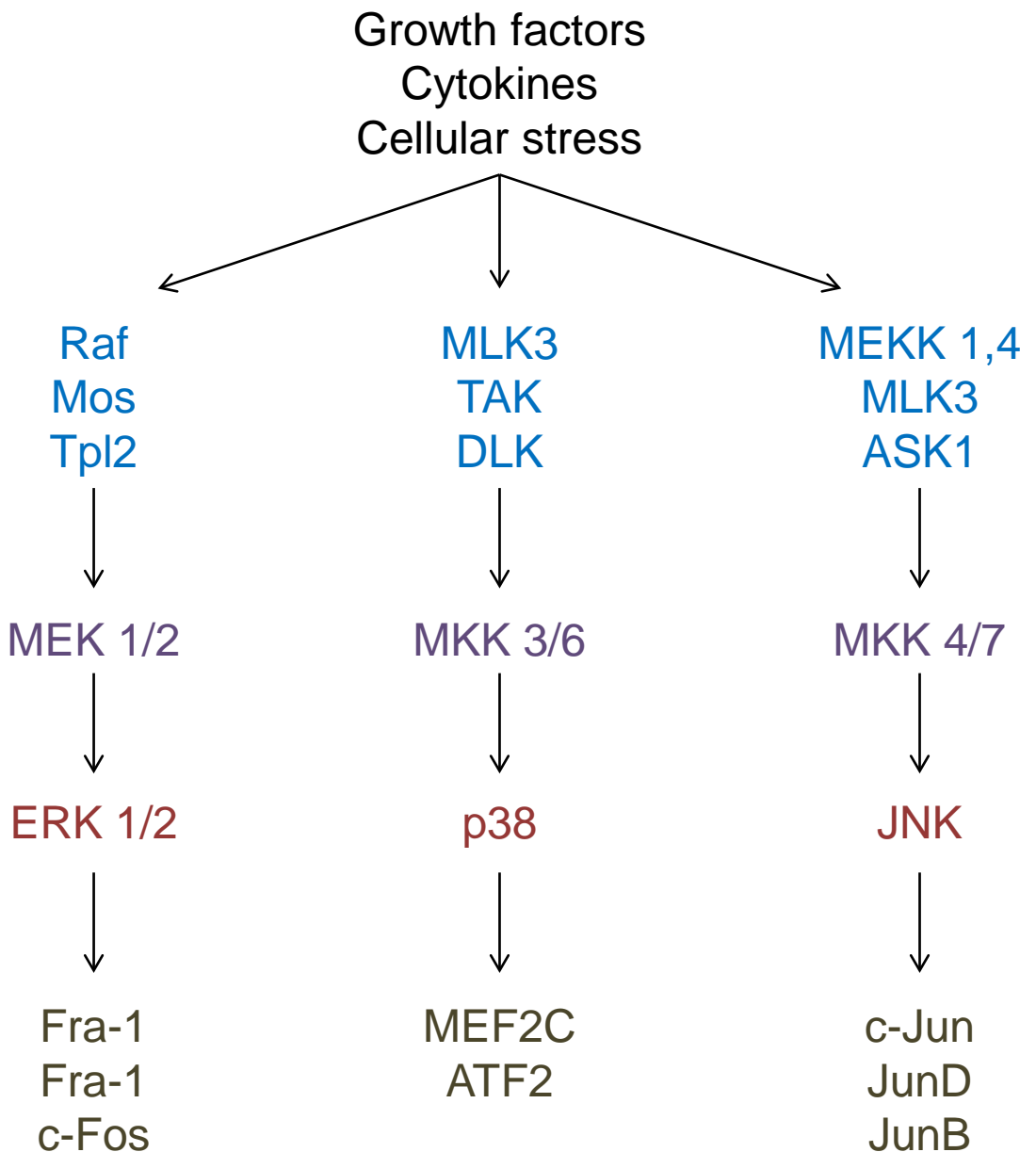

**Figure 20. MAPK signaling cascade targeting AP-1 proteins.** Extracellular growth factors, cytokines, and cellular stress activate the mitogen activated kinases (MAPK) pathways. The MAPK utilize a signaling cascade hierarchy that begins with mitogen activated kinase kinase kinase (MAPKKK). The MAPKKK (Raf, Mos, Tpl2, MLK3, TAK, DLK, MEKK 1.4, ASK1) activate MAPKK (MEK 1/2, MKK 3/6, MKK 4/7), that activate MAPK (ERK 1/2, p38, JNK) which translocates into the nucleus and phosphorylate transcription factors.

kinases such as MEK 1/2, which phosphorylates ERK 1/2. ERK 1/2 becomes activated when phosphorylated in its activation loop, Thr-Glu-Tyr (TEY) (Roux and Blenis, 2004). Once activated, ERK 1/2 can phosphorylate targets such as Elk-1 (Janknecht et al., 1993) and c-Fos (Whitmarsh and Davis, 1996).

The general mechanism of the MAPK signaling cascade for p38 and JNK are similar, but the molecules involved are different. The upstream kinases that activate p38 are MKK3 and MKK6. Activation of p38 occurs via phosphorylation the Thr-Gly-Tyr (TGY) motif (Whitmarsh and Davis, 1996) allowing p38 to phosphorylate targets such as ATF2 and MEF2. MKK4 and MKK7 phosphorylate JNK in its Thr-Pro-Tyr (TPY) motif (Whitmarsh and Davis, 1996). Once activated JNK targets substrates including ATF2 and c-Jun. ERK 1/2, p38 and JNK pathways are important in skeletal muscle differentiation as they target many transcription factors that are involved in muscle specific gene regulation.

### **Cytokine and growth factor signaling in skeletal muscle differentiation**

Key extracellular signaling molecules in skeletal muscle differentiation, such as insulin (D'Alessandris et al., 2007; Illario et al., 2009), insulin-like growth factor-I, (IGF-I), IGF-II (Adi et al., 2002; Czifra et al., 2006) and basic fibroblast growth factor (bFGF) are involved in skeletal myogenesis. Transforming growth factor- $\beta$  (TGF- $\beta$ ) and Cardiotrophin-1 (CT-1) have inhibitory effects on differentiation but may have a function in maintaining satellite cells in adult muscle.

### ***7.1 Insulin, Insulin like growth factors, basic fibroblast growth factor and transforming growth factor-beta***

The peptide hormone, insulin, is primarily produced and secreted from the pancreas and it is known to promote myogenesis (Conejo et al., 2001) as well it is the minimum necessary factor that must be present in cell culture media for differentiation (Haba Gde et al., 1966; Mandel and Pearson, 1974; Smith et al., 1999). Insulin activates the phosphatidylinositol 3 kinase (PI3K) pathway (Tsakiridis et al., 1996) as well as the p38 pathway and is involved in regulating myoblast proliferation and survival (Conejo and Lorenzo, 2001). Insulin-like growth factors IGF-I and II are similar to insulin and are secreted by the liver and skeletal muscle. IGF-I has dual role in skeletal muscle contributing to both proliferation and differentiation. IGF-I is necessary for proliferation in early stages by regulating FoxO1 and p21 via activation of Akt signaling (Machida et al., 2003). Phosphorylation of p21 by Akt inhibits CDK2 while phosphorylation of FoxO1 excludes it from the nucleus preventing transcription of cell cycle inhibitors (Machida et al., 2003). Therefore, both of these mechanisms allow cell proliferation to occur. Activation of Akt by IGF-1 also promotes differentiation. Akt can target pituitary homeobox 2 (Pitx2), which complexes with an mRNA binding protein called HuR to stabilize cyclinD1. However, when Pitx2 is phosphorylated by Akt complex formation is prevented resulting in cyclinD1 degradation (Gherzi et al., 2010). When activated, Akt also targets GSK3- $\beta$  preventing it from phosphorylating  $\beta$ -Catenin thus, promoting expression of muscle specific genes (Pansters et al., 2011). IGF-1 is an important signaling molecule in skeletal muscle development as it has roles in both proliferation and differentiation. IGF-I signaling has been shown to contribute to muscle hypertrophy (Coleman et al., 1995).

Basic fibroblast growth factor (bFGF) activated the MEK 1/2 ERK 1/2 pathway inducing myoblast proliferation (Milasincic et al., 1996). The mechanism is not well defined, but it involved down regulation of MyoD that subsequently hinders differentiation by preventing muscle specific gene expression (Spizz et al., 1986). Expression of the FGF receptor is down regulated during differentiation thus, signaling is turned off (Olwin and Hauschka, 1988).

TGF- $\beta$  is another growth factor that activates downstream phosphorylation events leading to changes in gene expression. Two pathways that are activated by TGF- $\beta$  are the Smad and the ERK 1/2 (Yang et al., 2006) pathways both of which are activated in skeletal muscle. It had been observed that TGF- $\beta$  inhibits skeletal muscle differentiation in C2C12 cells (Olson et al., 1986) by hindering expression of MyoD and myogenin (Brennan et al., 1991) while Smad7, a TGF- $\beta$  receptor inhibitor, promotes differentiation (Kollias et al., 2006). More recently, activation of MEK 1/2 by TGF- $\beta$  was shown to inhibit MyoD activity independent of the Smad pathway (Miyake et al., 2010).

## ***7.2 Interleukin-6 family of cytokines***

Members of the IL-6 family are grouped based on structure similarity and include IL-6, IL-11, leukemia inhibitory factor (LIF), ciliary neurotrophic factor (CNTF), cardiotrophin-like cytokine (CLC), oncostatin M (OSM) and cardiotrophin-1 (CT-1) (Kishimoto et al., 1995). All IL-6 cytokines exclusively utilize the gp130 receptor subunit to transduce signals in the cell. The signaling receptor can be a gp130 homodimer which is used by IL-6 and IL-11 complex with gp130 homodimer while LIF, CTNF and CT-1 use a heterodimer of gp130 and LIFR, OSM uses gp130 and

OSMR (figure 21) (Kishimoto et al., 1995). LIF uses the same receptor as CT-1 and has similar functions as CT-1. IL-6, IL-11, CNTF, and CLC also bind a non-signaling  $\alpha$  receptor but CT-1  $\alpha$ -receptor is predicted but not yet characterized (Robledo et al., 1997). Downstream signaling cascades are activated following receptor activation via tyrosine phosphorylation. Interleukin-6 (IL-6) family of cytokines are involved in a variety of biological processes such as proliferation, differentiation, survival, apoptosis and inflammatory response.

### ***7.3 JAK-STAT signaling***

In cardiac fibroblast, CT-1 is able to activate the JAK/STAT, PI3K/Akt, p38 and ERK1/2 MAPK pathways (Freed et al., 2003a). With the exception of p38, these signaling pathways have been shown to have a role in cardiomyocyte hypertrophy (Tian et al., 2004). Following cytokine binding to gp130-LIFR heterodimer, the signal is transduced by other downstream signaling molecules. Janus kinases (JAKs) are required for gp130 signaling and interact via a FERM (four-point, Ezrin, rodixin, Moesin) domain with proline rich box1 on the receptor (Freed et al., 2003a). There are JAK1, 2, and 2 as well as tyrosine kinases 2 (TYK2) and all are known to associate with gp130-LIFR. Signal transducer and activator of transcription (STAT) are downstream phosphorylation substrates of JAKs (Zhang et al., 1995b). There are seven members of the STAT family STAT 1, 2, 3, 4, 5a, 5b, and 6 and bind via YXXQ motif on gp130-LIFR. STATs contain src homology domain 2 (SH2), which allows it to dimerize with other STATs (Taga and Kishimoto, 1995). Interestingly, gp130/LIFR/OSMR signaling also stimulates the MEK1/2-ERK1/2 pathway. This occurs via SH2 domain containing tyrosine phosphatase (SHP2), which interacts with



growth factor receptor bound protein (grb2) and grb2 associated binder 1 (Gab1). Gab1 interacts with Ras allowing the Ras-Raf-MEK-ERK cascade to become activated (figure 22) (Kishimoto et al., 1995).

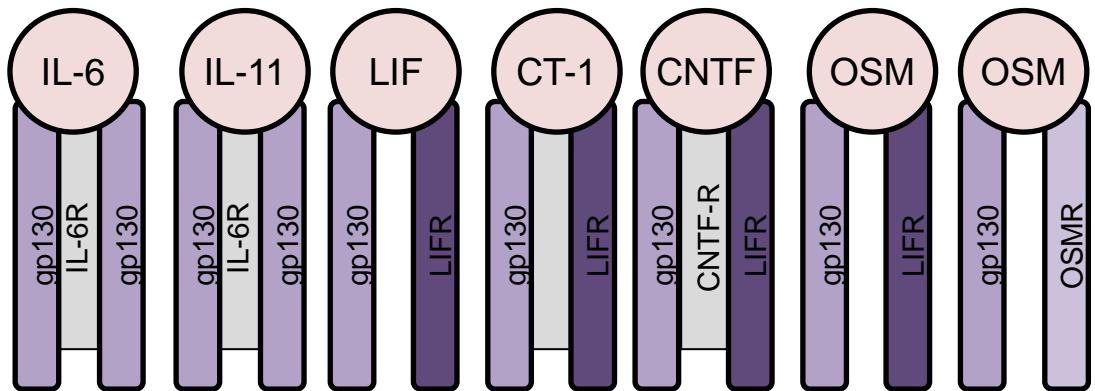

**Figure 21. IL-6 family of cytokines and their receptors.**

The IL-6 family of cytokines share the common receptor subunit gp130. IL-6 and IL-11 use a receptor composed of a gp130 homodimer. LIF, CT-1, CNTF and OSM use receptors that comprises a LIF-R-gp130 heterodimer. OSM can also signal via a heterodimer of OSMR and gp130. IL; Interleukin, LIF; Leukemia inhibitory factor, CT-1; Cardiotrophin-1, CTNF; ciliary neurotrophic factor, OSM; oncostatin M.

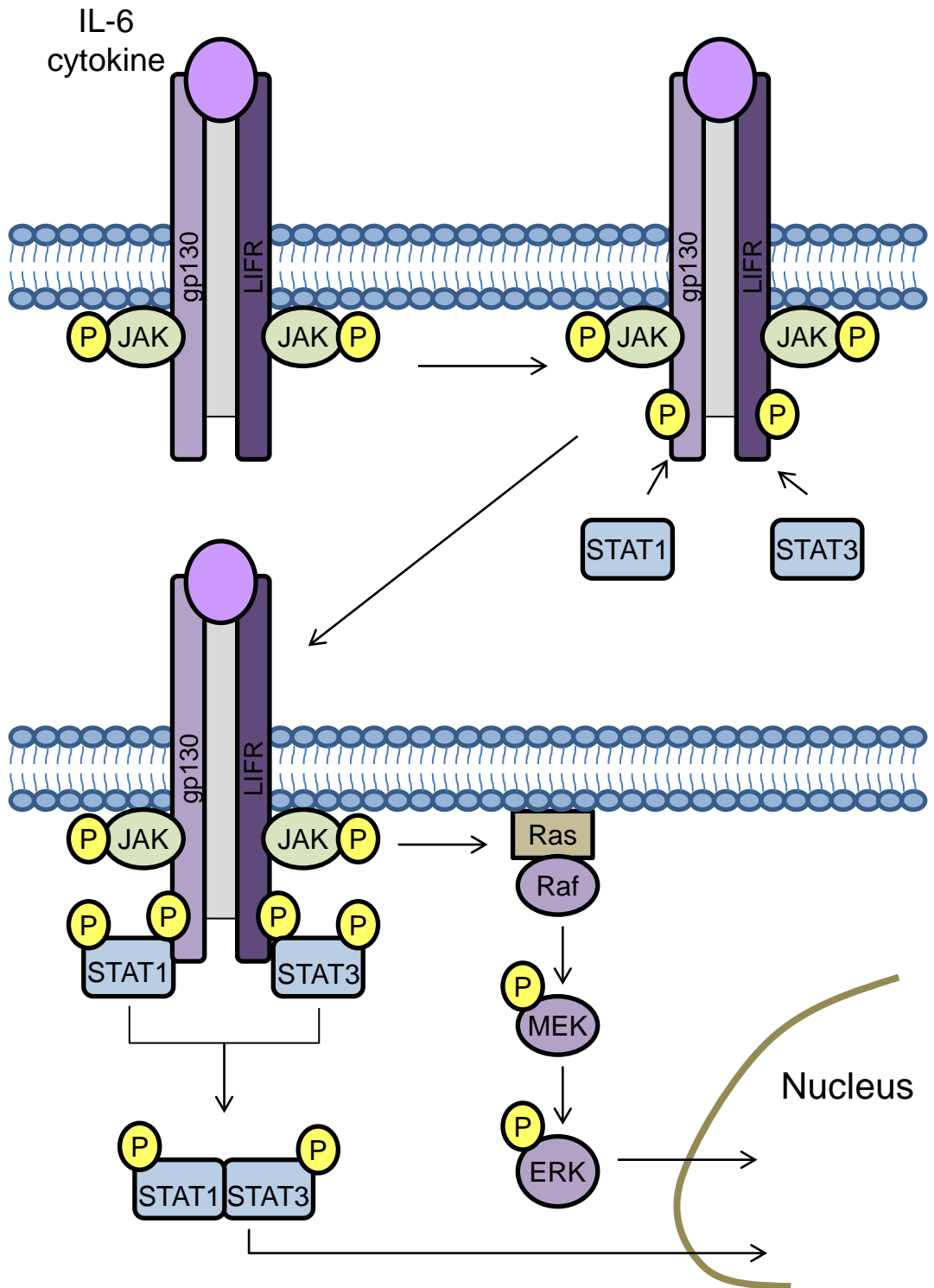

**Figure 22. IL-6 cytokine induced signaling mechanisms.**

Some IL-6 cytokines such as CT-1 and LIF signal via a receptor composed of gp130 and LIFR. Autophosphorylation of the receptor lead to JAK phosphorylation and receptor phosphorylation. STAT3 is recruited to the receptor and phosphorylated. Phosphorylated STAS3 can translocate into the nucleus and activate gene transcription. JAK can mediate activation of the MEK 1/2 , ERK 1/2 pathway.

#### ***7.4 Cardiotrophin-1***

Cardiotrophin-1 (CT-1) is a cytokine identified in a screen for cardiac hypertrophic factors that were induced from embryoid bodies from mouse embryonic stem cells in conditioned media (Pennica et al., 1995). CT-1 is expressed in the heart tube E8.5-E10.5 in myocardial cells and after E12.5 it is found in other tissues such as liver, dorsal root ganglia and skeletal muscle. In addition to being a factor that induces cardiac hypertrophy (Pennica et al., 1995), CT-1 is also involved in cardiomyocyte survival (Sheng et al., 1996). CT-1 activates atrial natriuretic peptide (ANP) in cardiac cells. Clinically, CT-1 has been implicated in cardiac related diseases (Celik et al., 2012; Freed et al., 2005) and more recently, has been associated with hypertension (Gkaliagkousi et al., 2014) and diabetes (Hung et al., 2013). In addition to cardiac cells, various roles for CT-1 in other cell types have been proposed. For example in hepatocytes, CT-1 is involved in the inflammatory process (Peters et al., 1995; Richards et al., 1996), and in motorneurons it promotes cell survival (Holtmann et al., 2005; Oppenheim et al., 2001). In skeletal muscle, CT-1 signaling has been shown to repress MyoD activity by activating MEK1/2 resulting in reduced myotube differentiation (Miyake et al., 2009).

#### ***7.5 CT-1 and myogenesis***

CT-1 is not expressed in the somites or myogenic progenitor cells, but later in skeletal muscle tissue. It is expressed after E 12.5 in skeletal muscle suggesting it may have a role in skeletal muscle maintenance. CT-1 was shown to have a role in regenerating and overloaded skeletal muscle and its expression was detected in satellite cells (Nishikawa et al., 2005). Both gp130 and LIFR are expressed in regenerating

skeletal muscle (Kami et al., 2000). LIF, similar to CT-1 impedes differentiation of C2C12 myoblasts into myotubes (Jo et al., 2005). IL-6 induces skeletal muscle hypertrophy and satellite cell proliferation using signaling that activates STAT3 (Serrano et al., 2008). It was demonstrated that JAK2 and STAT2 and 3 were required for myogenic proliferation and differentiation, actually preventing premature differentiation (Sun et al., 2007; Wang et al., 2008). In addition, it was shown that JAK1 down regulation accelerated myogenesis causing an increase in MyoD and MEF2 and decreasing Id1 (Sun et al., 2007). In a separate study STAT3 was shown to increase c-myc and antagonize MyoD via a direct interaction (Kataoka et al., 2003). However, it was later demonstrated that MEK1/2 signaling, at least when activated by CT-1, was involved in inhibitory effects of myogenesis not STAT3 signaling (Miyake et al., 2009).

## **Chapter II: Statement of Purpose**

## **Chapter II: Statement of Purpose**

Skeletal muscle development and regeneration is applicable to numerous pathologies, in which muscle wasting is a consequence. A greater understanding of the molecular processes involved in skeletal muscle development and regeneration may further clinical applications such as sarcopenia and cancer cachexia. Regulation of skeletal muscle development by the MRFs and MEF2 transcription factors are well characterized and documented. Other more ubiquitous transcription factors are also implicated in regulation of skeletal muscle such as the AP-1 family of proteins. However, the understanding of AP-1 transcription factors' role is incompletely characterized in skeletal muscle. Hence, the overall purpose here was to further characterize the role of AP-1 in skeletal muscle. This general purpose was addressed in the following specific studies.

## **Chapter III: CT-1 maintains the undifferentiated state in skeletal myoblasts**

During embryogenesis CT-1 is primarily expressed in cardiomyocytes but is also expressed in skeletal muscle. The role of CT-1 as a cardiac hypertrophic factor is established, but its' role in skeletal muscle still remains unknown. Two signaling pathways activated by CT-1 in cardiomyocytes; MEK 1/2/ERK 1/2 and JAK/STAT, have an inhibitory effect on skeletal muscle. In this study the role of CT-1 in skeletal muscle was assessed, and the signaling mechanisms constituting its effects were investigated.

#### **Chapter IV: Signal dependent Fra-2 regulation in skeletal muscle reserve and satellite cells**

Previously, it was demonstrated that components of the AP-1 transcription factor complex were present in proliferating and differentiating skeletal muscle. Some components of the AP-1 transcription factor complex, such as Fra-2, were determined to be posttranslationally modified. ERK 1/2, a known upstream kinase of Fra-2, has an inhibitory signaling effect upon skeletal muscle differentiation. In this study, the regulation of Fra-2 by ERK1/2 signaling and its' role in skeletal muscle development was investigated.

Overall, these studies were aimed at further elucidating the function of AP-1 in skeletal muscle.



## **Chapter III: Cardiotrophin-1 maintains the undifferentiated state in skeletal myoblasts**

Published in “The Journal Biological Chemistry”  
(2009), vol 284, 19679-19693

Experimental design and drafting manuscript  
Tetsuaki Miyake and Dr. John C McDermott

Conducting experiments  
Tetsuaki Miyake; (figure 1B, 3, 4A, 4B, 4D, 4E, 5A, 5B, 5C, 5D, 5E, 6A,  
6B, 6C, 6D, and Supplemental figure 1 and 2)

Nezeka S Alli and Arif Aziz; (figure 1A, 1C, 1D, 2, and 4C)

Jennifer Knudson, Pasan Fernando, and Dr.Lynn A. Megeney; (figure 7A,  
7B, 7C, 7D, and 7E)

June 12, 2014

Ms. Nezeke Alli  
Department of Biology, York University  
4700 Keele Street, Toronto,  
Ontario, M3J 1P3

Dear Ms. Alli,

I gave permission to Ms. Alli, Nezeke to use the part of my dissertation, **“Cardiotrophin-1 maintains the undifferentiated state in skeletal myoblasts”** in Ms. Alli’s dissertation for her PhD degree, as she greatly contributed to this part of the project.

Sincerely,

A handwritten signature in black ink that reads "T. Miyake". The signature is written in a cursive style with a large, stylized initial "T" and a long, sweeping underline.

Tetsuaki Miyake PhD  
Post-Doctoral Fellow, Department of Physiology, University of Toronto

# **Cardiotrophin-1 maintains the undifferentiated state in skeletal myoblasts**

**Tetsuaki Miyake\***, **Nezeka S. Alli\***, **Arif Aziz\***, **Jennifer Knudson<sup>α</sup>**, **Pasan Fernando<sup>α</sup>**,  
**Lynn A. Megey<sup>α</sup>**, and **John C. McDermott\***

\*Department of Biology, York University, 4700 Keele street, Toronto, Ontario, M3J 1P3 Canada. <sup>α</sup>The Sproul Center for Stem Cell Research, Regenerative Medicine Program, Ottawa Health Research Institute, 501 Smyth Road, Ottawa, Ontario, K1H 8L6, Canada.

correspondence to: John C. McDermott, Department of Biology, 327 Farquharson, LSB, York University, 4700 Keele St., Toronto, Ontario, Canada. M3J 1P3  
Fax:(416)-736-5698, E-mail: [jmcderm@yorku.ca](mailto:jmcderm@yorku.ca)

Running title: CT-1 inhibits skeletal myogenesis

## Summary

Skeletal myogenesis is potently regulated by the extracellular milieu of growth factors and cytokines. We observed that Cardiotrophin-1 (CT-1), a member of the Interleukin-6 (IL-6) family of cytokines, is a potent regulator of skeletal muscle differentiation. The normal up-regulation of myogenic marker genes, Myosin Heavy Chain (MyHC), Myogenic Regulatory Factors (MRFs), and Myocyte Enhancer Factor 2s (MEF2s) were inhibited by CT-1 treatment. CT-1 also represses Myogenin (MyoG) promoter activation. CT-1 activated two signaling pathways: Signal Transducer and Activator of Transcription-3 (STAT3), and Mitogen-Activated Protein Kinase Kinase (MEK), a component of the Extracellular Regulated MAP Kinase (ERK) pathway. In view of the known connection between CT-1 and STAT3 activation, we surprisingly found that pharmacological blockade of STAT3 activity had no effect on the inhibition of myogenesis by CT-1 suggesting that STAT3 signaling is dispensable for myogenic repression. Conversely, MEK inhibition potently reversed the inhibition of myotube formation and attenuated the repression of MRF transcriptional activity mediated by CT-1. Taken together, these data indicate that CT-1 represses skeletal myogenesis through interference with MRF activity by activation of MEK/ERK signaling. In agreement with these *in vitro* observations, exogenous systemic expression of CT-1 mediated by adenoviral vector delivery increased the number of myonuclei in normal post-natal mouse skeletal muscle and also delayed skeletal muscle regeneration induced by cardiotoxin (CTX) injection. The expression pattern of CT-1 in embryonic and post-natal skeletal muscle and *in vivo* effects of CT-1 on myogenesis implicate CT-1 in the maintenance of the undifferentiated state in muscle progenitor cells.

## Introduction

Terminal differentiation of skeletal myogenic cells, termed myogenesis, consists of a series of well characterized highly regulated steps that has become a paradigm for lineage acquisition and cellular differentiation. Initially, pluripotent mesodermal stem cells commit to become myogenic precursor cells. Commitment to the myogenic lineage then results in the binary state of either maintenance of proliferative potential and pluripotency, or, on appropriate cues, withdrawal from the cell-cycle, activation of a battery of structural, contractile and metabolic genes constituting the differentiation programme and ultimately formation of multi-nucleated myotubes (Perry and Rudnick, 2000). The field of myogenesis has benefited from the use of well established *in vitro* cell-culture systems which faithfully recapitulate the *in vivo* differentiation programme. During myogenesis, a group of basic helix-loop-helix transcription factors, Myogenic Differentiation-1 (MyoD), Myogenic Factor-5 (Myf5), Myogenin (MyoG), and Myogenic Regulatory Factor-4 (MRF4), collectively termed the Myogenic Regulatory Factors (MRFs), play essential roles in differentiation (Kassar-Duchossoy et al., 2004; Pownall et al., 2002; Rudnicki and Jaenisch, 1995). Most promoter-enhancer regions of muscle specific genes contain the cognate binding site, E-box (CANNTG), for the MRFs, and the E-box is often essential for the induction of these genes during differentiation (Tapscott, 2005; Walsh and Gualberto, 1992). For example, early and late muscle specific genes, MyoG and muscle specific Myosin Heavy Chain (MyHC) respectively, are transcriptionally regulated by MyoD and other MRFs through E-boxes in their proximal promoter regions (Penn et al., 2004; Rudnicki and Jaenisch, 1995). The molecular and genetic requirement for the MRFs during myogenesis has been

confirmed in many studies both *in vitro* and *in vivo* (Edmondson and Olson, 1989; Kassar-Duchossoy et al., 2004; Myer et al., 2001). The MRFs also co-operate with another class of myogenic transcription factors, comprised of the Myocyte Enhancer Factor two family (MEF2) (Naya and Olson, 1999; Olson et al., 1995). MEF2 genes are taxonomically part of the MADS-box gene super-family that encode DNA binding proteins involved in yeast mating type decisions (MCM1), plant development (Agamous and Deficiens), and serum responsivity of mammalian cells (Serum Response Factor: SRF) (Jarvis et al., 1989; Norman et al., 1988; Sommer et al., 1990; Yanofsky et al., 1990).

As well as the detailed knowledge of core transcriptional regulatory circuits mediated by myogenic transcription factors and their accessory factors, much work has contributed to the identification of a number of growth factor and cytokine mediated signaling pathways that positively and negatively impact myogenesis (Engert et al., 1996; Olwin and Hauschka, 1988; Ridgeway et al., 2000; Templeton and Hauschka, 1992). In some cases, these pathways regulate the decision to differentiate or not, a critical regulatory point since differentiation in muscle is terminal and absolutely required for viability of all metazoan life. Moreover, negative regulation of differentiation is equally important since it underpins the maintenance of the proliferative state and pluripotency.

A number of growth factors and cytokines, such as Insulin like Growth Factors (IGFs), insulin, Transforming Growth Factor- $\beta$  (TGF $\beta$ ), Fibroblast Growth Factor (FGF), and Epidermal Growth Factor (EGF), that influence myogenesis have been identified (Allen and Boxhorn, 1987; Engert et al., 1996; Olwin and Hauschka, 1988;

Templeton and Hauschka, 1992), however, a detailed understanding of their corresponding signal transduction pathways and transcriptional network targets is still rudimentary. One group of cellular signaling cascades that are known to affect myogenesis in a complex manner are the MAPK pathways. For example, p38 MAPK, a member of one of the MAPK pathways, directly phosphorylates and activates E47, which forms a productive dimer with MyoD (Lluis et al., 2005; Lluis et al., 2006). P38MAPK also regulates MEF2 (Cox et al., 2003; Zetser et al., 1999) transcription factors as well as being involved in the recruitment of ATP dependent chromatin remodelling factors to myogenic loci (de la Serna et al., 2005; McKinsey et al., 2002; Serra et al., 2007). Conversely the ERK-MAPK cascade plays a bi-phasic role in myogenic cells, being inhibitory in the initial phases of the differentiation program while being required for later stage events, such as cell fusion (Bennett and Tonks, 1997).

CT-1 is a member of the IL-6 family, which is comprised of IL-11, Leukemia inhibitory factor (LIF), Ciliary Neurotrophic Factor (CNTF), and Oncostatin M (OSM). These cytokines are structurally related and form a variety of oligomeric ligand – receptor complexes. IL-6 and IL-11 form a complex with a homodimer of the Glycoprotein-130 (Gp130) receptor or heterodimers of gp130 and leukaemia inhibitory factor receptor- $\beta$  (LIFR $\beta$ ). Gp130/LIFR $\beta$  also recognises LIF, CT-1, CNTF, OSM, and Cardiotrophin-Like Cytokine (CLC). OSM binds to the Gp130 and Oncostatin M receptor (OMR). Upon formation of the requisite complex with the respective cytokine, the preponderant view is that the oligomeric receptor complex transduces its signal through the Janus kinase (JAK)-STAT signaling pathway (Heinrich et al., 2003).

CT-1 was originally identified in conditioned medium from embryoid bodies (Pennica et al., 1995). In developing embryos, CT-1 is expressed in heart, skeletal muscle, liver and dorsal root ganglia (Sheng et al., 1996). In adults, human CT-1 mRNA is detected in the heart, skeletal muscle, ovary, colon, prostate and testis, and in fetal kidney and lung (Pennica et al., 1996). The functions of CT-1 in the cardiovascular system have been extensively researched. Patients with ischemic and valvular heart disease have elevated levels of CT-1 in their sera (Freed et al., 2003b). Further study of the role of CT-1 in the heart indicated that it has a cardio-protective role by reducing apoptosis (Brar et al., 2001; Sheng et al., 1996) and may be involved in regeneration of cardiac muscle after infarction (Freed et al., 2005). Exogenously administered CT-1 also induces cardiac hypertrophy *in vitro* (Sheng et al., 1996). While the modulation of cardiomyocyte phenotype by CT-1 has been well documented, the underlying signaling pathways are still unclear and the role of CT-1 in skeletal muscle has not, thus far, been characterized.

In this report, we demonstrate that CT-1 is a potent inhibitor of skeletal muscle differentiation. In C2C12 cells, CT-1 represses molecular markers of muscle differentiation and phenotypic myogenesis. Also, the transcriptional networks involved in the induction of key myogenic genes such as the MyoG and MCK genes are suppressed by CT-1 signaling. Surprisingly, small chemical inhibitors of MEK, PD98059 and U0126, reversed these repressive effects on skeletal myogenesis by CT-1 whereas inhibition of STAT3 activation was without effect. Collectively, these data show that CT-1 interferes with the transcriptional network required for muscle differentiation through the activation of the MEK-MAPK signaling module.



Furthermore, *in vivo*, adenovirus mediated expression of CT-1 increases satellite cell number and delays regeneration of damaged muscle by cardiotoxin (CTX) injection. These observations indicate that CT-1 represses myogenesis and serves to maintain myogenic progenitors in their proliferative, multipotent state *in vitro* and *in vivo*.

## Experimental procedures

**Plasmids** MRF expression plasmids were constructed in pEMSV as described elsewhere (Davis et al., 1987). An activated ( $\Delta$ N3 S218D/S222E) human MEK1 expression construct was a kind gift from A. Natalie (Mansour et al., 1994). The reporter construct pMCK-eGFP was a gift from A. Ferrer-Martinez (Universitat de Barcelona, Spain). Transcription reporter constructs, pMCK-luc (Donoviel et al., 1996), pCMV- $\beta$ -Galactosidase were described elsewhere (Kollias et al., 2006). The myogenin promoter region was excised from pMyoG-luc by *SacI*/*Bgl II* digestion. The resultant 1152bp fragment was inserted at the *SacI*/*Bgl II* sites of pGL4-10 vector (Promega). The dsRed2-N1 expression construct was purchased from Clontech Laboratories.

**Antibodies** The primary antibodies used in this study were obtained from Santa Cruz Biotechnology; MyoD (C-20), Myf5 (C-20), Actin (I-19), and ERK1 (C-16), from BD Biosciences; MEF2D (610775), from Cell Signaling Technology; Stat3 (9132), Phospho-Stat3 (Tyr705) (58E12; 9135), Phospho-Stat3 (Ser727) (6E4; 9136), MEK1/2 (9122), Phospho-MEK1/2 (Ser217/221) (9121), Phospho-p44/42 MAPK (Thr202/Tyr204) (E10; 9106), from Developmental Studies Hybridoma Bank; Myogenin (F5D), and MyHC (MF20), from DakoCytomation; MyoD1 (clone:5.8A; M3512). Polyclonal antibody for MEF2A was prepared as previously described (Cox et al., 2003). Normal mouse (sc-2025) IgG was from Santa Cruz Biotechnology.

**Cell Culture** C2C12 myoblasts were obtained from American Type Culture Collection (CLR-1772) and cultured in growth medium (GM) consisting of 10% Fetal bovine serum (FBS) (HyClone) in high-glucose Dulbecco's modified Eagle's medium (DMEM) (Gibco) supplemented with 1% penicillin-streptomycin (Gibco) at 37 °C and 5% CO<sub>2</sub>. Myotube formation was induced by replacing GM with differentiation medium (DM) which consisted of 2% horse serum (Atlanta Biologicals) in DMEM supplemented with 1% penicillin-streptomycin. For CT-1 treatment, recombinant mouse CT-1 (R&D system; 438-CT) was resuspended with solvent (4 mM HCl, 0.1% bovine serum albumin (BSA)) and supplemented into the media. For myotube formation assays, DM with CT-1 (10ng/ml) was replenished every 2 days. Inhibitors (PD98059 (Cell Signaling Technology; 9900), U0126 (Cell Signaling Technology; 9903), and P6 (2-(1,1-Dimethylethyl)-9-fluoro-3,6-dihydro-7H-benz[h]-imidaz[4,5-f]isoquinolin-7-one; Pyridone 6) (Calbiochem; 420097)) were resuspended with DMSO and added into the cell culture media for 30 minutes prior to adding CT-1.

### **Sacromeric Myosin Heavy Chain Detection**

C2C12 cells were washed with Phosphate buffered saline (PBS) (pH7.4) and fixed with 90% methanol at -20 °C for 10 min. After fixation, the cells were incubated in 5% milk in PBS for 30 min at 37 °C for blocking. Cells were incubated at room temperature with MF-20 (primary antibody) diluted in blocking buffer (5% milk PBS) for 1 hour. After incubation, the cells were washed three times with PBS and incubated for 60 min at room temperature with an Horseradish peroxidase (HRP)-conjugated  $\alpha$ -mouse secondary antibody. The cells were again washed three times with PBS and incubated

in developer (0.6 mg/ml DAB, 0.1 % H<sub>2</sub>O<sub>2</sub> in PBS) to detect MyHC by immunocytochemistry. The nuclei were counter-stained with haematoxylin. Images were recorded with a microscope (Axiovert 35; Carl Zeiss MicroImaging) with either 4X NA 0.10 or 10X NA 0.25 Achromat objective lenses with a digital camera (Canon, EOS D60).

**Proliferation assay** After 72hrs in DM and in the presence of CT-1 (10ng/ml) (or solvent), cells were incubated with 100µM of BrdU (Sigma) for 1 hr at 37°C. Cells were washed with cold 1x PBS then fixed with 70% ethanol for 1hr at 4°C. The cells were then washed with 1x PBS and incubated with 2N HCl for 1 h at 37°C to denature the DNA. The cells were blocked in 10% goat serum (Sigma) diluted in 1x PBS for 2hrs at room temperature with shaking and then incubated with BrdU primary antibody (G3G4: Developmental hybridoma bank, Iowa) diluted in 1.5% goat serum (Sigma) for 1.5hr at room temperature with shaking. Cells were washed with 1x PBS-T (0.5% Tween20) and incubated with anti-mouse secondary antibody conjugated to FITC (Sigma) diluted in 1.5% goat serum (Sigma) for 2hrs at room temperature with shaking. Cells were washed with 1x PBS-T (0.5% Tween20).

**Microscopy and Fluorescence** Fluorescence and phase contrast pictures were obtained using an epifluorescence microscope (Axiovert 35; Carl Zeiss MicroImaging), with appropriate phase and filter settings, and either 4X NA 0.10 or 10X NA 0.25 Achromat objective lenses. Images were recorded with a digital camera (Canon, EOS D60).

**Western blotting analysis** Total cellular protein extracts were prepared in NP-40 lysis buffer (0.1 % NP-40, 150 mM NaCl, 1mM EDTA, 50 mM Tris-HCl pH 8.0, 1mM sodium vanadate, 1mM PMSF, supplemented with a protease inhibitor cocktail (Sigma, P-8340)). Protein concentrations were determined by a standard Bradford assay (BioRad). Equivalent amounts of protein were resolved by SDS-PAGE gels, followed by electrophoretic transfer to an Immobilon-P membrane (Millipore) as directed by the manufacturer (Millipore). Blots were incubated with the indicated primary antibody in 5% milk in PBS or Tris buffered saline (TBS)-T (10mM Tris-HCl pH8.0, 150mM NaCl, 0.1% Tween-20) or 5% Bovine serum albumin (BSA) in TBS-T according to the manufacturer's protocol at 4 °C overnight with gentle agitation. After washing briefly, the blots were incubated with the appropriate HRP-conjugated secondary antibodies in 5% milk in PBS or TBS-T at room temperature according to the manufacturer's protocols (Santa Cruz Biotechnology, Cell Signaling Technology). After washed three times with 1XPBS or 1XTBS (depending on the primary antibody) at room temperature, the blots were treated with the Enhanced chemiluminescence reagent (Amersham) to detect immuno-reactive proteins. The blots were exposed to Biomax film (Kodak) for visual representation.

**Transcription reporter gene assays** C2C12 myoblasts were transfected by a standard calcium phosphate-DNA precipitation method with the indicated reporter gene and expression constructs and pCMV- $\beta$ -Galactosidase to monitor transfection efficiency. After transfection, the cells were washed with PBS and maintained in GM and then treated as indicated. Total cellular protein was extracted with luciferase lysis

buffer (20mM Tris-HCl pH7.4, 0.1% Triton X-100). Luciferase and  $\beta$ -Galactosidase enzyme assays were performed according to the manufacturer's protocol (Promega). Luciferase activity was quantified using a luminometer (Berthold Lumat, 9501) and standardized according to the  $\beta$ -Galactosidase activity. Relative Luciferase units normalized for the  $\beta$ -Galactosidase activity (Relative Luciferase Unit; RLU) were determined and plotted as an average of triplicate determinations and error bars represent standard deviations of the triplicate values. Each experiment was repeated at least three times.

**Semi-quantitative RT-PCR analysis** Total RNA was extracted from cells with TRIzol (Invitrogen) according to manufacturer's protocol. cDNA was generated from the isolated total RNA (1 $\mu$ g) with SuperScript III (Invitrogen) and oligo-dT<sub>(16)</sub> primer (Sigma) by the protocol provided by the manufacturer. To amplify a target transcript, a pair of primers was designed that flanked an intron based on the mouse gene sequences. The target transcripts were amplified by *taq* DNA polymerase (New England Biolab) with gene specific primers. An amplified DNA was separated in an agarose gel and visualized by ethidium bromide (EtBr) (Sigma) staining and UV exposure. Detailed information about the primers is in supplement.

**Co-immunoprecipitation analysis** An equal amount of total cellular protein (250 $\mu$ g) was diluted with NP-40 lysis buffer to a final concentration of 1  $\mu$ g/ $\mu$ l. Protein complexes were immunoprecipitated with the indicated antibody and 25 $\mu$ l of protein G-Plus Sepharose beads (50% slurry) (Santa Cruz Biotechnology) by incubation at 4°C

overnight on a rotating platform. The beads were washed with three changes of NETN wash buffer (0.1% NP-40, 150mM NaCl, 1mM EDTA, and 50 mM Tris-HCl pH 8.0). Beads were boiled in SDS sample buffer, and protein complexes were resolved by SDS-PAGE and immuno-blotted as described above.

**CT-1 adenovirus** The CT-1 adenovirus was previously described (Bordet et al., 1999). Briefly, full length murine CT-1 cDNA was isolated by PCR and the CT-1 reading frame was fused with a 60 base pair pre-Nerve Growth Factor (NGF) leader sequence to promote secretion of the CT-1 protein. The CT-1 cDNA was cloned in frame with the long terminal repeat of the Rous Sarcoma virus (RSV) (Bordet et al., 1999). A LacZ containing adenovirus (CTRL) was used as a control for all injection experiments. This adenovirus was kindly provided by Dr. Robin Park at the Ottawa Health Research Institute, Ottawa, Canada.

***In vivo* administration of CT-1: Muscle injury** To test CT-1 *in vivo*, B6C3F1 mice were subjected to systemic delivery of the CT-1 adenovirus. Briefly, animals were anaesthetized with halothane. The injections were administered via intra-cardiac chamber delivery using a 29-gauge insulin needle (VWR) with 50 $\mu$ L of Ad-CT-1 at a concentration of  $3.0 \times 10^8$  PFU/mL (n=3). A control group of B6C3F1 mice were injected with 50 $\mu$ L Ad-CTRL at a similar concentration (n=3). In a separate group of animals, cardiotoxin was used to induce muscle injury immediately prior to AdCT-1 and Ad-CTRL injection (n=3 for each group). 25 $\mu$ l of 10 $\mu$ M cardiotoxin (Latoxan) was injected directly into the TA muscle using a 29G1/2 insulin syringe in halothane

anaesthetized mice (Asakura et al., 2002). Post-recovery, mice were monitored closely for weight loss, dehydration and cardiac distress. All injections were administered by a trained animal care technician according to the standards of the Animal Care Committee at the University of Ottawa, Ottawa, Canada.

**Immuno-histology** At 7days post-injection, skeletal muscle was excised and rinsed in cold 1XPBS. The muscle was fixed in 4% PFA in PBS for 2days then embedded in paraffin, sectioned at 10 $\mu$ M and counterstained with haematoxylin and eosin to visualize the nuclei and cytoplasm. Sections were dehydrated in a graded ethanol series ending in CitriSolv (Fisher Scientific). For immuno-histological, sections were treated with antigen unmasking solution (Vector Labs), blocked with 5% BSA, incubated overnight at 4°C with a primary antibody, then incubated in donkey-anti-goat CY3 antibody (Chemicon) and finally counterstained with DAPI (Sigma). 5 fields of view per section and 5 sections per TA muscle were analysed. The micrographs were representative views.

**Stem Cell/Progenitor Cell Isolation** Side population (muscle progenitor cells) were collected as previously described (Hierlihy et al., 2002). Contra lateral TA muscle was collected from Ad-CT-1 and Ad-CTRL mice and all visible connective tissue and blood vessels were removed by dissection. Muscle was digested in collagenase B (10mg/mL) (Roche) plus dispase II (2units/mL) (Roche) for and the resulting single cell suspensions were then stained with Hoechst dye 33342 (5 $\mu$ g/mL) (Sigma-Aldrich) at 37°C for 90 minutes. As an SP control, the drug verapamil (50 $\mu$ M) (Sigma-Aldrich) was added to



an aliquot of cells simultaneously stained with Hoechst 33342. Cells were finally re-suspended in 500 $\mu$ L of Hanks Balanced Salt solution with 2% FBS and 10mM Hepes (HBSS+). The cells were filtered through a 50 $\mu$ M Cell Tric<sup>®</sup> (disposable filters made of monofil nylon material) (Partec GmbH) and remained on ice until FACS analysis (Hierlihy et al., 2002). Cell sorting was performed using a DakoCytomation MoFlo high-speed cell sorter (DakoCytomation) (Hierlihy et al., 2002). Forward and side scatter was measured at 488 nm (Spectraphysic Argon Laser). The Hoechst dye was excited at 359nm (I90C laser from Coherent). Blue emission was measured at 424nm (424/44 band pass filter) and red emission was above 675nm (675 AGLP long pass filter). All data was collected and analyzed with Summit<sup>™</sup> Data Acquisition and Analysis Software (DakoCytomation).

**Methylcellulose Stem Cell/Progenitor Cell Culture**  $2 \times 10^4$  Side population cells were re-suspended in 2.5mL of Methocult media GF3434 (Stem Cell Technologies) using a 5mL syringe and a 12 gauge needle (Hierlihy et al., 2002). Cells were then plated on 2cm plastic petri dishes and incubated in humidity chambers at 37°C and 5% CO<sub>2</sub> for 14days. At 14days post plating, colonies were counted using a Zeiss inverted microscope.

**Statistical Analysis** Differences between Ad-CT-1 and Ad-CTRL injected samples were evaluated for statistical significance using one tailed, unpaired Student's *t* test. Differences were considered statistically significant at a p value less than 0.05

## Results

### *CT-1 represses myogenic differentiation*

Major sites of CT-1 expression during embryonic development are heart and skeletal muscle (Sheng et al., 1996). While CT-1's role in the cardiovascular system is being defined (Sheng et al., 1997), its role in skeletal muscle is not characterized. To begin to elucidate CT-1 function in skeletal muscle, we initially treated C2C12 cells chronically with CT-1 (10ng/ml, 0.5nM) and assessed muscle differentiation by the formation of multi-nucleated myotubes and accumulation of a skeletal muscle differentiation marker protein, MyHC. Solvent treated C2C12 cells began to exhibit multinucleated myotubes after 48hrs in DM. Thereafter, the control, solvent treated C2C12 cells developed MyHC-positive myotubes with large numbers of nuclei at later time points (figure 1A). In contrast, C2C12 cells in the CT-1 containing DM failed to form multinucleated myotubes at 48hrs. At later time points, some myogenesis occurred although the number and calibre of MyHC-positive myotubes were greatly reduced in the presence of CT-1 compared to the corresponding controls (figure 1A). In addition, the MCK promoter activity was strongly inhibited by CT-1 as indicated by the transfection of a MCK promoter-reporter gene fused to enhanced signal Green Fluorescent Protein (EGFP) (pMCK-EGFP) (figure 1B). We also observed that CT-1 did not affect the cellular proliferation rate of differentiating myoblasts in DM assessed by BrdU incorporation rate (figure 1C&D). Therefore, these data document that CT-1 represses the skeletal muscle differentiation programme without affecting proliferation rate.

A)

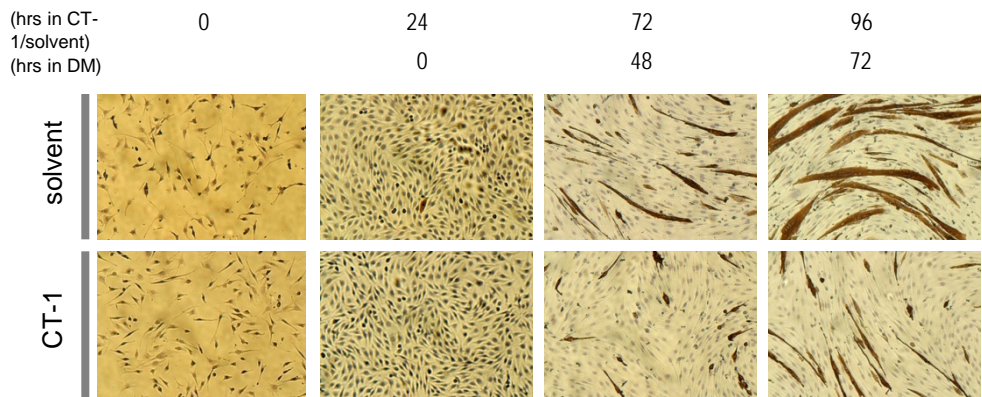

B)

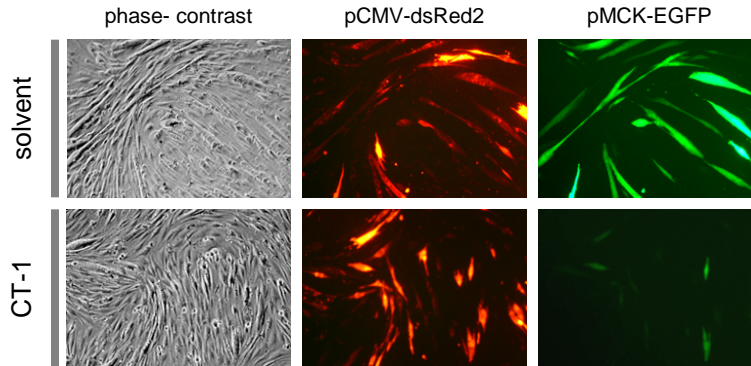

C)

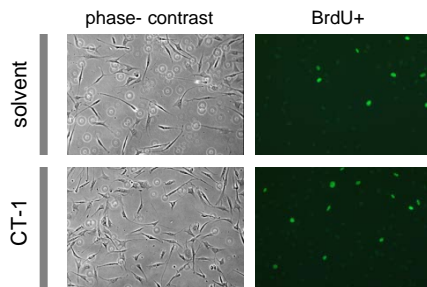

D)

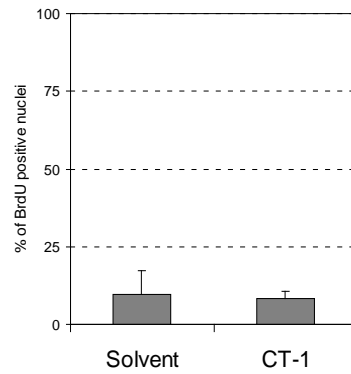

Figure 1

**Figure 1. CT-1 represses myogenic differentiation.** A) C2C12 cells were seeded onto cell culture plates at equal density and maintained in CT-1 (10ng/ml) or solvent containing growth medium (GM) or differentiation medium (DM) for the indicated time period. The cells were fixed and stained for muscle myosin heavy chain (MyHC) detection by immunocytochemistry. The photomicrographs are representative fields in each condition. B) C2C12 cells were plated at equal density and transfected with pCMV-deRed2 and pMCK-eGFP constructs. The transfected cells were maintained in CT-1 (10ng/ml) or solvent containing DM for 72 hrs to induce myotube formation. The cell morphology was recorded by phase-contrast microscopy and transfected cells were monitored by the red fluorescence signal. MCK promoter activity was assessed by the green fluorescence signal. C) C2C12 cells were maintained in DM for 72hrs and CT-1 (10ng/ml) or solvent was added every 24hrs. After 72hrs in low serum conditions cells were incubated with 100 $\mu$ M of BrdU for 1hr. Cells were then fixed with 70% ethanol and then incubated with 2N HCl to denature the DNA. The cells were then blocked with 10% goat serum prior to incubation with BrdU primary antibody. The cells were then washed with 1x PBS-T and incubated with secondary antibody conjugated to FITC. The cells were washed with 1x PBS-T and mounted using fluorescence mounting media and viewed under a fluorescence microscope. D) The average of percentage of BrdU positive nuclei over total nuclei in 12 individual fields per condition was calculated and graphed. (error = standard variation)

***CT-1 represses the expression of pro-differentiation transcriptional regulators  
(MyoG and MEF2A/D)***

To generate multi-nucleated myotubes from mono-nucleated myoblasts, the MRFs and MEF2s play an essential synergistic role at various stages of the differentiation programme (Kaushal et al., 1994). Therefore, we postulated that CT-1 might interfere with muscle differentiation through the MRFs and/or MEF2. First, in order to establish that the repression of myogenesis by CT-1 was observed in this analysis the levels of MyHC, a structural marker of muscle differentiation were assessed. As we expected that MyHC accumulated in the solvent treated C2C12 cells at late time points. Conversely, this accumulation of MyHC was largely attenuated in C2C12 cells treated with CT-1 (figure 2). Having determined that myogenesis was repressed by CT-1 at the molecular level, we next assessed the levels of various muscle transcription factors. Under these conditions, the expression of MyoG, a key MRF required for differentiation (Myer et al., 1997) was repressed by CT-1 compared to the solvent treated cells, in which it was strongly induced (figure 2). In addition, MEF2A and MEF2D were also lower in the cells treated with CT-1 (figure 2). These data indicate that CT-1 inhibits myogenic differentiation by interfering with the up-regulation of MyoG and MEF2 factors. Interestingly, MyoD and Myf5 protein levels were relatively not affected by CT-1 suggesting that the lesion in the hierarchical differentiation programme lies between the MRFs required for lineage commitment (MyoD and Myf5) and the pro-differentiation transcriptional regulators (MyoG and MEF2A and MEF2D).

***Transcriptional induction of the myoG promoter by MyoD is repressed by CT-1 signaling***

Since MyoD, along with Myf5, play an early ‘commitment’ role in the myogenic cascade and also play an important role in the induction of the *myoG* gene (de la Serna et al., 2005), we hypothesised that CT-1 might interfere with the *trans*-activation properties of MyoD and therefore its ability to activate *myoG* transcription. To begin to address this hypothesis, we initially measured *myoG* promoter activity using reporter gene assays. In the absence of CT-1, the *myoG* promoter was activated in differentiating C2C12 cells in DM (figure 3). In the presence of CT-1, the activation of the *myoG* promoter was markedly inhibited in a dose dependent manner (figure 3). These data indicate that reduced MyoG levels observed with CT-1 (figure 2) result from a loss of transcriptional induction of the *myoG* locus.

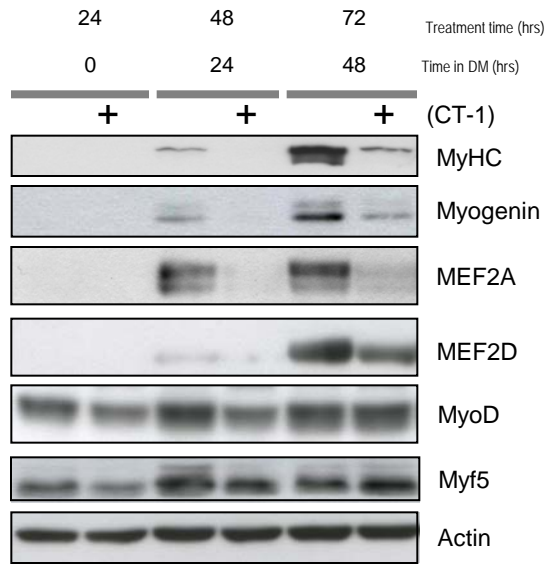

Figure 2

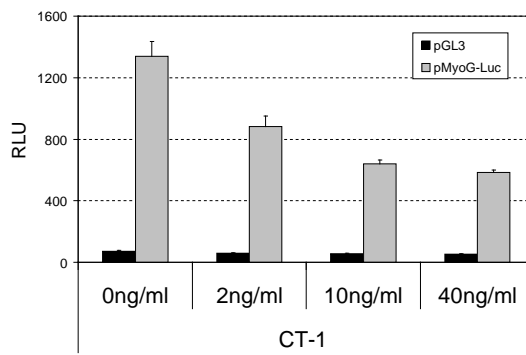

Figure 3

**Figure 2. CT-1 represses the expression of pro-differentiation transcriptional regulators (MyoG and MEF2A/D).** C2C12 cells were induced to differentiate in DM with CT-1 (10ng/ml) or solvent. The cells were maintained in the indicated conditions for specific time periods. Total protein samples were extracted from the cells and equal amounts of total protein (20µg) were subjected to Western blotting analysis. The levels of indicated proteins were assessed by a standard immuno-blotting technique with a specific primary antibody. Actin indicates equal amounts of protein loading into each lane.

**Figure 3. Transcriptional induction of the *myoG* promoter by MyoD is repressed by CT-1.** C2C12 cells were transfected with either pGL3 (empty control) or a Myogenin promoter-luciferase reporter gene construct (pMyoG-Luc), and to monitor transfection efficiency, pCMV-β-gal construct was included in each condition. The transfected cells were maintained for 16 hrs in the indicated concentration of CT-1 or its solvent in DM. Total protein samples were harvested with a luciferase lysis buffer. Luciferase activity in each condition was measured independently and normalized according to β-Galactosidase activity.



### ***Trans-activation properties of the MRFs are repressed by CT-1***

Based on our observation that *myoG* gene transcription was attenuated by CT-1, we next focused on whether MyoD *trans*-activation properties might be altered by CT-1 since MyoD expression levels remained unaffected with CT-1 treatment (figure 2).

The *trans*-activation capacity of MyoD has already been documented to be a heavily regulated aspect of its function, both positively and negatively, by a variety of mechanisms (Kim et al., 2008; Polesskaya et al., 2001; Puri et al., 2001; Reynaud et al., 2000). Bioinformatic analysis of MyoD interacting proteins revealed that MEK1 (Perry et al., 2001) and STAT3 (Kataoka et al., 2003) also share the property that they are known to be activated by phosphorylation in the presence of IL-6 family cytokines in different cell types. Therefore, we first confirmed that expression of CT-1 and its signal transduction receptors, Gp130 and LIFR $\beta$  in C2C12. Endogenous CT-1 and their receptor expression were confirmed by semi-quantitative RT-PCR analysis in the presence or absence of recombinant exogenous CT-1 in the media. We detected their transcripts in C2C12 cells, and their expression levels were not affected in the presence of CT-1 (figure 4A). We then surveyed these signaling molecules first by determining the phosphorylation levels of MEK1 and STAT3 in C2C12 cells acutely (figure 4B) or chronically (figure 4C) treated with CT-1 by Western blotting analysis. Indeed, levels of phosphorylated MEK-1 and STAT3 proteins in C2C12 cells were elevated in the presence of CT-1 compared to those in solvent control cells (figure 4B and C). A previous study indicated that MyoD's transcriptional activation properties can be inhibited by a direct interaction with MEK1 (Perry et al., 2001). Therefore, we sought to test this interaction by co-immuno-precipitation analysis. These experiments

revealed that exogenous expression of an activated form of MEK1 (Act-MEK: MEK1 R4F) and MyoD resulted in co-purification of the two molecules in the same complex, suggesting the possibility that this interaction can occur (figure 4D). In addition we observed that the typical activation of the *myoG* promoter (figure 4E) and MCK promoter (supplemental figure 1) by exogenously expressed MRFs was repressed by CT-1 signaling (recombinant CT-1 or Act-MEK1) (figure 4E). These results further support the idea that MyoD *trans*-activation properties are repressed by CT-1 and that MEK activation is a key component of that repression.

A)

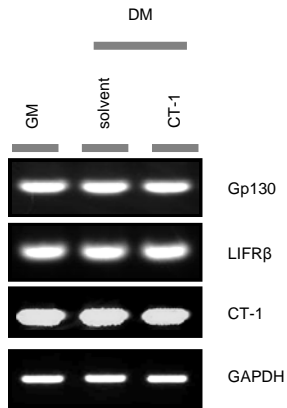

C)

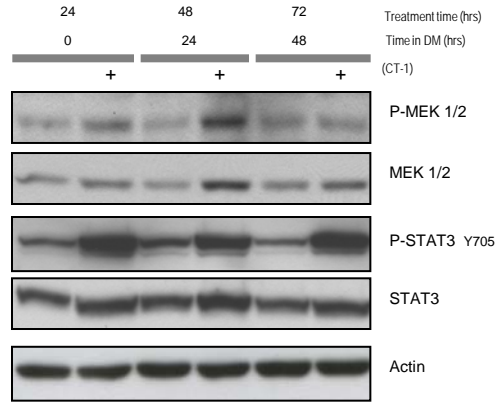

B)

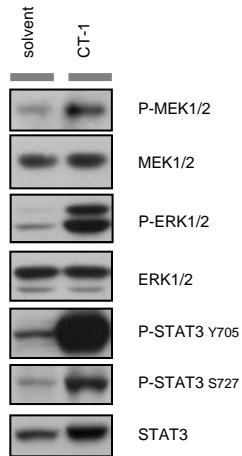

D)

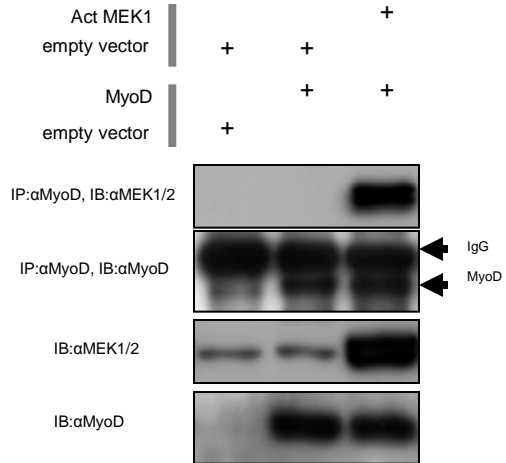

Figure 4

E)

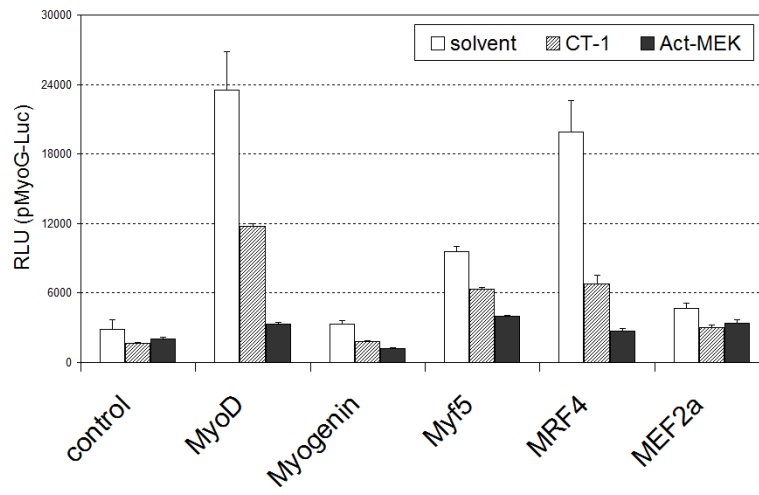

Figure 4

**Figure 4. *Trans*-activation properties of the MRFs are repressed by CT-1.** A) Total RNA was isolated from C2C12 cells in GM (lane 1), DM with solvent (48hrs) (lane 2), and DM with CT-1 (10ng/ml) (48hrs) (lane 3) and subjected to semi-quantitative RT-RCP analysis with indicated gene specific primer pairs. RT-PCR amplified DNA was separated in a TAE/agarose-gel, and EtBr stained DNA was visualised by UV irradiation. GAPDH serves as an internal loading control. B) C2C12 cells were plated at equal density and kept in DM for 16hrs. CT-1 (10ng/ml) or equal volume of the solvent was added to the media. The cells were harvested after 20min of CT-1/solvent addition. Total protein samples were subjected to Western blotting analysis to estimate the levels of indicated proteins. C) Western blotting analysis was performed as described above. However, the cells were maintained in DM with CT-1 or solvent for indicated time periods. D) C3H10T1/2 cells were transfected with combinations of the indicated constructs. Total protein samples were extracted from the cells maintained in DM. Exogenous-expression of MyoD and an activated form of MEK1 was confirmed by immuno-blotting (IB) (10 $\mu$ g loading) with the specific antibodies. An immuno-precipitation (IP) analysis was performed with the total protein extract (250 $\mu$ g) with MyoD antibody (mouse) and proteinG conjugated beads. Precipitated immuno-complex were eluted off the proteinG beads and subjected for an immunoblotting with MEK antibody (Rabbit). Equal amount of IgG loading was monitored with MyoD immuno-blotting with MyoD specific antibody (Rabbit). E) C2C12 cells were transfected with the indicated expression constructs or its empty vector (1 $\mu$ g) and *myoG* promoter-(pMyoG-Luc) promoter-Luciferase reporter construct (0.5 $\mu$ g). In addition, an activated form of MEK1 expression vector (1 $\mu$ g) or its empty vector (for CT-1 and solvent) was included. To monitor transfection efficiency, a pCMV- $\beta$ -Gal construct was also included (0.3 $\mu$ g). After transfection, the cells were maintained in DM containing CT-1 (10ng/ml) or its solvent for 16 hrs. The cells were harvested and subjected to luciferase assay and  $\beta$ -Galactosidase assay.

***CT-1 inhibits the transcriptional properties of the MRFs through activation of MEK signaling***

To directly test the idea that CT-1 activation of MEK is responsible for MyoD *trans*-repression, we utilized MEK specific inhibitors, PD98056 and U0126. First, we reasoned that if MEK activation is absolutely required for CT-1 repression of myogenesis, then we should abrogate CT-1 effects on myogenesis by repression of MEK. In the absence of CT-1 (solvent), C2C12 cells formed multinucleated myotubes, and they accumulated MyHC proteins (brown colour) after 2days in DM (figure 5A). These morphological changes were not observed in the presence of CT-1. However, addition of MEK inhibitors neutralized the inhibitory effect of CT-1 on both myotube formation and MyHC accumulation in a dose dependent manner (3 $\mu$ M vs. 10 $\mu$ M) assessed by immunochemistry (figure 5A). Western blotting analysis of MyHC levels further confirmed the above observations (figure 5B). In agreement with this, a more detailed Western blotting analysis showed that MyoG protein levels were lower in the presence of CT-1, and this inhibitory effect was reversed by MEK inhibition (PD98059), which prevented CT-1 mediated induction of phosphorylation of ERK (a MEK activity indicator). It was noted that as previously reported in different systems (Chen and Sytkowski, 2004; Yip-Schneider et al., 2009), the MEK inhibitor caused hyper-phosphorylation of MEK. However, in the presence of PD98059 upregulation of phospho-ERK by CT-1 was clearly inhibited (figure 5C). Therefore, this MEK inhibitor prevents CT-1 mediated activation of MEK. We also noticed that the MEK inhibitor reversed these CT-1 effects without affecting the phosphorylation levels of STAT3 (figure 5C, see below). Furthermore, luciferase reporter gene assays also showed that

*myoG* promoter activity driven by exogenously expressed MyoD was repressed by CT-1. Furthermore, exogenous expression of an activated form of MEK1 or Raf (components of the MAPK signaling pathway), also repressed *myoG* activation and these effects were reversed in a dose dependent manner by MEK inhibition (figure 5D), and by expression of dominant negative form of MEK1 or Raf1 (figure 5E). Therefore, these data indicate that MEK inhibition ‘rescues’ muscle differentiation from the inhibitory effect of CT-1, both morphologically and biochemically; and repression of MyoD’s *trans*-activation properties by CT-1 is also reversed by MEK inhibition. Taken together, CT-1 represses skeletal myogenic differentiation through interference of the transcriptional activity of MyoD by the activation of MEK signaling.

A)

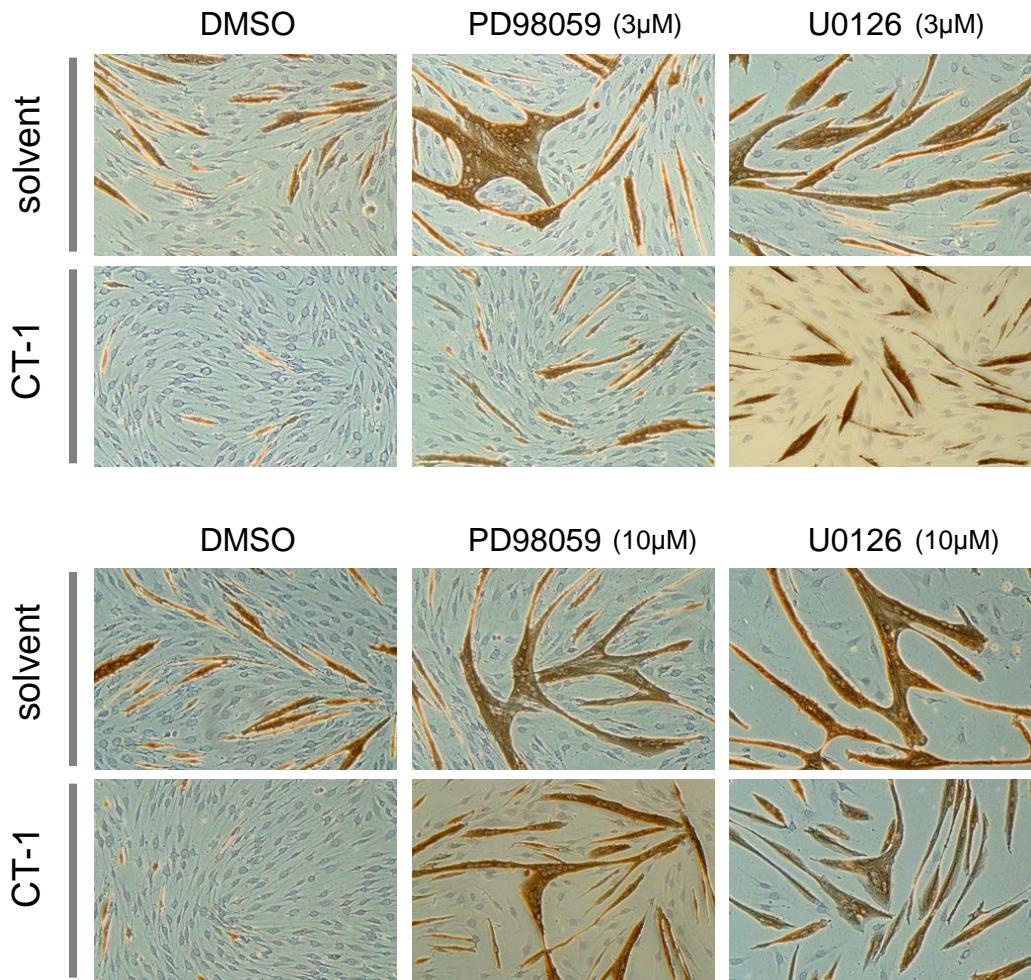

B)

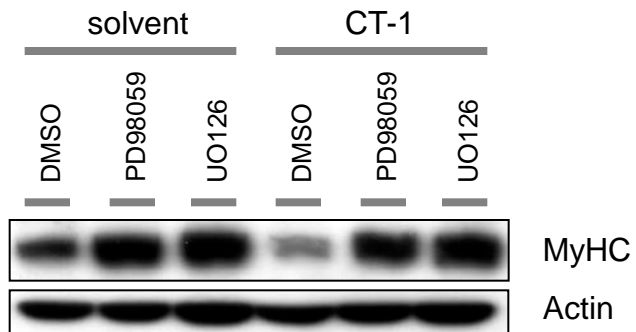
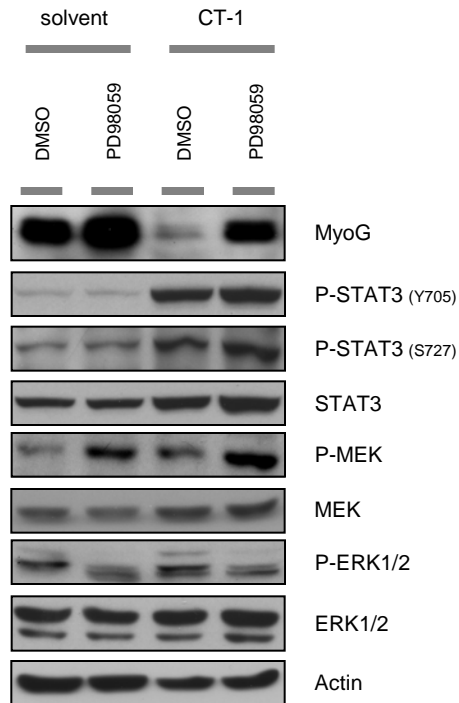

Figure 5



C)



D)

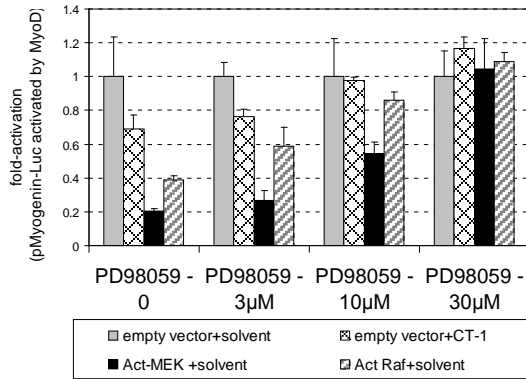

E)

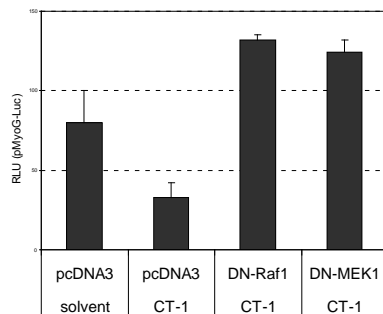

Figure 5

**Figure 5. CT-1 inhibits the transcriptional activity of the MRFs through activation of MEK signaling.** A) C2C12 cells were plated at equal density and induced differentiation transferred into DM upon about reaching confluence. The cells were maintained in indicated concentration of MEK inhibitor (PD98059, U0126, or DMSO; 3 $\mu$ M or 10 $\mu$ M) with without CT-1 (10ng/ml). After 2days in the indicated conditions, the cells were fixed and stained for MyHC detection by immunocytochemistry with MF-20 mouse monoclonal antibody. MyHC protein accumulation was indicated by brown color. The photomicrographs are representative fields. B&C) C2C12 cells were maintained in DM with CT-1 (10ng/ml) and or PD98059 (10 $\mu$ M), or their solvents for 2days (C) or 3days (B) to induce myotube formation. Total cellular proteins were extracted from the cells in each condition. The total protein lysate samples (20 $\mu$ g) were subjected to Western blotting analysis. Actin levels indicate loading of an equal amount of the total protein into each lane. D) C2C12 cells were transfected with a pMyoG-Luc (0.5 $\mu$ g), a MyoD expression vector (1 $\mu$ g), a pCMV- $\beta$ -Gal (0.3 $\mu$ g), and also the indicated kinase expression vector (act.MEK1, act.Raf) or an empty vector (1 $\mu$ g). The transfected cells were maintained in DM containing CT-1 (10ng/ml) or solvent, and the indicated concentration of PD98059 MEK inhibitors for 16hrs. The cells were harvested and subjected to Luciferase assay and  $\beta$ -Gal assay. Luciferase activity was normalized according to the  $\beta$ -galactosidase activity from a co-transfected pCMV- $\beta$ -Gal expression construct by calculating the Relative Luciferase Unit (RLU) for each individual condition, and the fold-activation was calculated with respect to the average RLU of the “empty vector + solvent” at the corresponding concentration of PD98059. E) C2C12 cells were transfected with a pMyoG-Luc (0.5 $\mu$ g), a pCMV- $\beta$ -Gal (0.3 $\mu$ g), and also the indicated kinase expression vector (DN-MEK1, DN-Raf1) or an empty vector (1 $\mu$ g). The transfected cells were maintained in DM containing CT-1 (10ng/ml) or solvent for 16hrs. The cells were harvested and subjected to Luciferase assay and  $\beta$ -Gal assay.

### ***STAT3 activation by CT-1 is not sufficient for inhibition of myogenesis***

We documented that STAT3 is highly phosphorylated at tyrosine 705 (Y705) and serine 727 (S727) in response to CT-1 treatment (figure 4A&B). The Y705 phosphorylation is required for STAT3 dimer formation, nuclear translocation, and transcriptional regulatory activity of STAT3 (Bromberg et al., 1999; Wen et al., 1995; Yu et al., 1995). Since a previous study showed that activated STAT3 can inhibit the transcriptional properties of MyoD (Kataoka et al., 2003), we postulated that STAT3 might also be involved in the repression of MyoD by CT-1 signaling. Western blotting analysis showed that the MEK inhibitor inhibited phospho-ERK1/2 (an indicator of MEK activity) activation by CT-1. However, MEK inhibition had no apparent effect on the phosphorylation levels of STAT3 at Y705 or S727 by acute or chronic CT-1 treatment (figure 5C and 6A). Since MEK inhibition rescues myogenic repression but does not alter STAT3 phosphorylation by CT-1, this indicates that STAT3 activation is not sufficient to inhibit myogenesis. To further address this issue, we next used a pan-JAK kinase inhibitor, P6 (Pedranzini et al., 2006) since STAT3 is phosphorylated by the Gp130/LIFR $\beta$  associated JAK kinases. As previously observed, CT-1 inhibited myotube formation and MyHC accumulation in DM compared to controls (figure 6B). In assessing the dose dependency of the P6, we observed no effect on CT-1 mediated myogenic repression up to a concentration at 250nM. However, at 500nM, P6 clearly neutralised the inhibitory effect of CT-1. Since P6 inhibits tyrosine kinase activity of other kinases at high levels (Thompson et al., 2002), we assessed the inhibitory effect of P6 on the phosphorylation levels of, STAT3, MEK1/2, and ERK1/2 by Western blotting analysis. As is claimed for this inhibitor, increased phosphorylation of STAT3

(Y705 and S727) by CT-1 was inhibited by P6 in a dose dependent manner (figure 6C). However, at a high concentration (500nM), P6 also repressed phosphorylation of ERK1/2 in the presence of CT-1. Since significant repression of phosphorylation of STAT3 was seen with the P6 inhibitor at low concentrations (up to 250nM), but such concentrations had no effect in reversing CT-1 effects on myogenesis, we conclude that STAT3 activation by CT-1 is not sufficient to inhibit myogenesis. In agreement with the above results, MyoD driven *myoG* promoter activity was clearly inhibited in the presence of CT-1 (figure 6D). However, at any concentration tested, P6 had little effect on CT-1's inhibitory effect. In addition, exogenous expression of constitutively active (A662C and N664C) (Bromberg et al., 1999), phospho-mimetic mutant (Y705D and S727D) or dominant negative forms of STAT3 (S705F and S727A) (Kaptein et al., 1996) had no apparent effect on myogenesis phenotypically and biochemically in the presence of CT-1. Therefore, these results indicate that inhibition of MEK1/2 activity but not JAK activity is required for reversing the inhibitory effect of CT-1 on myogenesis. Taken together, we conclude that CT-1 inhibits skeletal muscle differentiation primarily through activation of MEK and, surprisingly, does not require STAT3 activation.

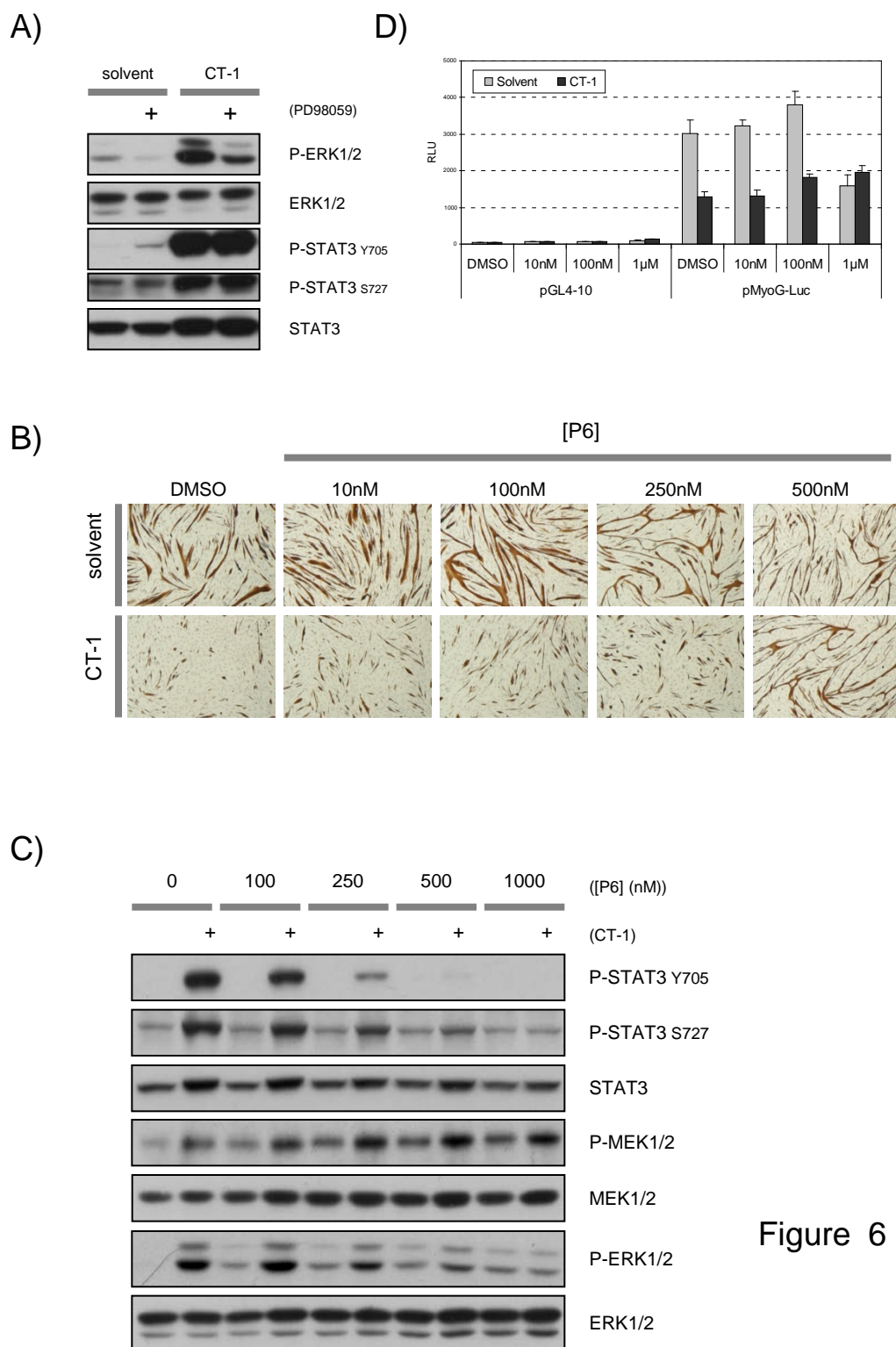

Figure 6

**Figure 6. STAT3 activation by CT-1 is not sufficient for inhibition of myogenesis.** A) C2C12 cells were plated at equal density maintained in DM. A MEK inhibitor (PD98059 (10 $\mu$ M)) or DMSO was added 30min before the addition of CT-1 (10ng/ml) or its solvent. After 20 min of CT-1 or solvent treatment, the cells were harvested, and total protein samples were extracted for each condition. The protein samples (20 $\mu$ g) were subjected to Western blotting analysis. B) An equal number of C2C12 cells were plated and maintained in DM containing CT-1 (10ng/ml) or its solvent, in addition, the indicated concentration of pan-JAK kinase inhibitor, P6, was included in the DM. The cells were fixed after maintained in the DM for 3days, and accumulation of MyHC was visualized by immunocytochemistry. The brown color indicates MyHC accumulation in the cells. The photomicrographs are representative fields of each condition. C) C2C12 cells were plated at equal density and maintained in DM for 16 hrs. Thirty min before adding CT-1 (10ng/ml) or its solvent, the cells were treated with indicated concentration of P6 (pan-JAK kinase inhibitor). After 20 min of CT-1 or solvent addition to the media, the cells were harvested. Total protein samples were extracted from the cells in each condition, and equal amounts of the protein (20 $\mu$ g) was subjected for Western blotting analysis. D) C2C12 cells were transfected with an either pMyoG-Luc or pGL4-10 (0.5 $\mu$ g), and a MyoD expression vector (1 $\mu$ g), a pCMV- $\beta$ -Gal (0.3 $\mu$ g). The transfected cells were maintained in DM containing CT-1 (10ng/ml) or solvent, and the indicated concentration of P6 pan-JAK inhibitor for 16hrs. The cells were harvested and subjected to Luciferase assay and  $\beta$ -Gal assay.

***CT-1 increases the number of muscle precursor cells and delays regeneration of damaged muscle in vivo***

To test the effect of CT-1 on *in vivo* skeletal muscle function, we utilized systemic delivery of a CT-1 expressing adenovirus, AdCT-1 (Bordet et al., 1999). AdCT-1 infection causes accumulation of CT-1 protein in cell-culture medium (figure 7A), and AdCT-1 injection leads to accumulation of CT-1 in liver and skeletal muscle (figure 7B). Although it did not lead to gross morphologic alterations in skeletal muscle (figure 7C), we noted a significant increase in the number of DAPI positive nuclei per myofiber following exposure to AdCT-1 compared to control injected animals (Figure 7C&D;  $P < 0.05$ ). This observation suggested that CT-1 exposure represses differentiation leading to an increase in the number of undifferentiated myogenic precursors *in vivo*, similar to the effect elicited in C2C12 myoblast cell cultures. To test the possibility that CT-1 elicited an expansion of the myoblast/muscle precursor cell population, we also investigated the impact of CT-1 administration on the endogenous skeletal muscle progenitor pool. Skeletal muscle contains a population of cells that retain stem cell/progenitor like characteristics and these cells can be isolated based on Hoechst dye exclusion, referred to as side population (SP) cells (Asakura et al., 2002; Jackson et al., 2002; Muskiewicz et al., 2005). Skeletal muscle derived muscle progenitor cells from CT-1 injected animals were substantially increased compared to the number of progenitor cell colonies derived from control injected animals (10.6 vs 1.0;  $P < 0.05$ ;  $n=7$ ). Based on our *in vitro* observations, we postulated that CT-1 exposure might also limit the differentiation of myoblasts *in vivo*. To test this supposition we induced muscle regeneration via cardiotoxin (CTX) injection in animals

that received either AdCT-1 or the control adenovirus. CTX injury elicits a well defined response in which the myofibers are damaged, followed by expansion and differentiation of myogenic precursors to renew or replace the lost myofibers. Interestingly, CT-1 injected animals displayed a limited regeneration, exemplified by a marked reduction in the number of myofibers with centrally located nuclei and an expansion of mononucleated cells associated with regenerating myofibers compared to controls (Figure 7E). These results suggest that CT-1 targets myoblasts/muscle progenitor cells *in vivo* and actively represses the differentiation program. Taken together, our results implicate a role for CT-1 in the maintenance of the undifferentiated state in muscle progenitor cells.



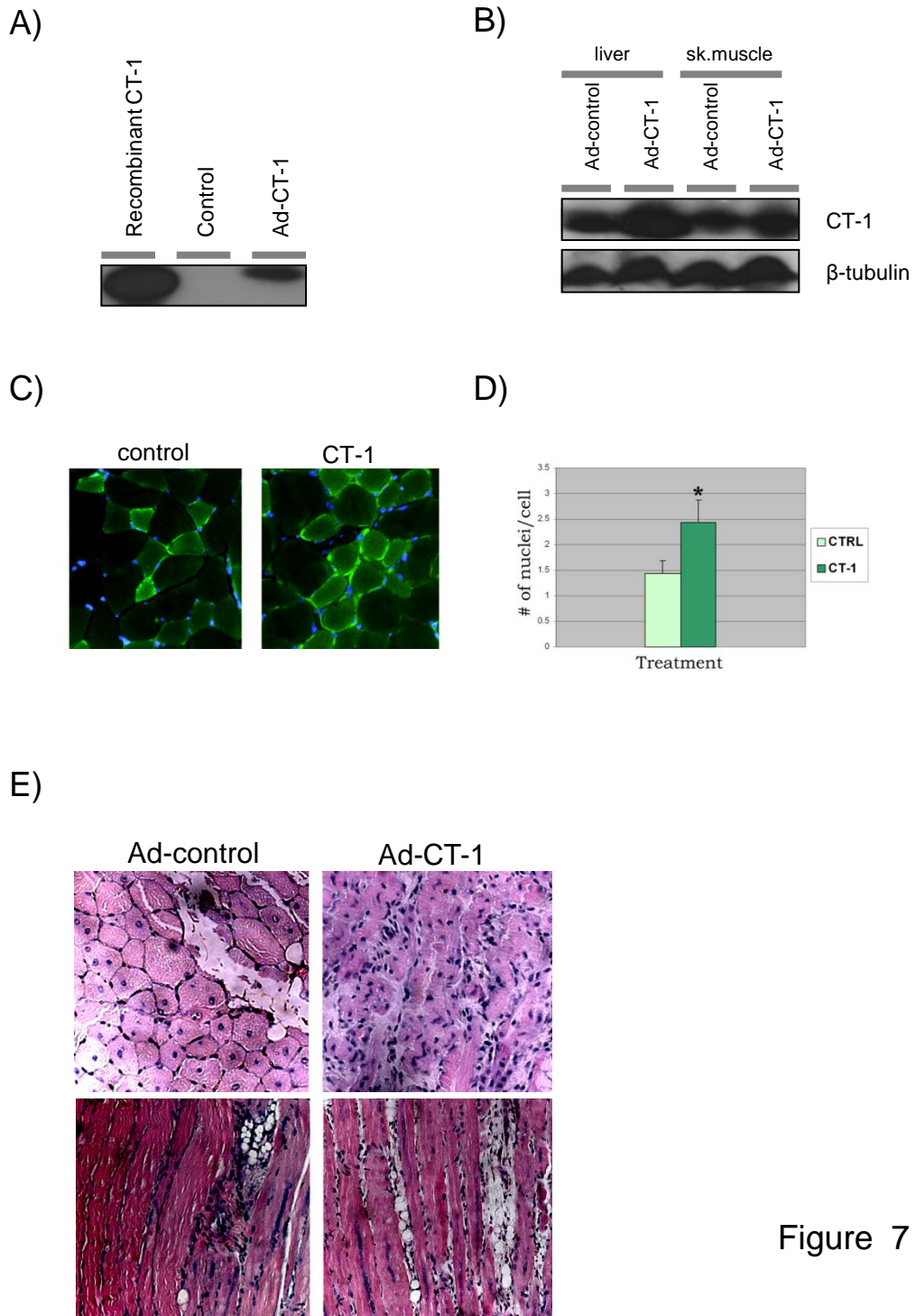

Figure 7

**Figure 7. CT-1 delays regeneration of damaged skeletal muscle *in vivo*** A) Immunoblotting was used to verify the efficacy of Adenovirus CT-1 production. Recombinant CT-1 protein (100ng) was used as a positive control, as well as media from CT-1 adenovirus infected myocytes. At 72hrs post-infection, the media from the treated and untreated cells was collected and subjected to Western blotting analysis with a CT-1 antibody. B) At 7 days post-injection, skeletal muscle (sk.muscle) and liver samples were excised from adenovirus injected mice. Frozen tissue was homogenized and a total of 300µg of protein was electrophoresed on a 15% SDS-PAGE. An equal protein loading was verified by Western blotting analysis using β-tubulin specific antibody C) At 7days post-injection, skeletal muscle was excised, fixed then embedded in paraffin, and sectioned at 10µm. These sections were counterstained with haematoxylin and eosin to visualize the nuclei and cytoplasm. For immuno-histological detection of β-actinin, the sections were incubated with β-actinin antibody (Abcam), then incubated in donkey-anti-goat CY3 antibody (Chemicon) and finally counterstained with DAPI (Sigma). The micrographs were representative fields D) 5 fields of view per section and 5 sections per TA muscle were analysed. Differences between Ad-CT-1 and Ad-CTRL injected samples were evaluated for statistical significance using one tailed, unpaired Student's *t* test. Differences were considered statistically significant at a p value less than 0.05. (n=3)

E) B6C3F1 mice were subject to systemic delivery of the CT-1 adenovirus. The injections were administered via intra-cardiac chamber delivery with 50µL of Ad-CT-1 at a concentration of  $3.0 \times 10^8$  PFU/mL (n=3). A control group of B6C3F1 mice were injected with 50 µL Ad-CTRL at a similar concentration (n=3). In a separate group of animals, cardiotoxin was used to induce muscle injury immediately prior to AdCT-1 and Ad-CTRL injection (n=3 for each group). 25µl of 10µM cardiotoxin (Latoxan) was injected directly into the TA muscle. 5 fields of view per section and 5 sections per TA muscle were analysed. The micrographs were representative views. During post-recovery, mice were monitored closely for weight loss, dehydration and cardiac distress.

## Discussion

In this study, we have characterised CT-1 as a potent inhibitory cytokine for the skeletal muscle differentiation program. We document that CT-1 activates MEK, which functionally abrogates the transcriptional activation properties of MyoD, a master regulator of myogenesis. Repression of this core muscle transcriptional network extinguishes induction of the *myoG* gene, an essential downstream regulator of the muscle differentiation program. Inhibition of muscle differentiation by CT-1 is MEK dependent since well-established MEK specific inhibitors, PD98059 and U0126 reverse CT-1's inhibitory effects on myogenesis both biochemically and phenotypically. Conversely, even though STAT3 is highly phosphorylated in the presence of CT-1, our experiments indicate that the phosphorylated STAT3 at Y705 and S727 is not sufficient to inhibit myogenesis. Thus, we conclude that CT-1 mediated inhibition of myogenesis requires MEK activation which subsequently interferes with the *trans*-activation properties of MyoD. This repression is independent of JAK-STAT signaling since pharmacological blockade of this pathway has no effect on the repression of myogenesis by CT-1.

### ***Is MEK-ERK signaling a convergent regulatory nexus for cytokine mediated myogenic repression?***

Several cytokines and growth factors such as FGF and EGF inhibit myogenesis through activation of MEK-ERK signaling. There are however some exceptions, such as IGF and Insulin, which activate MEK-ERK but paradoxically enhance muscle differentiation under some conditions. Since IGFs and Insulin also activate the Phosphatidy Inositol 3-Kinase (PI3K)-Akt pathway, and inhibition of PI3K or Akt neutralises their effect on

myogenesis (Xu and Wu, 2000), it is likely that inhibition of differentiation is a “ground state” which can be overcome by pro-myogenic signals such as those mediated by Akt (Serra et al., 2007). This is essentially the sequence of events during ontogeny in which the muscle progenitor cells are held in an undifferentiated state until appropriate cues and conditions for differentiation are established. Thus, the dominance of pro-myogenic over inhibitory signals is a prerequisite for differentiation to occur. There is now substantial evidence suggesting that MEK activation is a point of convergence for several growth factors in repressing myogenesis (Page et al., 2004; Ramocki et al., 1997; Rommel et al., 1999). Evidence to date indicates that an activated nuclear MEK interacts with the MRFs and inhibits their transcriptional activation properties (Perry et al., 2001). The MRFs have consensus MAPK phosphorylation sites. However, MEK is capable of inhibiting the activity of a mutated form of Myf5, which does not have intact ERK phospho-acceptor sites. Therefore, the phosphorylation of the MRFs by MEK is not necessarily required for the repression (Winter and Arnold, 2000). Recently, transcriptional regulators have been found to recruit kinases in a stable manner to target promoters to phosphorylate other components at the transcriptional machinery (Puri et al., 2001). Therefore, it is possible that the recruitment of kinases to muscle promoters is required for the inhibitory effects on differentiation. This is consistent with our data which indicates that the physical association of MyoD with MEK is crucial for the anti-myogenic activity of CT-1.

Interestingly, another member of the IL-6 cytokine family, LIF, was shown to inhibit skeletal myogenesis *in vitro* (Jo et al., 2005). In agreement with our observations, LIF mediated repression was also correlated with MEK-ERK pathway activation (Jo et al., 2005). LIF and CT-1 transduce signals in a similar manner through  $\beta$ -receptors such as Gp130 and

LIFR $\beta$ . Prior to binding to the  $\beta$ -receptors, at least some of the IL-6 family cytokines bind to ligand specific  $\alpha$ -receptors, and expression levels of the  $\alpha$ -receptor in some cell types is known to regulate the sensitivity of the responsiveness to the specific ligand. Although LIF appears to bind  $\beta$ -receptors directly, CT-1 forms a complex with an  $\alpha$ -receptor (Heinrich et al., 2003). However, this receptor has so far not been fully characterized, so a tissue specific role of this receptor has yet to be determined. In C2C12 skeletal muscle cells, we have confirmed that Gp130 and LIFR $\beta$  are expressed, and further characterization of the CT-1  $\alpha$ -receptor will delineate the precise receptor system. The convergence of LIF and CT-1 on MEK-ERK signaling suggests that this is a common nodal point for Gp130 linked cytokines.

CT-1 was originally isolated as a hypertrophic factor for cardiomyocytes *in vitro* (Pennica et al., 1995). Chronic administration of CT-1 into the mouse, indeed, causes hypertrophic hearts and also increases the size of liver, kidney, and spleen. This is, at least partially, the result of induction of the Vascular Endothelial Growth Factor (VEGF) gene in cardiac myocytes through activation of the Gp130-JAK-STAT3 pathway (Jin et al., 1996). In addition, CT-1 activates MAPK pathways and the Akt-PI3 kinase pathway and protects cardiomyocytes from apoptosis (Brar et al., 2001; Liao et al., 2002; Sheng et al., 1997). One of the target genes of CT-1 in this cardio-protective role is the Small Proline-Rich Repeat protein-1A (SPRR1A) gene. CT-1 induces SPRR1A expression transcriptionally through activation of MEK-AP-1 and CCAAT/Enhancer-Binding Protein- $\beta$  (C/EBP $\beta$ ) pathways. This SPRR1A gene induction by CT-1 is independent of STAT3 activity but blunted by small chemical inhibitors of MEK activity, PD98059 and U0126 (Pradervand et al., 2004). Therefore, in other systems, CT-1 activates MEK kinases and regulates their down stream transcription factors. In C2C12 cells, we observed that the SPRR1A promoter was also up-

regulated by CT-1 or an activated form of MEK, and this induction was dependent on MEK activation. However, *SPRR1A* over-expression does not inhibit myogenesis suggesting that this CT-1 target gene is not responsible for myogenic repression. Our observations are discordant with a previous study, in which it was shown that activated STAT3 and MyoD physically interact and functionally antagonise each other by competing for limited amounts of co-activators, such as P300 and PCAF (Kataoka et al., 2003). We document that the pan-JAK inhibitor, P6, reduced the phosphorylation levels of STAT3 (Y705 and S727) by CT-1 but had little effect on myotube formation or MyoD's transcriptional activity at the concentration at which P6 inhibits phosphorylation of STAT3. Therefore, while we do not completely rule out the possibility that the inhibition of MyoD activity may be partly mediated by STAT3, we conclude that activation of MEK but not STAT3 is the primary molecular event responsible for CT-1's inhibitory effect on myogenesis. Further support for this idea was recently provided by the observation that STAT3 and JAK2 were shown to be required for muscle differentiation C2C12 (Wang et al., 2008). Thus, the notion that STAT3 also functions in an inhibitory manner is unlikely. In addition, we observed that a well established JAK2 inhibitor, AG490, inhibited muscle differentiation in a dose dependent manner as previously reported (supplemental figure 2A) (Wang et al., 2008). However, this JAK2 inhibitor surprisingly had no effect on phosphorylation of STAT3 by CT-1 (supplemental figure 2B). Therefore, the JAK/STAT pathway does not appear to play a repressive role during myogenesis.

Given the temporal and spatial patterns of CT-1 expression during myogenesis, a pervasive consideration is whether CT-1 plays a role in the maintenance of the undifferentiated state or even pluripotency of progenitor cells in an autocrine or paracrine

manner. Since CT-1 is expressed in skeletal muscle at key times during embryogenesis, and, as we observed, has a potent role in which it can reversibly repress myogenesis *in vitro* and delay regeneration *in vivo*. The observed *in vitro* and *in vivo* role of CT-1 in skeletal muscle cells defines it as a potential target of therapeutic interventions in which small molecule cell permeable inhibitors can be used to manipulate pro- and anti-differentiation pathways. Moreover, knowledge of these pathways could be instrumental in *ex-vivo* programming of progenitor cells which may have critical implications for a variety of cellular based muscle therapies.

In summary, we have documented that the CT-1 cytokine has a potent repressive effect on skeletal myogenesis *in vivo* and *in vitro*. This effect, which is reversible, requires MEK-ERK signaling and, surprisingly, does not require STAT3 activation. The expression patterns of CT-1 and its *in vivo* and *in vitro* properties described here make it a viable candidate to play a role in the maintenance of the undifferentiated muscle progenitor cell state in embryonic and post-natal skeletal muscle.

### **Conflict of interest**

The authors declare no conflict of interest.

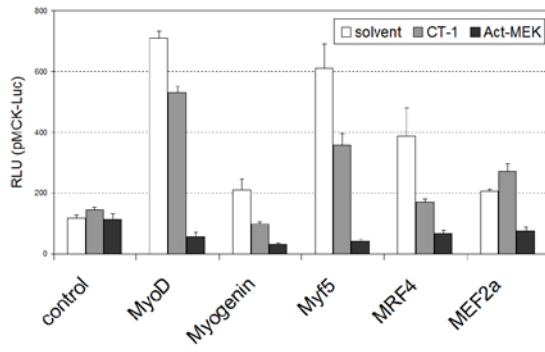

Supplemental figure 1

A)

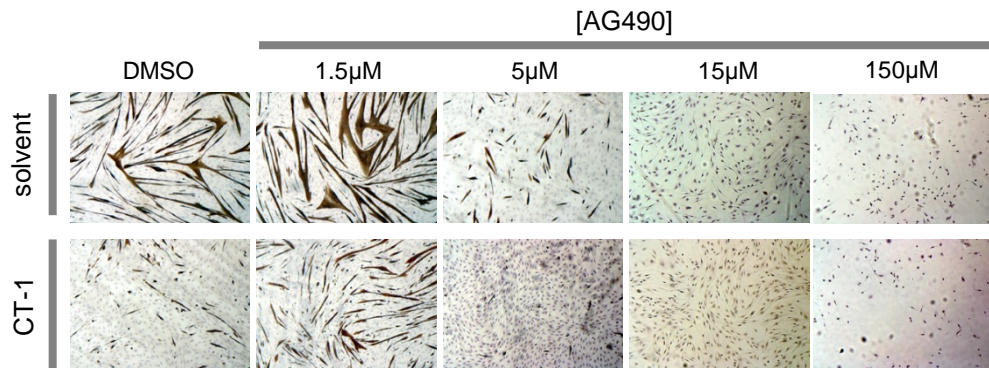

B)

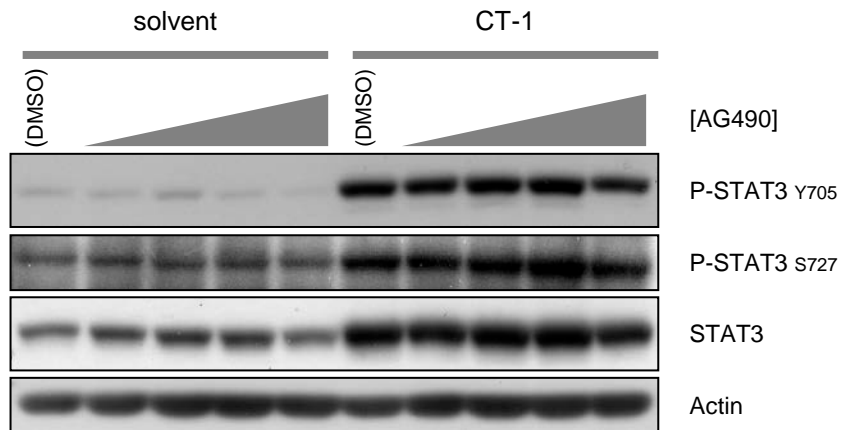

Supplemental figure 2



## **Chapter IV: Signal Dependent Fra-2 Regulation in Skeletal Muscle Reserve and Satellite Cells**

Published in “Cell death and disease”  
(2013), vol 4, e6921

Experimental design and drafting manuscript  
Nezeka S Alli and Dr. John C McDermott

Conducting experiments

Nezeka S Alli; (figure 1A, 1B, 1C, 1D, 2A, 2B, 3A, 3B, 3C, 3D, 3E, 4A, 4B, 5A, 5B, 6C, 8, S1, S2, S3)

Dr. Eric C Yang; (figure 2C)

Dr. Henry Collins-Hooper and Dr. Ketal Patel; (figure 6A, 6B, 7)

## Signal Dependent Fra-2 Regulation in Skeletal Muscle Reserve and Satellite Cells

Nezeka S. Alli<sup>1,2,3</sup>, Eric C. Yang<sup>4,7</sup>, Tetsuaki Miyake<sup>1,8</sup>, Arif Aziz<sup>1,9</sup>, Henry Collins-Hooper<sup>5</sup>, Ketan Patel<sup>5</sup>, John C. Mc.Dermott<sup>1,2,3,6\*</sup>

<sup>1</sup>Department of Biology, York University, 4700 Keele St. Toronto, Ontario, M3J 1P3, Canada

<sup>2</sup>Muscle Health Research Centre (MHRC), York University, 4700 Keele St, Toronto, Ontario, M3J 1P3, Canada

<sup>3</sup>Centre for Research in Biomolecular Interactions (CRBI), 4700 Keele St, Toronto, Ontario, M3J 1P3, Canada

<sup>4</sup>Sunnybrook Health Sciences Centre, 2075 Bayview Ave, Toronto, Ontario, M4N 3M5, Canada

<sup>5</sup>School of Biological Sciences, Hopkins Building, University of Reading, Whiteknights Campus, Reading, Berkshire, RG6 6UB, UK.

<sup>6</sup>Centre for Research in Mass Spectrometry (CRMS), York University, 4700 Keele St, Toronto, Ontario, M3J 1P3, Canada

Running Title: Fra-2 regulation in skeletal muscle cells

\*Corresponding Author:

John C. McDermott,

247 Farquharson Building, York University, 4700 Keele St, Ontario Canada, M3J 1P3

Phone: 416-736-2100 ex 30389

Fax: 416-736-5698

e-mail: [jmcderm@yorku.ca](mailto:jmcderm@yorku.ca)

## **Summary**

Activator protein 1 (AP-1) is a ubiquitous transcription factor that paradoxically also has some tissue specific functions. In skeletal muscle cells, we document that the AP-1 subunit, Fra-2, is expressed in the resident stem cells (Pax7 positive satellite cells) and also in the analogous undifferentiated “reserve” cell population in myogenic cultures, but not in differentiated myofibre nuclei. Silencing of Fra-2 expression enhances the expression of differentiation markers such as muscle creatine kinase (MCK) and myosin heavy chain (MyHC) indicating a possible role of Fra-2 in undifferentiated myogenic progenitor cells. We observed that Fra-2 is a target of cytokine mediated ERK 1/2 signalling in cultured muscle cells and extensive mass spectrometry and mutational analysis identified S320 and T322 as regulators of Fra-2 protein stability. Interestingly, Fra-2 S320 phosphorylation occurs transiently in activated satellite cells and is extinguished in Myogenin positive differentiating cells. Thus, cytokine mediated Fra-2 expression and stabilization is linked to regulation of myogenic progenitor cells having implications for the molecular regulation of adult muscle stem cells and skeletal muscle regeneration.

## **Keywords**

Activator protein-1, Phosphorylation, myogenesis, satellite cells, ERK 1/2 signalling

**Abbreviations:** AP-1, activator protein-1; CT-1, cardiotropin-1; EDL, extensor digitorum longus; ERK 1/2, extracellular signal-regulated kinase; MAPK, mitogen activated protein kinase; MB, myoblast, MCK, muscle creatine kinase; MRF, myogenic regulatory factor; MT, myotube; MyHC, myosin heavy chain.

## **Introduction**

Skeletal muscle development (myogenesis) is a complex and crucial process in all metazoan embryonic development involving temporal and spatial coordination of a network of myogenic transcription factors (Buckingham et al., 2003). In particular, members of the myogenic regulatory factor (MRF) family have a prominent role during myogenesis. These transcription factors include commitment factors MyoD and Myf5, and differentiation markers MRF4 and Myogenin (Braun et al., 1994; Cossu et al., 1996; Kablar et al., 1999; Wright et al., 1989). Other transcription factors also play obligatory roles in regulating skeletal myogenesis such as members of the myocyte enhancer factor 2 (MEF2) (Edmondson et al., 1994; Novitch et al., 1999; Ornatsky et al., 1997; Wang et al., 2001), Six, and Smad families (Kollias et al., 2006; Miyake et al., 2010). Along with the tissue restricted myogenic factors, contributions of more ubiquitous transcriptional regulators at muscle promoters also impinge on the precise combinatorial regulation required for orchestration of the myogenic program (Andreucci et al., 2002). Previously we have implicated activator protein-1 (AP-1) as one example of this class of ubiquitous transcription factors that contribute, in concert with the MRFs, to the regulation of muscle gene expression.

AP-1 is a transcription factor complex comprising of Jun (c-Jun, JunD, JunB) homodimers or Jun-Fos (Fra-1, Fra-2, c-fos, FosB) heterodimers. AP-1 complexes have been classically associated with cancer progression and are characterized as proto-oncogenes (Bossy-Wetzel et al., 1992; Lian et al., 1991). However, they are ubiquitously expressed and have a wider role than initially anticipated in the control of tissue specific genes. In myogenic cells, previous data has suggested that AP-1 is a

negative regulator of differentiation based on observations that c-Jun dimerizes with MyoD to inhibit its activity (Bengal et al., 1992) and also MyoD is required to down regulate c-Fos for differentiation to proceed (Trouche et al., 1993). The AP-1 subunits are well defined nuclear targets of signalling pathways active in skeletal muscle such as mitogen activated protein kinases (MAPK) and ERK 1/2 is a known upstream kinase of Fos family members (Acquaviva et al., 2001; Gruda et al., 1994).

The AP-1 complexes that bind DNA in skeletal muscle cells was previously examined by us and it was found that Fra-2 was a primary component of the myogenic AP-1 DNA binding complex (Andreucci et al., 2002). Thus, we sought to assess the role of Fra-2 and determine the mechanism by which it is regulated during myogenesis. Cardiotrophin-1 (CT-1), is a cytokine that potently inhibits skeletal muscle differentiation by activating MEK 1/2 -ERK 1/2 signaling (Miyake et al., 2009). Using a mass spectrometry based approach along with mutational analysis we report two regulatory ERK 1/2 MAPK phosphorylation sites on Fra-2 in response to CT-1- ERK signaling. The two Fra-2 phosphorylation sites, S320 and T322, contribute to a potentiation in Fra-2 protein stabilization. These sites are phosphorylated in response to growth factors such as CT-1. Stabilization of Fra-2 by phosphorylation results in an overall inhibition of differentiation while loss of function studies using Fra-2 siRNAs demonstrated that reduced Fra-2 levels potentiate expression of muscle specific marker genes such as muscle creatine kinase (MCK) and myosin heavy chain (MyHC). Interestingly, separation of reserve cells and myotubes (MT) in a differentiated culture revealed differential expression of Fra-2. Fra-2 expression was largely restricted to reserve cells during differentiation and further studies indicate that Fra-2 was expressed

and phosphorylated in activated muscle satellite cells, the adult muscle stem cell progenitor population.

## **Materials and Methods**

***Cell culture.*** The C2C12 cell line was purchased from American Tissue Culture Collection (ATCC). Cells were maintained in growth media (GM) consisting of 10% foetal calf serum (FBS) in Dulbecco modified eagles medium (DMEM) (Gibco) supplemented with 2mM L-glutamine (Invitrogen) and 100µg/ml penicillin/streptomycin (Invitrogen). Cells were induced to differentiate at 80% confluency using differentiation media (DM) consisting of 2% horse serum in DMEM supplemented with 2mM L-glutamine (Invitrogen) and 100µg/ml penicillin/streptomycin (Invitrogen).

***Fractionation of Myotubes and Reserve cells.*** C2C12 cells were allowed to differentiate for 96 to 144h in DM. Media was removed from the plate and cells were washed twice with cold 1X PBS (phosphate buffered saline) followed by addition of 1ml of 0.125% trypsin diluted in 1X PBS. Cells were inspected using an Axiovert 25 (Carl Zeiss) light microscope for MT contraction. On visual observation of MT contracture trypsin was removed and 1ml of cold 1X PBS was added. The plate was gently swirled to dislodge MT which were then collected in a 1.5ml tube. The plate was further washed with cold 1X PBS to remove residual MT after which the reserve cells (which remained on the plate) were scraped off into a 1.5ml tube.

**Cloning and mutagenesis.** The Fra-2 ORF was cloned into the pGEX-4T vector, pcDNA3 (Invitrogen) or in frame downstream of an EGFP tag. Site directed mutagenesis was carried out using the QuikChange Multi-site directed mutagenesis kit (Stratagene) for construction of the Fra-2 phospho-mutations, following manufacturers protocol.

**Antibodies and other reagents.** The following antibodies were purchased from SantaCruz: Fra-2 Q-20 (sc-604), Fra-2 L-15 (sc-171), c-Jun (H-79) (sc-1694), Actin (I-19) (sc-1616-R), dsRed (C-20) (sc-33354), MyoD (M-318) (sc-760), ERK1 (C16) (sc-93), donkey anti-goat IgG-HRP (sc-2020). The following antibodies were obtained from Cell Signalling: MEK 1/2 (#9122), phospho-MEK 1/2 (#9121), phospho-p44/p42 MAPK (Thr202/Tyr204) (#9106), phospho-Fra-1 (#3880), phospho-c-Jun (#9261). Myogenin (clone F5D) and MyHC (clone MF20) monoclonal antibodies were derived from hybridomas provided by the Developmental Studies Hybridoma Bank (DSHB). Goat anti-rabbit IgG-HRP (170-6515) and goat anti-mouse IgG-HRP (170-6516) were from BioRad Laboratories. Lyophilized CT-1 (438-CT) was obtained from R and D systems. PD98059 (#9900) was purchased from Cell signalling. MG132 (C2211) was from Sigma-Aldrich.

**Transfection.** Myoblasts were seeded at a density of  $12.5 \times 10^3$  cells/well for 6-well plates and  $1.0 \times 10^5$  cells/plate for 100 mm plates. Transfections were carried out using standard Hepes buffered saline (HEBS)-CaCl<sub>2</sub>-phosphate mediated transfection method using a total of 5µg of DNA for 6 well plates and 25µg for 100 mm plates. Expression

vectors used included pcDNA3\_Fra-2, pcDNA3\_Fra-2 DEF, dsRed2, and Fra-2 S120A, S230A, S320A, Fra-2 S120A, S200A, S230A, Fra-2 S120A, S200A, S230A, S320A, Fra-2 S320A, Fra-2 T322A, Fra-2 S320A T322A, Fra-2 S320D, Fra-2 T322D. Luciferase reporter constructs include pGL-4-10\_luc, pGL4-10\_myogenin\_luc and pRL\_Renilla (Promega). Three siRNAs (Mission® siRNA ID's: SASI\_Mm01\_00201000, SASI\_Mm01\_00201002, SASI\_Mm01\_00201004) targeting mouse Fra-2 were obtained from Sigma-Aldrich. They were reconstituted in nuclease free water (Ambion) and 15nM of siRNA was transfected into cells using lipofectamin (Invitrogen) in serum-free media.

***Protein extraction.*** For total cell lysate analysis, media was aspirated from plates and cells were washed twice with cold 1X PBS and scraped into 1.5 ml tubes. Cells were pellet at 1.5 x1000g and resuspended in NP-40 lysis buffer (50 mM Tris, 150 mM NaCl, 0.5% Nonidetp-40 (NP-40) 2 mM EDTA) 100 mM NaF and 10 mM Na pyrophosphate) supplemented with protease inhibitor cocktail (Sigma, P8340), 1mM NaV (Bioshop) and 1mM PMSF (Sigma). Cytosolic and nuclear extraction was performed using a NE-PER nuclear protein extraction kit (Thermoscientific, #78833) Protein concentrations were determined using the Bradford protein assay (BioRad).

***Luciferase reporter gene assays.*** Media was aspirated from cells grown in 6-well dishes and cells were washed twice with cold 1X PBS. Cells were scraped in Luciferase lysis buffer (20mM Tris pH 7.4 0.1% TritonX) and lysate was transferred to 1.5ml tubes. Samples were briefly vortexed and spun at maximum speed for 15 min at



4°C. Samples were aliquoted into tubes and Luciferase assay substrate (E1501) or Renilla assay substrate (E2820), purchased from Promega, was added and Luciferase and Renilla enzymatic activity was measured on a luminometer.

***IP and CIP treatment.*** Immunoprecipitation was carried out using the ExactaCruz F kit (SantaCruz, sc-45043) according to manufactures' protocol. Briefly, 40µl of IP matrix was incubated overnight with 5µg of Fra-2 primary antibody. The IP matrix-antibody complex was washed three times with cold 1X PBS and incubated overnight with 120µg of total cell lysate. IP matrix-antibody-protein complex was washed three times with cold 1X PBS supplemented with protease inhibitor cocktail (Sigma, P8340), 1mM NaV (Bioshop) and 1mM PMSF (Sigma), before incubation with CIP (NEB, M0290S) or its buffer. 2X SDS sample buffer was added and samples were boiled and loaded on a 10% SDS page gel and analyzed by Western blotting.

***Western blotting.*** A total of 20µg of total lysate was resolved on 10% (or 8%) SDS-PAGE gels and transferred onto Imobolion-P or Immobilon-FL PVDF membranes (Millipore). Membranes were blocked using 5% milk in 1X PBS or 1X Tris buffer saline (TBS) containing 0.05% tween20 (TBS-T) and incubated with primary antibodies overnight at 4°C. Membranes were washed with 1X PBS or 1X TBS-T and incubated with secondary antibody then washed with 1 X PBS or 1X TBS-T. Immunoreactive bands were detected using ECL Chemiluminescence reagent (GE Healthcare).

***GST-purification.*** Human full length ORF of Fra-2 was cloned in frame into a pGEX 4T-1 vector, which contains glutathione S-transferase (GST) to generate a GST-Fra-2 fusion protein. GST-Fra-2 was transformed in BL-21 competent *E. coli* cells. Isopropyl  $\beta$ -D-1-thiogalactopyranoside (IPTG) (Bioshop, IPT001) was used to induce expression of the fusion protein. Cells were harvested and the fusion protein was purified via affinity binding on GST beads (Sigma, G4510).

***In vitro kinase assay.*** Bacterial expressed purified GST (2 $\mu$ g), GST-Fra-2 (2 $\mu$ g), or MBP (NEB, P6021S) (2 $\mu$ g) were incubated with radioactive  $\gamma^{32}$ P-ATP (Amersham) with or without purified ERK2 (20ng) kinase (NEB, P6080S). Samples were incubated at 30°C for 40 min before addition of 4x SDS sample buffer and boiled for 5 min. Samples were resolved on an 8 % SDS-PAGE gel which was Coomassie stained to visualize bands. The gel was dried and exposed to film to capture light emitted by  $\gamma^{32}$ P-ATP-labelled proteins.

***In-gel digestion and mass spectrometry analysis.*** The kinase assay as indicated above was repeated, replacing the radiolabelled  $\gamma^{32}$ P-ATP with unlabelled ATP (NEB, P0756S), and the band shift was observed once again in a Coomassie blue stained gel when GST-Fra-2 was incubated with ERK2, however, an 8% SDS-PAGE gel was run to achieve greater resolution of the bands. The lower mobility phosphorylated GST-Fra-2 band was excised along with the un-phosphorylated GST Fra-2 band. These bands were digested with trypsin overnight at 37°C. Tryptic peptides were loaded onto a HPLC Chip (160 nl high capacity sample enrichment column and 75- $\mu$ m x 150 mm

SB-C18 separation column, Agilent Technologies, Santa Clara, CA, USA) and separated by flow rate at 300 nL per minute, with solvent A (0.2(v/v)% formic acid in water) and solvent B (100 % acetonitrile) and the following gradients: at 0, 50, 54, 56 minute after injection with 3%, 35%, 80%, 100% solvent B, respectively. The LC-MS/MS analysis was carried out using an Agilent 1100 HPLC-chip and 6340 ion trap system with MS scan range from 300 to 1,300 m/z and back-to-back CID/ETD (collision-induced-dissociation/electron transfer dissociation). 30 seconds dynamic exclusion was applied to the precursor previously selected for MS/MS twice. Raw data files from LC-MS/MS were searched against a custom protein sequence representing GST-Fra-2 using Spectrum Mill MS Proteomics Workbench (v03.03.084, Agilent Technologies). The Data Extractor utility program detected peaks, assigned precursor charges where possible (for those not successfully determined, 2+ to 5+ were considered), filtered MS/MS spectra by quality (spectra with peak number > 4 and sequence tag length > 2 were kept for MS/MS search), centroided the MS/MS spectra, merged nearby MS/MS spectra from the same precursor by default MS/MS similarity criteria and generated peak lists. Peak lists were searched by the following criteria: two missed trypsin cleavages, fixed modification (carbamidomethylation on cysteine), variable modifications (oxidized methionine, pyro-glutamic acid modification at N-terminal glutamines, phosphorylated-serine, -threonine, and -tyrosine), precursor mass tolerance +/- 2.5 Da, product mass tolerance +/- 0.7 Da. The spectra identified by Spectrum Mill to be phosphorylated were manually verified and reported.

***Immunocytochemistry.*** Cells were grown to the desired state and media was removed. Cells were washed with 1X PBS and fixed with 70% methanol. Cells were blocked in 5% milk in 1X PBS and incubated with MyHC primary antibody. Primary antibody was removed and cells were washed with 1X PBS and incubated with anti-mouse secondary antibody HRP-conjugated. A final concentration of 10mg/ml of DAB (Sigma, D8001) and 3% hydrogen peroxide (Sigma, 216763) were used as a substrate and the nuclei were stained with haematoxylin (Sigma, H3136).

***Limited proteolytic cleavage.*** *In vitro* kinase was performed as described above and the reaction products incubated with trypsin (Roche) at 16°C for the indicated times. At each time point 4X SDS loading buffer was added to stop cleavage. Samples were boiled and analyzed by Western blotting.

***Primary skeletal muscle fibre isolation and immunofluorescence analysis.*** Myofibres were isolated from the muscle of 4- extensor digitorum longus (EDL) month-old female C57Bl/6 mice as described in detail by Otto et al (2008). Briefly, undamaged EDL muscles were dissected with both tendons intact and the single fibres liberated through digestion with 0.1% type I Collagenase in DMEM at 37°C 5% CO<sub>2</sub>. Heat flame tapered glass pipettes were used to plate isolated single fibres into floating culture wells containing DMEM supplemented with 10% horse serum and 0.5% chick embryo extract for up to 72h. For immunocytochemistry, myofibres were fixed in 2% Paraformaldehyde in PBS for 10 minutes and washed 3 times in PBS. Myofibres were permeabilised in a solution of 20 mM HEPES, 300 mM sucrose, 50 mM NaCl, 3 mM

MgCl<sub>2</sub> and 0.5% Triton-X100 (pH7) at 4°C for 15 minutes and incubated in blocking wash buffer (5% newborn calf serum in PBS containing 0.01% triton X-100) for 30 minutes prior to antibody incubation. Antibodies were diluted and pre-blocked in wash buffer for 30 minutes prior to addition to the myofibres. Primary antibodies used were: Monoclonal mouse anti-Pax7 and anti-Myogenin (clone F5D) both from (DSHB) 1:1, Fra-2 (SantaCruz Q-20) 1:2000 and phospho Fra-1 (Cell Signalling Technology #3880) 1:1000. All primary antibodies were incubated with fibres overnight at 4°C. Primary antibodies were visualised using the following secondary antibodies: Alexa Fluor goat anti-mouse 594 (A11032 Molecular probes), Alexa Fluor goat anti-rabbit 488 (A11034 Molecular probes). Secondary antibodies were used at 1:200 and incubated at room temperature for 45 minutes. All myofibres were mounted in Fluorescent mounting medium (DAKO cytomation) containing 7.5mg/ml DAPI for nuclear visualisation. Mounted myofibres were analysed using a Zeiss Axioscope fluorescence microscope and images captured using an AxioCam digital camera system and Axiovision image analysis software (version 4.7).

## **Results**

### **Fra-2 is a downstream target of cytokine activated cellular signalling pathways that inhibit myogenic differentiation**

Expression of the AP-1 transcription factors has been observed in differentiating myogenic (C2C12) cells even though exogenous expression of c-Jun has been shown to repress myogenesis (Thinakaran et al., 1993). We previously determined that Fra-2 is the main Fos related subunit of the AP-1 DNA binding complex in myogenic cells and its regulation may be mediated by phosphorylation (Andreucci et al., 2002). Fra-2 is known to be a ERK 1/2 MAPK target (Eriksson and Leppa, 2002; Murakami et al., 1997) and the ERK 1/2 MAPK pathway is active in proliferating MB cells and in later stages of differentiation where it is critical for MB fusion (Li and Johnson, 2006). Growth factors that suppress differentiation are involved with the maintenance of the undifferentiated state such as CT-1 (Miyake et al., 2009). These growth factors, specifically CT-1 have also been shown to activate ERK 1/2 and we therefore postulated that Fra-2 may be a downstream target in myogenic cells. When MB in serum reduced conditions were treated with CT-1 (10ng/ml) we observed an increase in P-ERK 1/2 10 to 30min post treatment (see supplementary figure S1). Concurrently we observed a low mobility Fra-2 band which was correlated with the activation of ERK 1/2 in CT-1 treated cells (see supplementary figure S1). Our data indicate that CT-1 was able to activate the MEK 1/2-ERK 1/2 MAPK pathway and target Fra-2 by inducing a slower migrating Fra-2 band in C2C12 cells (figure 1A). To test whether the lower mobility Fra-2 band was ERK 1/2 dependent we used an inhibitor of activated MEK 1/2 (PD 98059) to block ERK 1/2 activation. Figure 1B indicates that

the slower mobility Fra-2 band seen with CT-1 (10ng/ml) treatment was reduced by the addition of the MEK 1/2 inhibitor PD 98059 and was correlated with reduced P-ERK 1/2 levels. Thus, repression of ERK 1/2 activation by pharmacological inhibition of MEK 1/2 resulted in a loss of the modified form of Fra-2 in C2C12 cells. These data implicate ERK 1/2 activation by CT-1 with changes in the mobility of Fra-2 and repression of myogenesis.

To directly test whether the change in Fra-2 mobility with CT-1 was due to direct phosphorylation we analyzed mobility changes of endogenous and exogenously expressed Fra-2 in the presence or absence of CT-1 in C2C12 MB cells (figure 1C). Fra-2 was immunoprecipitated from MB and treated with calf intestinal phosphatase (CIP) which resulted in the loss of the slower mobility Fra-2 band (figure 1D). Interestingly, in addition to loss of the higher mobility Fra-2 band we observed enhanced mobility of all the immunoreactive Fra-2 after CIP treatment suggesting that Fra-2 exists in various states of phosphorylation (figure 1D).

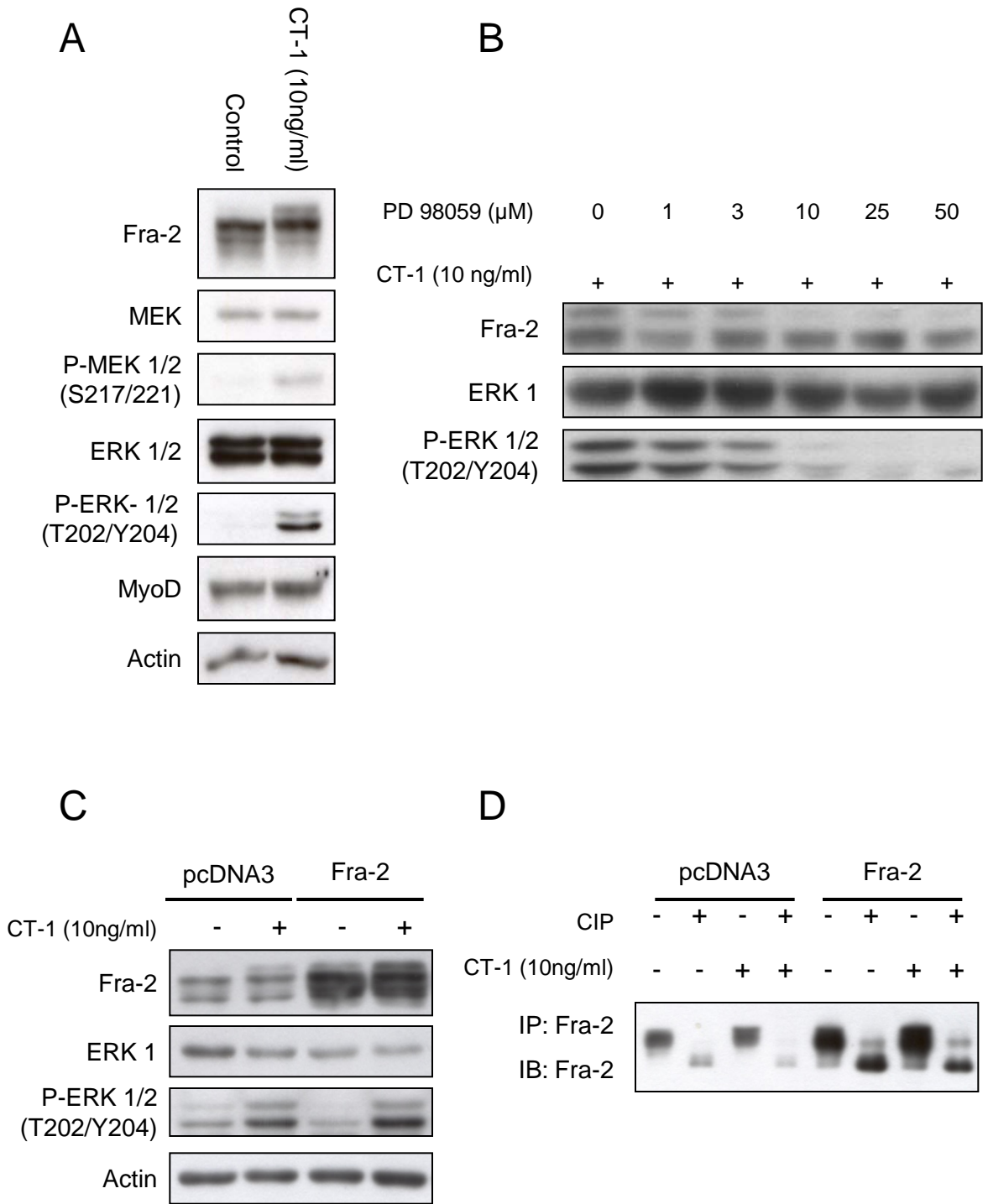

Figure 1



**Figure 1. Fra-2 is a downstream target of the MEK 1/2 -ERK 1/2 MAPK pathway.** (A) C2C12 MB were serum starved for 8 h prior to treatment with Cardiotrophin-1 (10ng/ml) or solvent control. Cells were harvested after 20min of CT-1 treatment and Fra-2 expression was assessed by Western blotting. (B) Proliferating MB following serum withdrawal for 8 h were pre-treated with PD98059 1 h prior to CT-1 (10ng/ml) treatment. Cells were harvested 20 min after CT-1 treatment and analyzed for Fra-2 expression by Western blotting. (C) Western blot of exogenously expressed Fra-2 in cells treated with CT-1 (10ng/ml). C2C12 MB expressing exogenous Fra-2 were incubated with CT-1 (10ng/ml) for 20min prior to harvesting. Total cell lysates were prepared and Fra-2 was IP from cells. (D) The Immunoprecipitated samples were treated with calf intestinal phosphatase (CIP) or its buffer before Western blotting.

## **Identification and characterization of ERK 1/2 specific Fra-2 phosphorylation sites**

Since there is always some ambiguity as to the true identity of kinase-substrate interactions in cell lysates, we performed an *in vitro* kinase assay to assess if Fra-2 was directly phosphorylated by activated ERK 1/2. Figure 2A (first panel) shows that when GST-Fra-2 was incubated with activated ERK 2 and  $\gamma$ -<sup>32</sup>P-ATP a change in mobility of the GST-Fra-2 protein was seen in the Coomassie blue stained gel (as marked by asterisks in the first panel) in agreement with the cell based studies. In addition, the slower mobility complex was hyperphosphorylated as indicated by  $\gamma$ -<sup>32</sup>P-ATP radioactive incorporation into the Fra-2 protein when the gel was exposed by autoradiography (figure 2A second panel), thus, directly showing that Fra-2 was phosphorylated by ERK 2.

To begin to define the effects of ERK 1/2 on Fra-2 we mapped the specific phosphorylation sites on Fra-2 by ERK2 using mass spectrometric methods. We performed an *in vitro* kinase assay using GST-Fra-2 as substrate and ERK2 as kinase and processed the Coomassie blue stained Fra-2 protein bands for mass spectrometric analysis. Using this methodology, four phosphorylated peptides were detected (boxed in figure 2B) containing four proline directed phosphorylated residues: S120, S200, S230, S320 and one potential non-proline directed site T322 (bold in figure 2B) were identified. These phosphopeptides were selected and fragmented by tandem MS. Figure 2C (first panel) shows an ETD MS/MS spectrum of a precursor peptide (m/z 1023.5 doubly charged) which corresponds to amino acids 317-326 of Fra-2 with an extra 80 Da. Note that in the ETD spectrum, fragments from the N terminus give C ion

series and fragments from the C terminus give Z ion series and the peptide bond N-terminal to a proline residue does not break. The observed C ion series (C10, C12, C13, C15, C17, C18, and C19) supported the identity of the peptide (317-SSSSGDQSSDSLNSPTLLAL-326). In addition, though fragment C14 was not expected due to the nature of a proline residue in the ETD spectrum, the difference between the C13 (1269.7 m/z) and C15 (1534.8 m/z) fragment ions is 265.1 Da which is equal to a combination of theoretical mass of serine and proline and an extra 80 Da. Thus, it is clear that S320 was phosphorylated in this ETD spectrum. Similarly in figure 2C (second panel) the C13 ion had a m/z of 1269.6 Da and C16 of 1634.7 Da. The difference between the two ion fragments is 365.1 Da which is the mass of serine, threonine and proline. The theoretical mass of serine, threonine and proline is 285.31 Da and since the difference between the observed (365.1 Da) and the actual (285.31 Da) fragment mass was 80 Da we can conclude that the serine or threonine is phosphorylated. Thus, these data support phosphorylation at S320 and T322 on Fra-2.

A

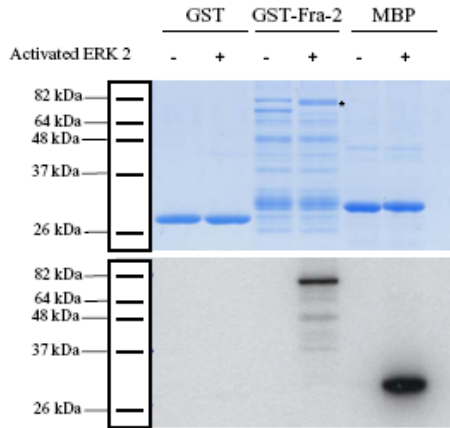

B

	10	20	30	40	50	60
MYQDYPGFD	TSSRGS	SGSF	AHAESYSSGG	GGQKFRVDM	FGSGSAFIT	INAITTSQDL
	70	80	90	100	110	120
QWMVQPTVIT	SMSNFPYRSH	PYSFPLGLAS	VFGHMALPRP	GVIRTIIGTV	GSRRRDEQLS	
	130	140	150	160	170	180
FEFEERIR	RERNKLAALK	CRNRRRELTE	KLQAETELE	EKSGLQKEI	AELQKEKEL	
	190	200	210	220	230	240
EFMKVANGFV	CRISPEEES	PFTSGLQSLR	GTGSAVGPVV	VNPEFEEDS	PSSSAGMDIT	
	250	260	270	280	290	300
QRSVIRKPSI	AGGGFYGEFP	LHTPIVVIST	PAITPGTSLN	VFTYENVLQ	ESFSSSEESC	
	310	320				
SKAHRSSSS	GDQSSDSLNS	PTLLAL				

C

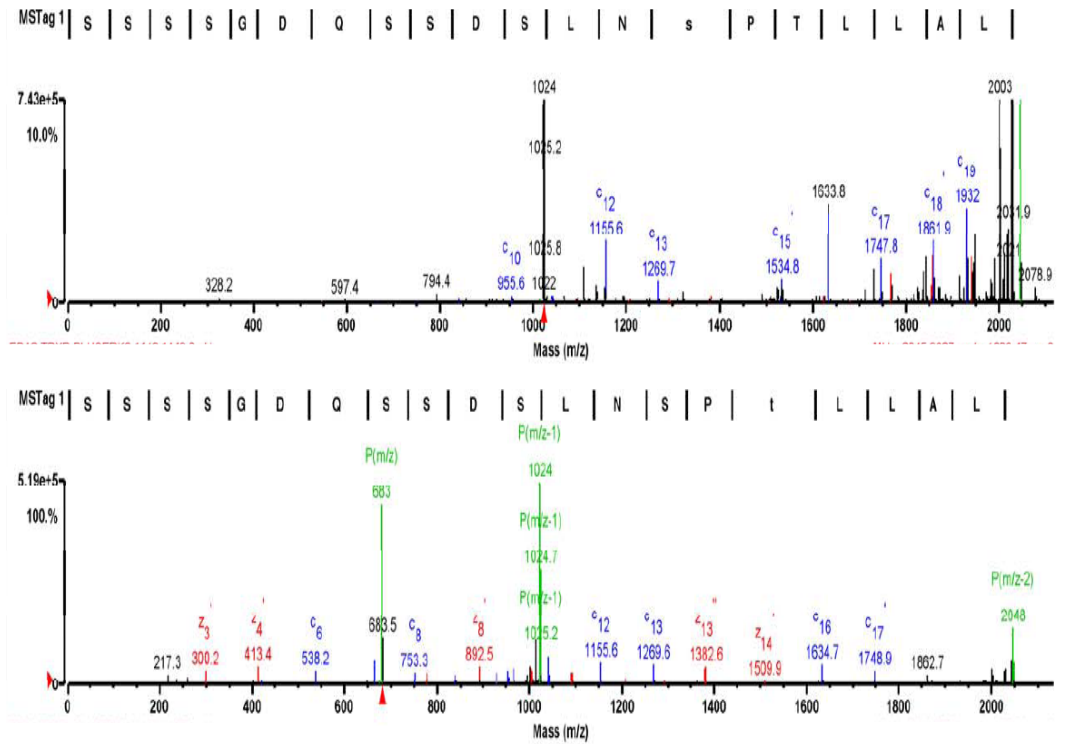

Figure 2

**Figure 2. Identification of Fra-2 phospho-acceptor sites using phospho-peptide mass spectrometry analysis.** (A) Purified GST, GST-Fra-2, or MBP were incubated with  $\gamma$ - $^{32}$ P-ATP and activated ERK 2 or its buffer *in vitro*. The samples were run on an 8% SDS-PAGE gel which was Coomassie stained (panel A), dried and exposed to film (panel B). GST alone was used as a negative control and MBP was used as a positive control. (B) Linear Fra-2 amino acid sequence. The *In vitro* kinase assay was repeated with GST-Fra-2, activated ERK 2 and unlabeled ATP. Samples were resolved on an 8% SDS-PAGE gel and the unphosphorylated and phosphorylated GST-Fra-2 bands were excised, digested by trypsin and the resultant peptides were analyzed by mass spectrometry. The results from the mass spectrometry analysis are summarized: where phospho-peptides detected by mass spectrometry are boxed, DEF domain (282-285) is underlined and ERK 2 phosphorylated residues (120, 200, 230, 320, 322) are in bold. (C) Spectra for S320 (first panel). C13 ion has a m/z of 1269.7 and C15 ion 1534.8 and a difference of 265.1. The C13 ion is composed of S and P which have masses of 87.08 and 97.12 respectively, added together to give 184.2. The difference between 265.1 and 184.2 is 80.90 which corresponds to a addition of a phosphate group. The spectra for T322 (second panel) has a C13 of 1269.6 and C16 1634.7 has a difference of 365.1. The C16 ion corresponds to S, P, T, which m/z of 87.08, 97.12, and 101.11 respectively added together gives 285.31. The difference gives 79.79 corresponding to an addition of a phosphate group.

## **Mutational analysis of Fra-2 specific phosphorylation sites**

We next sought to determine the function of the Fra-2 phosphorylation sites identified by mass spectrometry. To address this, a series of combinatorial Fra-2 phospho acceptor site mutations were generated by site-directed mutagenesis. Some interesting observations were made when the combinatorial mutations were expressed in C2C12 cells. Fra-2 phospho-mutations containing S320A and/or the T322A mutation altered the Fra-2 protein mobility pattern compared to wild-type Fra-2 which was similar to Fra-2 DEF which contains a mutation in the ERK 1/2 docking site. Fra-2 containing S320A and/or T322A had an observable loss of the slower migrating hyperphosphorylated Fra-2 band while mutations not containing S320A or T322A did not (see supplementary figure S2). Interestingly, expression levels of Fra-2 containing S320A and/or T322A mutations were expressed at lower levels in addition to the loss of the slower mobility (High Mr) band (figure 3A). Initial mutational data suggested that S320 and T322 might be important phosphorylation sites for Fra-2 stability. Interestingly, S320 is a conserved phosphorylation site on Fra-1 and a similar observation was previously reported (Basbous et al., 2008), however, the T322 site has not been examined in any Fos family member. In order to assess the function of these sites, single neutralizing mutation of S320 and T322 to alanine were generated and expressed in C2C12 cells. Neutralization of S320 or T322 alone resulted in loss of the slower mobility band and reduced notably expression of Fra-2 (figure 3B). The double mutation: both S320A and T322A had similar effects to the single mutations. These results suggest that S320 and T322 are responsible for hyperphosphorylation of Fra-2; moreover lack of phosphorylation at these sites contributes to a marked decrease in Fra-

2 protein levels compared to wild-type Fra-2. Interestingly, we noticed that neutralization of S320 and T322 to alanine causes Fra-2 to become considerably less stable than wild-type Fra-2 (figure 3B) and we therefore postulated that phospho-mimetic mutation would result in the opposite effect. Expression of S320D and T322D mutants reconstituted Fra-2 stability similar to wild-type Fra-2 (figure 3B) suggesting that phosphorylation at S320 and T322 is required for Fra-2 protein stability. To confirm phosphorylation of Fra-2 on S320 we used a phospho-Fra-1 antibody that reacts with the conserved peptide containing phospho-S320 of Fra-2. Wild-type Fra-2 when phosphorylated at S320 could be detected at high levels using the phospho-specific antibody indicating its efficacy (figure 3B). As expected Fra-2 S320D was undetectable with the phospho-specific antibody but unexpectedly cells expressing Fra-2 T322D did not have a high level of phosphorylated S320 (figure 3B). Moreover, we observed a reduction in phospho-S320 in Fra-2 when only T322 was mutated suggesting that T322 may be required for efficient phosphorylation of S320.

### **Fra-2 phosphorylation at S320 and T322 regulates protein stability**

Since our earlier experiments suggested that Fra-2 phosphorylation might alter its function in myogenic cells, the Fra-2 phospho-mutations were tested in MBs. We expressed the phospho-mutations S320A and T322A in MB and MT and observed reduced expression of the mutated versions compared to wild-type Fra-2 in MB and 72 h MT (see supplementary figure S3) suggesting that S320 and/or T322 are important sites for stabilizing Fra-2 throughout differentiation. Loss of phosphorylation at S320 and T322 destabilized Fra-2, possibly targeting it to the proteasome for degradation.

To address this further we treated C2C12 expressing the mutated Fra2 variants with the proteasome inhibitor MG132. When MG132 was included we noticed that the expression of the phospho-neutralizing mutations increased as well as wild-type Fra-2 and Fra-2 DEF (figure 3C). Thus, Fra-2 targeted proteosomal degradation is resisted by S320 and T322 phosphorylation. Our data suggest that CT-1 can activate the ERK 1/2 MAPK pathway which phosphorylates Fra-2 at S320 and T322 affecting protein stability.

Phosphorylation can result in conformational changes in protein structure with, in many cases, subsequent effects on function. Fra-2 protein is stabilized when phosphorylated by ERK 1/2 and we postulated that its conformation in the phosphorylated and unphosphorylated states may differ. When unphosphorylated at S320 and T322, Fra-2 is unstable. To determine if the phosphorylated form of Fra-2 is in a different conformation to the unphosphorylated protein we performed a limited proteolytic digestion assay. The idea of this assay is that if a protein is in an altered conformational state then its susceptibility to limited proteolytic digestion may be altered. After incubating GST-Fra-2 with activated ERK 2 kinase we observe a phosphorylated high mobility Fra-2 band (figure 3D). When digested for short time periods with trypsin we observe different patterns of peptide accumulation for the unphosphorylated and phosphorylated forms of GST-Fra-2 indicative of a change in conformation (figure 3D). This analysis provides initial structural evidence that ERK 1/2 phosphorylated Fra-2 is in an altered conformation compared to the unphosphorylated Fra-2. Further NMR and crystallography based studies will be required to fully characterize the ERK 1/2 dependent conformational changes in Fra-2.



Stability of Fra-2 is potently enhanced by phosphorylation at S320 and T322 and the next question concerns how this affects its function. Therefore, we investigated whether stability affected Fra-2 function during myogenesis. The Myogenin promoter is active in differentiation conditions and its activity is regulated by MyoD. Using Myogenin as a marker for skeletal muscle differentiation we found that wild type Fra-2 inhibited the induction of the Myogenin promoter and Fra-2 S320D and T322D mutations further blocked this activity (figure 3E) compared to the control. Thus, suggesting that stability of Fra-2 by phosphorylation may impede myogenesis.

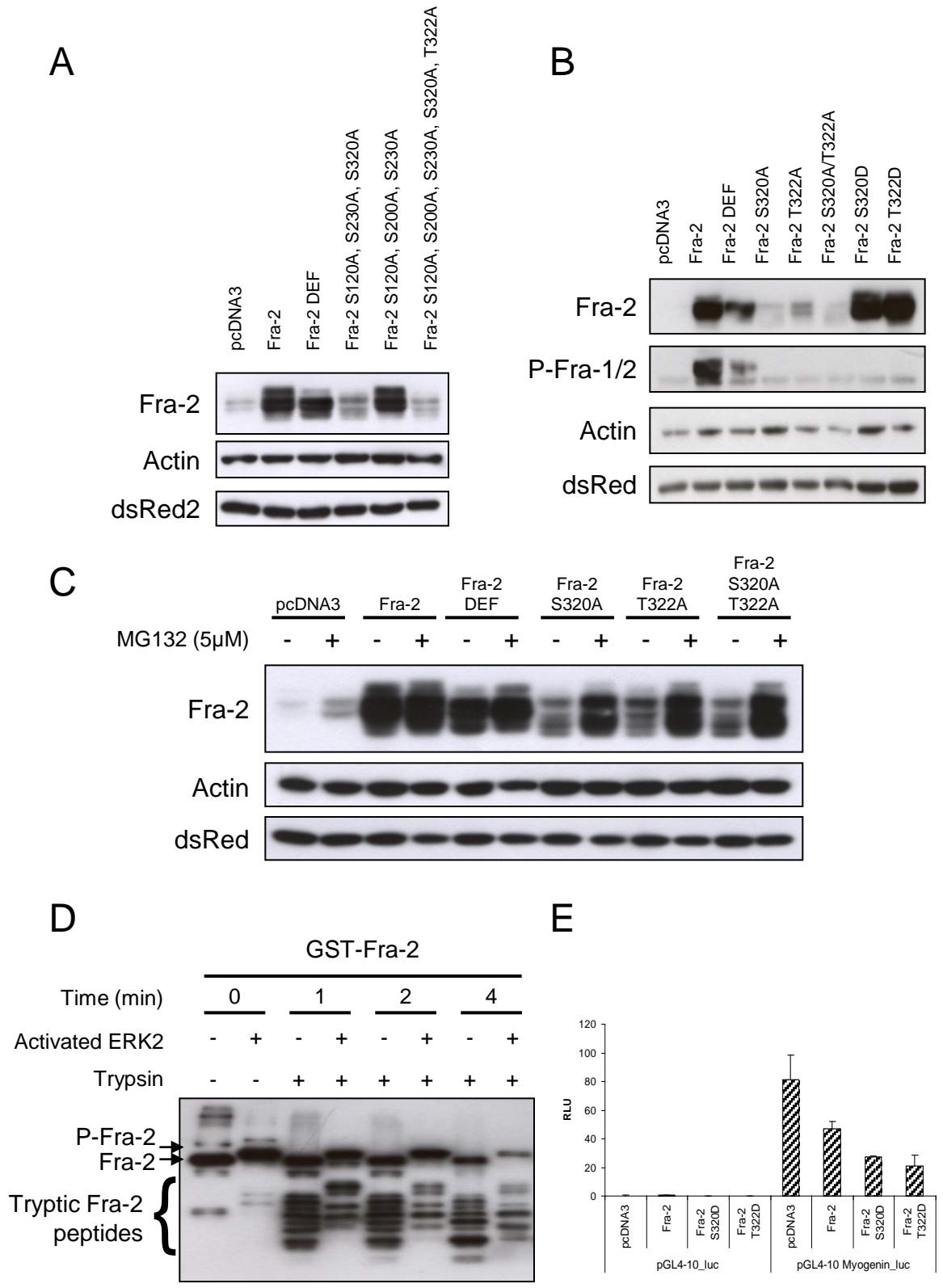

Figure 3

**Figure 3. Expression and stability of Fra-2 phospho-mutants in myogenic cells.** (A) Western blot analysis showing the expression of Fra-2 (wild-type), Fra-2 DEF and mutated proteins: Fra-2 S120A, S230A, S320A, Fra-2 S120A, S200A, S230A, Fra-2 S120A, S200A, S230A, S320A, T322A. (B) Western blot analysis showing expression of Fra-2 (wild-type), Fra-2 DEF, Fra-2 S320A, Fra-2 T322A, Fra-2 S320A/T322A, Fra-2 S320D and Fra-2 T322D in myogenic cells. (C) C2C12 cells treated with MG132 (5 $\mu$ M) for 5 h. Cells were harvested and expression of wild-type and mutated Fra-2 were analyzed by Western blotting. Actin was used as a loading control and dsRed as a marking of transfection efficiency. (D) Limited proteolytic digestion of GST-Fra-2. An *in vitro* kinase assay using 10 $\mu$ g of GST-Fra-2 and 2ng of activated ERK 2 was performed. The reaction was divided into seven tubes and trypsin was added at a ratio of 100:1 and incubated for the indicated times. Samples were run on a 10% SDS page gel and Fra-2 was detected by Western blotting. (E) C2C12 cells were transfected with wild-type Fra-2 or Fra-2 S320D or T322D and a myogenin promoter reporter gene (pGL4-10-*myogenin*-luc). Cells were maintained in DM conditions for 24 h prior to harvesting. Luciferase values were normalized to Renilla. Luciferase and Renilla values represent an average of three independent samples.

### **Loss of Fra-2 expression enhances myogenesis**

In an initial attempt to assess the functional role for Fra-2 in skeletal myogenesis, we silenced its expression using siRNA technology. Initially, three siRNAs targeting Fra-2 were characterized for their efficacy. All three siRNAs reduced Fra-2 protein level when compared to cells transfected with a negative control siRNA and untransfected cells, however siRNA2 gave the most optimal reduction (figure 4A). Fra-2 suppression in differentiating MB cultures resulted in no change in Fra-1 or c-Jun expression (figure 4B) during a time course of skeletal muscle differentiation. In conditions where Fra-2 was reduced, we observed an increase in late differentiation marker proteins MCK and MyHC compared to control conditions (figure 4B). Thus, a reduction of Fra-2 protein levels resulted in an observable increase in the expression of muscle specific differentiation markers.

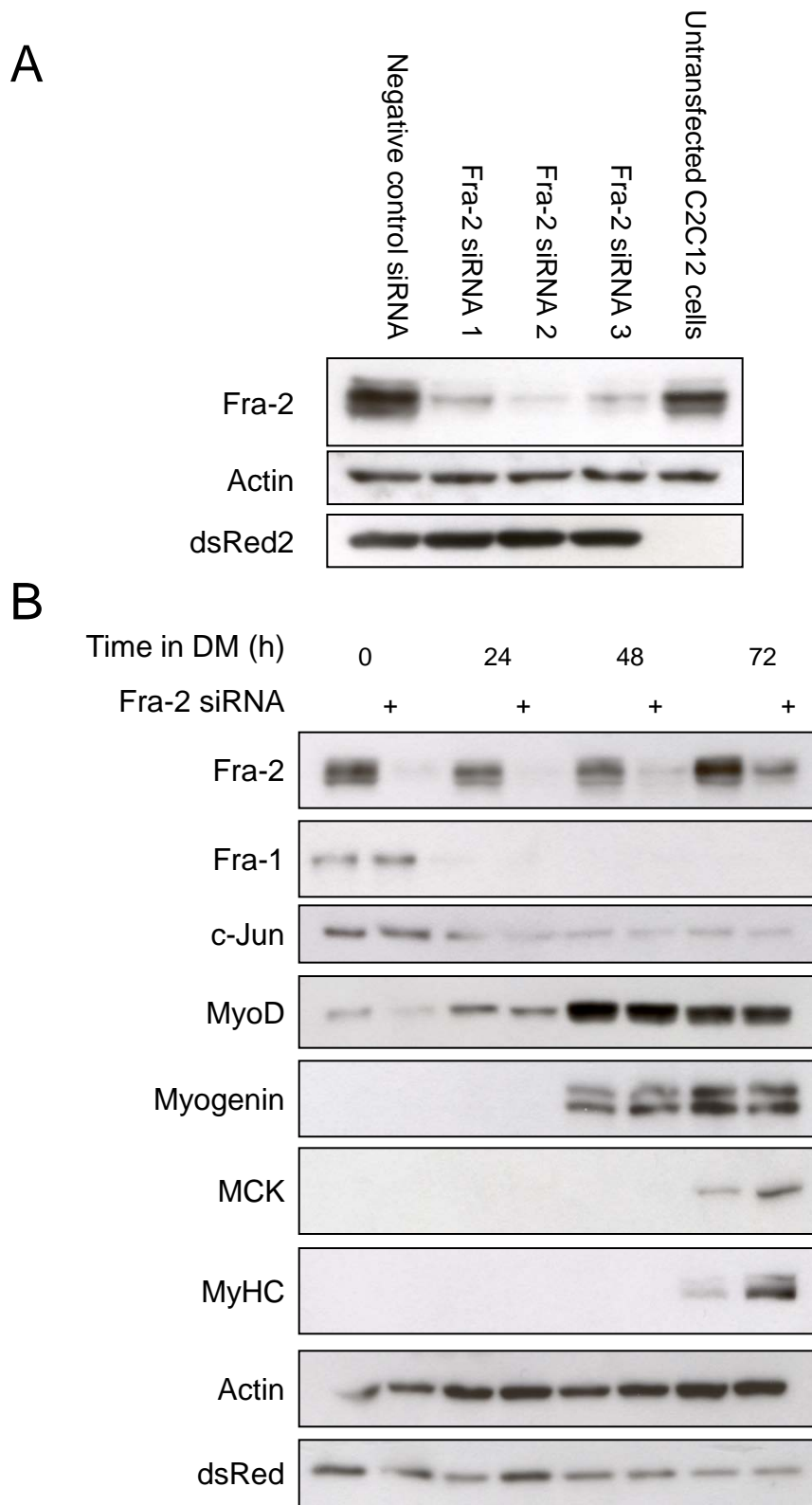

Figure 4

**Figure 4. Knock down of Fra-2 enhances differentiation.** (A) Three independent siRNAs targeting Fra-2 were transfected in proliferating C2C12 cells. Western blot analysis was performed to determine level of Fra-2 knock down. Actin was used as a loading control and dsRed as a marker for transfection efficiency. (B) Knock down of Fra-2 was assessed during a time course of C2C12 differentiation by Western blotting. Protein levels of some AP-1 components and myogenic markers were also analyzed.

## **Fra-2 expression in reserve and primary satellite cells**

In a differentiated culture of C2C12 cells as shown in figure 5A there is a bi-modal population of cells: multi-nucleated myotubes (indicated by an arrow) and mono nucleated “reserve cells” (as seen boxed). The establishment of the reserve population is a stochastic event since this is a clonal cell line in which all cells have the same potential when seeded, but yet some form MT while others remain quiescent and undifferentiated. Reserve cells and MT in a differentiated culture can be separated to assess differential gene expression (Cao et al., 2003; Stuelsatz et al., 2010; Sun et al., 2008). When separated the reserve cells and MT revealed differential expression of AP-1. Protein analysis in figure 5B shows that Fra-2 was expressed in proliferating MB in GM and in total differentiated lysate (includes MT and reserve cells). However, when MT and reserve cells were fractionated from a differentiated culture and western blotting performed we noticed that Fra-2 (along with c-Jun) was greatly reduced in MT while their expression was maintained in the reserve cells (figure 5B). Interestingly, Fra-1 expression was detected in only MB cells ruling out its involvement during differentiation. Since Fra-2 is not expressed in MT we attributed potentiation of differentiation to a reduction of the reserve cell population suggesting that Fra-2 ordinarily holds the cells in an undifferentiated state and, when its expression is extinguished, leads these cells to differentiate.

A

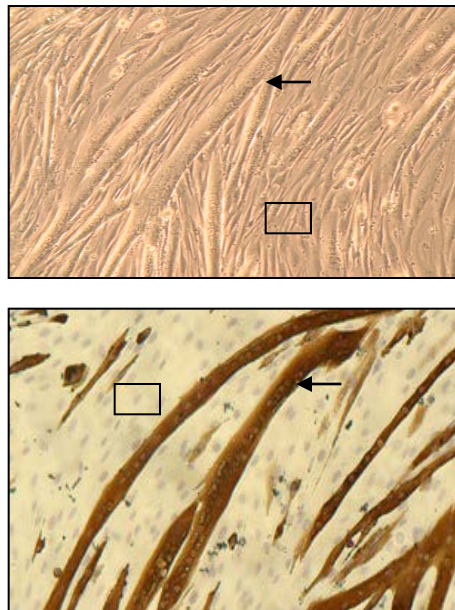

B

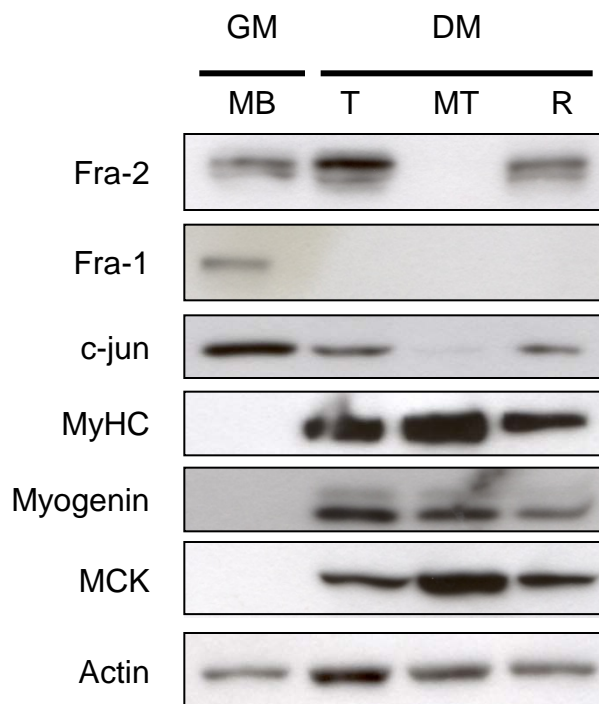

Figure 5



**Figure 5. Expression and localization of Fra-2 in myogenic cells.** (A) A 96h culture of differentiated C2C12 cells under phase contrast microscopy. The boxed cells are mononucleated reserved cells and the arrows indicate multinucleated myotubes. First panel depicts cells in culture maintained in DM and the second panel shows fixed cells immunostained for MyHC, a marker of differentiation, the nuclei were stained with haemotoxylin. (B) Western blot analysis was performed on proliferating C2C12 cells in GM conditions and differentiated cultures maintained in DM. The differentiated cultures were analyzed by total (T) which included all cells in a differentiated culture, myotube (MT), the fraction enriched for MT, and the reserve (R) fraction of mononucleated cells.

Reserve cells have been described as analogous to satellite cells, which lie within the basal lamina of muscle fibres and are activated after muscle injury. We performed immunostaining for Fra-2 and P-Fra-2 on primary muscle fibres at various time points and stained for Pax7 and Myogenin (figure 6A, B). In view of the analogy between reserve cells and satellite cells, we postulated that Fra-2 might play a role in satellite cells. To address this we used primary single fibre cultures in which myofibres are cultured with their associated satellite cells. In these cultures satellite cell activation and differentiation occurs in a manner similar to their activation *in vivo*. Fra-2 and its phosphorylated form were expressed at 48h in Pax7 positive cells and was not expressed in the myonuclei of the myofibre consistent with our idea that Fra-2, along with Pax7, marks satellite cells (figure 6A). At 72h myogenin expression was observed in cells that co-expressed Fra-2 (figure 6B). Interestingly, the Myogenin expressing cells did not co-express the phosphorylated form of Fra-2 (figure 6B). These data indicated that Fra-2 is expressed in both Pax7 and Myogenin positive satellite cells, while phospho-Fra-2 was only observed in cells expressing Pax7 but not Myogenin (figure 6C). Together, these data suggest that Fra-2 phosphorylation only marks activated satellite cells and the phosphorylation is extinguished in Myogenin positive differentiating cells.

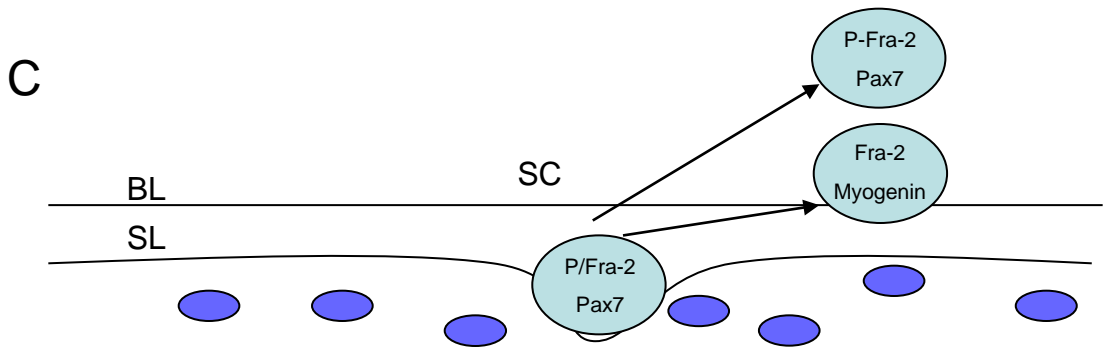
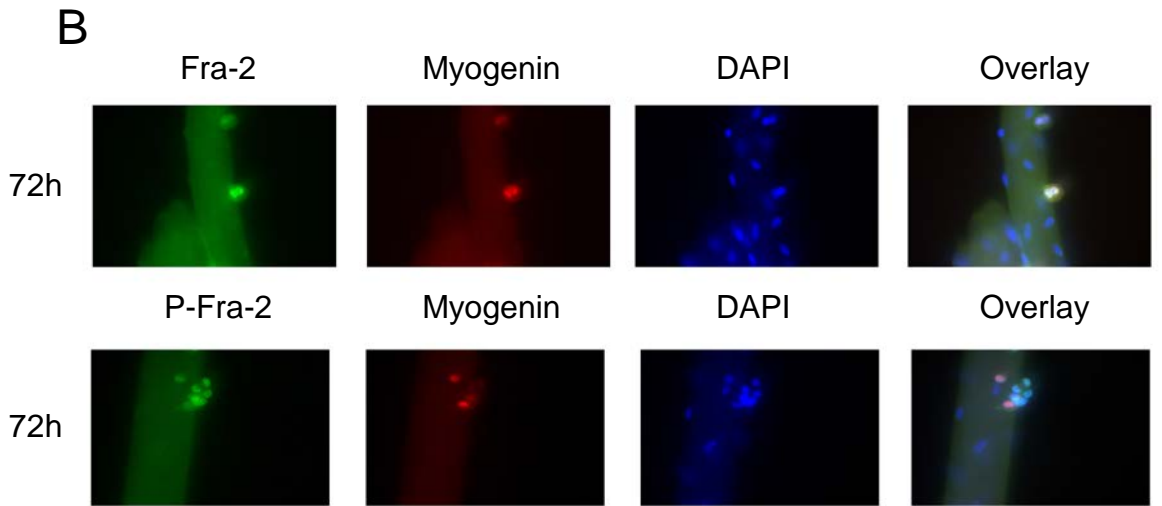
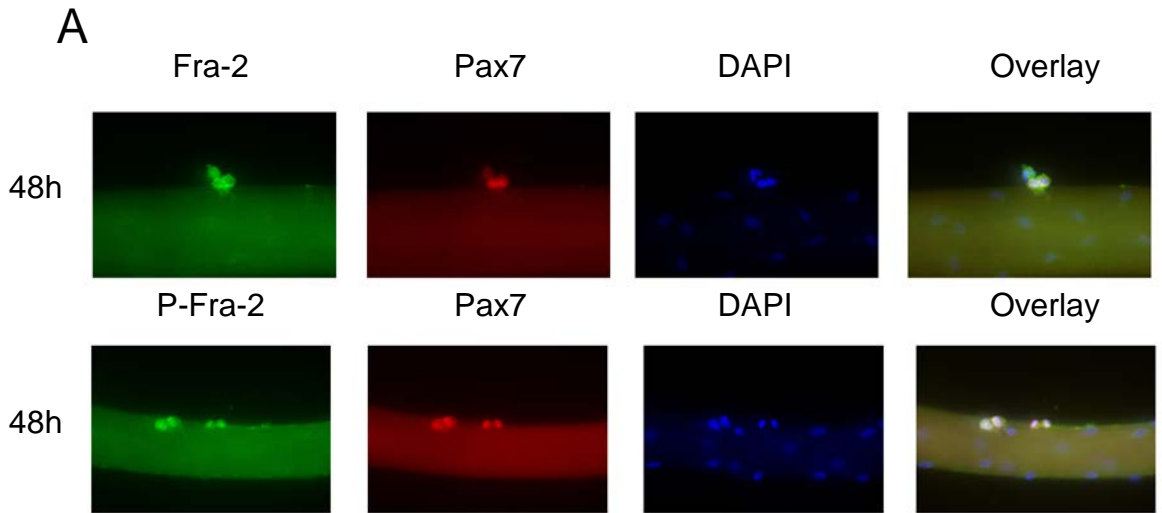

Figure 6

**Figure 6. Fra-2 expression in satellite cells.** Myofibers were dissected from EDL muscle of adult mice and cultured in a dish for the indicated times (48h and 72h) (A) Fibres were immunostained for Fra-2 (green) or P-Fra-2 (green), and Pax7 (red) at 48h in culture. Nuclei were stained with DAPI (blue). (B) Fibres were immunostained for Fra-2 (green) or P-Fra-2 (green), and Myogenin (red) at 72h in culture. Nuclei were stained with DAPI (blue). (C) Schematic representation of Fra-2, P-Fra-2, Pax7 and myogenin expression in satellite cells (SC) in single fibre cultures. Dark blue circles represent myonuclei, and light blue satellite cells that reside within the basal lamina (BL) and sarcolemma (SL).

## **ERK 1/2 inhibition modulates satellite cell differentiation and Fra-2 phosphorylation.**

In 48h primary single fibre cultures P-Fra-2 is expressed in Pax7 positive satellite cells but myogenin expression does not appear until 72h in culture and is not co-expressed with P-Fra-2. When 50 $\mu$ M of the MEK 1/2 inhibitor, PD 98059 was added to 48h primary culture fibres, P-Fra-2 levels decrease due to ERK 1/2 activation being inhibited (figure 7). In addition, Myogenin expression appeared precociously at 48h in fibres treated with PD 98059 compared to control treated fibres (figure 7). Taken together, these experiments are consistent with the idea that ERK phosphorylation and Fra-2 stabilization are congruous with the undifferentiated state in myoblasts and satellite cells. Conversely, repression of ERK signalling and concomitant hypophosphorylation and destabilization of Fra-2 result in enhanced myogenic differentiation (Figure 8). The identification of Fra-2 expression in both “reserve” and satellite cells may have important implications for a role in muscle maintenance and regeneration.

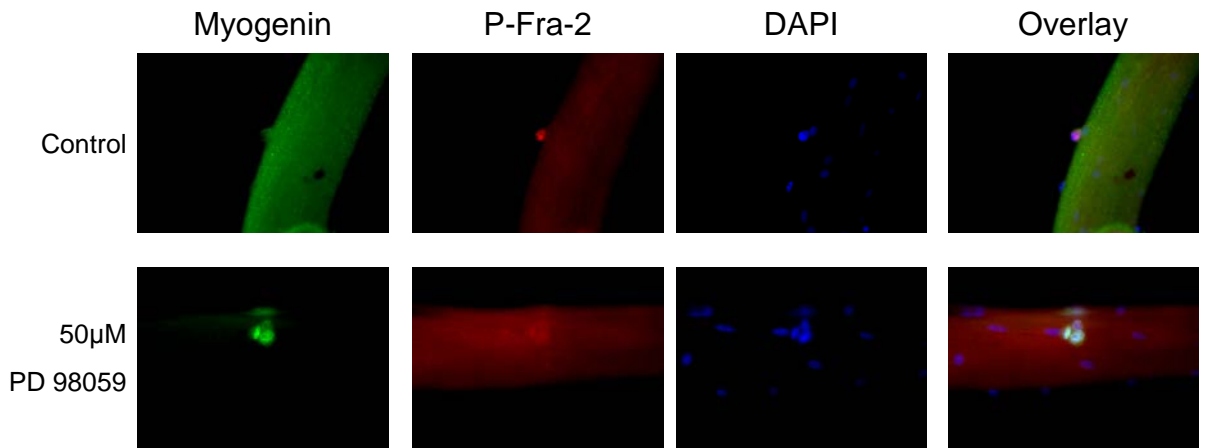

Figure 7

**Figure 7. MEK 1/2 inhibition activates satellite cell differentiation in primary muscle fibres.** Satellite cells in primary single muscle fibres from the EDL muscle were isolated from adult mice. After 48h in culture, fibres that were previously incubated with 50 $\mu$ M of the MEK 1/2 inhibitor PD 98059 or its control (DMSO) were immunostained for Myogenin (green) or P-Fra-2 (red). DAPI (blue) was used to mark nuclei.

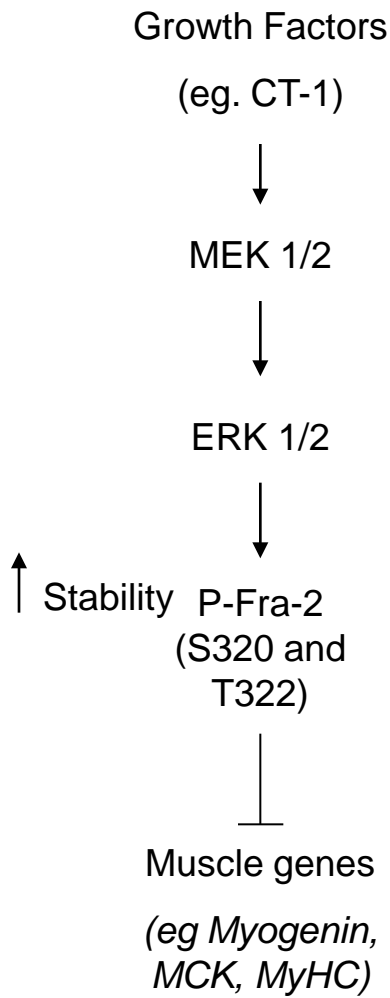

Figure 8



**Figure 8. Fra-2 phosphorylation may regulate muscle gene induction in C2C12 cells.** Fra-2 is phosphorylated at S320 and T322 by ERK 1/2 resulting in protein stabilization which leads to inhibition of muscle-specific gene expression and differentiation.

## **Discussion**

In this study, we report a novel regulation of the AP-1 subunit Fra-2 in skeletal myogenesis. We have demonstrated that Fra-2's expression is restricted to mono-nucleated "reserve cells" in a differentiated culture suggesting a possible role in maintaining the undifferentiated state. Additionally, we have identified an important level of regulation for AP-1 complex composition by identifying S320 and T322 as ERK 1/2 dependent phosphorylation sites on Fra-2 in skeletal muscle. These phospho-acceptor sites determine the contribution of Fra-2 to the AP-1 complex by potentially stabilizing Fra-2 protein levels. Neutralization of one or both of these sites destabilizes Fra-2 making it susceptible to proteosomal degradation. Conversely, phospho-mimetic mutation of S320 and T322 facilitate stabilization of the protein. Stabilization of Fra-2 contributes to the ensemble of gene expression leading to skeletal muscle differentiation.

### **Regulation and expression of Fra-2 in skeletal muscle differentiation.**

Fra-2 is expressed in cultured skeletal muscle cells and satellite cells indicating that it may be important for skeletal muscle gene expression. ERK 1/2 signalling has also previously been implicated as playing a complex bi-phasic role in skeletal muscle differentiation (Bennett and Tonks, 1997). Here, we show that Fra-2 is a primary ERK substrate in response to cytokine signalling in myogenic cells. We previously reported CT-1 as an inhibitor of differentiation and have implicated this cytokine as maintaining the undifferentiated state in myoblasts (Miyake et al., 2009). CT-1 is an activator of the ERK 1/2 pathway and we now report that it targets Fra-2 indicating the possibility that

AP-1 might be involved in maintenance of the undifferentiated state in myogenic cells. AP-1 expression is maintained in the “reserve population” in a differentiated C2C12 culture. These reserve cells are stochastically determined as cells that remain in a quiescent undifferentiated state despite the surrounding clonally equivalent cells forming differentiated myotubes (Kuang et al., 2007). In addition, our observations that Fra-2 is expressed in Pax7 positive satellite cells and not in the differentiated myonuclei supports a possible role in adult muscle progenitor cells. These preliminary data imply a previously unexplored role for AP-1 in regulating the reserve population (mononucleated cells in differentiation conditions) in an undifferentiated state and also satellite cells in mature muscle. Consistent with our data, AP-1 may be down regulated in MT as multinucleated cells become unresponsive to ERK 1/2 signalling. Also, it is possible that secreted factors from MT impede differentiation of adjacent myoblasts which establishes the reserve population by activating a paracrine signal pathway (Chan et al., 2007). If the cells become differentially responsive to ERK 1/2 signalling then Fra-2 would be unphosphorylated at S320 and T322 in differentiating myotubes when ERK signalling is down regulated which could be a mechanism to destabilize Fra-2 protein and promote its proteosomal degradation. Our observation that Fra-2 levels are reduced in differentiating cells and maintained in quiescent undifferentiated cells and satellite cells is consistent with this idea.

**S320 mediated Fra-2 protein stability is dependent on T322 phosphorylation.**

Interestingly, other Fos family members such as c-Fos and Fra-1 have a conserved serine at the site corresponding to S320 of Fra-2 in their C-terminus

(Acquaviva et al., 2001). Moreover the site corresponding to T322 of Fra-2 is also conserved on c-Fos and Fra-1 but has not been reported to influence the stability of these proteins. Here, we show that T322 of Fra-2 is vital for efficient phosphorylation and stabilization of Fra-2 primarily through its effect on S320 phosphorylation. Our data suggest that this site may function as a priming site for S320 phosphorylation however more detailed structural studies are required to further investigate the role of T322 (or its analogous residue in the other Fos proteins) in tandem with S320 for Fra-2 stabilization.

#### **AP-1 as a direct regulator of a variety of muscle specific genes.**

Recently Cao et al., reported that a large subset of genes regulated by MyoD in skeletal muscle cells are enriched with AP-1 sites (Cao et al., 2010). These data suggest that AP-1, similar to MyoD, may regulate a number of genes in the muscle lineage. Many of these genes prove to be down-regulated during myogenesis. These differential effects of AP-1 at different gene loci reflects a common theme of modern transcription factor biology in which the effect of a particular factor on a target gene is dependent on the combinatorial influence of co-factors and other transcription factors at any given promoter/enhancer, as well as the myriad post translational events that converge on each transcriptosome. There are still a number of important paradoxes to explain with regard to AP-1 and its role in a variety of cellular contexts and processes. Part of the answer may lie in the promiscuous nature of AP-1 in its ability to interact with a diverse network of factors that may lead to complex transcriptional outcomes that are dependent on higher order transcriptosome network dynamics.

### **Fra-2 as part of the AP-1 complex.**

The variation in AP-1 complex composition can dictate how it will function (Andreucci et al., 2002). Fra-2 is one component of a functional AP-1 complex which can also comprise of Jun-Jun, Jun-Fos or Jun-ATF2 dimers (Daury et al., 2001). In differentiating skeletal muscle, our data demonstrate that Fra-2 is the primary AP-1 subunit binding DNA which dimerizes with either c-Jun or JunD (Andreucci et al., 2002). This suggests that Fra-2 is the major regulator in AP-1 complexes formed in myogenic cells. Thus, establishing a role for Fra-2-c-Jun and Fra-2-JunD complexes could provide insight into differential gene regulation by AP-1 complexes. In other systems it has been determined that AP-1 function differs depending on its dimer composition (Abell et al., 2009). Differential subunit recruitment of co-factors is also a factor that might influence AP-1 specificity. For, example Trip6, a LIM domain protein, was found to interact with Fos family members but not Jun proteins (Diefenbacher et al., 2008) which illustrates an additional level of regulation for Fos proteins possibly including Fra-2.

### **Functional specificity and redundancy for AP-1 components.**

In an attempt to characterize the role of individual AP-1 subunits some groups have generated and analyzed AP-1 knockout mice. Deletion of *c-jun*, *junB*, or *fra-1* are found to be embryonic lethal, while mice lacking *jund*, *c-fos*, or *fra-2* have specific organ defects (Jochum et al., 2001). To date no skeletal muscle defects have been reported for any of the AP-1 subunits. Interestingly, the *fra-2* homozygous null mouse dies within one week of birth and is runted implicating a possible lack of postnatal

muscle growth based on the fact that skeletal muscle constitutes the heaviest contributor to body mass. Conditional knockouts have provided more information on the role of individual AP-1 proteins in specific tissue types. For example c-Jun, when deleted in hepatocytes, impairs liver regeneration. Interestingly, some studies have analyzed the possible redundancy of AP-1 protein function by “knock in” strategies. For example JunB was knocked into the c-Jun locus and was found to largely rescue the embryonic lethality of c-Jun homozygous deletion (Passegue et al., 2002). Also, Fra-1 was knocked into c-Fos deficient mice and found to rescue c-Fos knockout defects (Fleischmann et al., 2000). Contrary to the gene targeting data that suggests specific functions of different AP-1 components in different tissue or cell types, the “knock in” data suggest that, to some degree, the specificity of AP-1 subunits may be more closely related to their spatial and temporal pattern of expression than differences in the properties of the individual subunits. This is indeed a controversial idea in view of the many studies that have shown unique properties of distinct AP-1 components, necessitating further clarification.

In summary, we have observed restricted expression of Fra-2 in the reserve and satellite cell populations in skeletal muscle. SiRNA mediated reduction of Fra-2 increases the commitment of cells to the differentiation program suggesting a possible role for Fra-2 in satellite cells. Additionally, we have identified and characterized two phosphorylation sites on Fra-2 that are targeted by ERK 1/2 signalling that potentially regulate Fra-2 stability in skeletal muscle. Fra-2 expression is restricted to cells that are maintained in the undifferentiated state suggesting that the signal dependent

stabilization of Fra-2 and its contribution to the AP-1 complex may be an important contributor to satellite cell function in response to a variety of cytokines.

**Conflict of interest**

The authors declare no conflict of interest.

S1

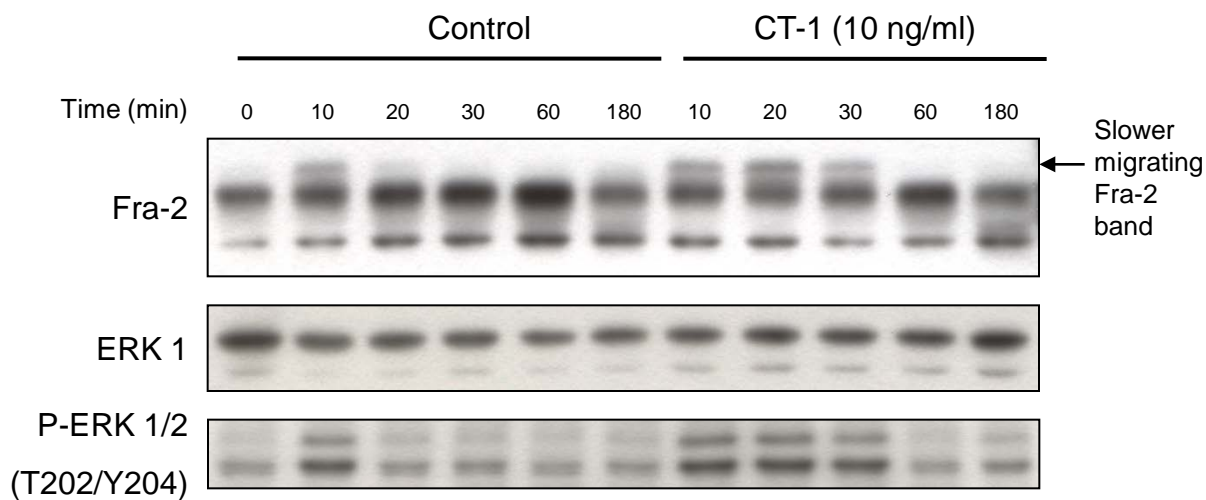

**S1. CT-1 transiently activates Fra-2 in C2C12 cells.**

C2C12 cells were serum starved for 8h followed by treatment with CT-1 (10ng/ml) and harvested at the indicated time points. Western blot analysis was performed to determine CT-1 effect on Fra-2 protein levels.



S2

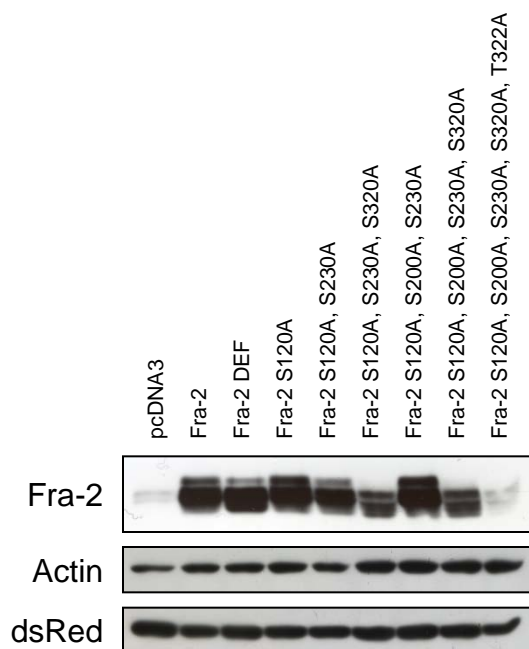

**S2. ERK 1/2 targets S320 and T322 are regulated sites on Fra-2.** Combinatorial mutation for Fra-2 phospho-sites were generated and transfected into C2C12 cells. Western blotting was used to determine expression of the mutated Fra-2 constructs. Actin was used as a loading control and dsRed as a marker for transfection efficiency.

### S3

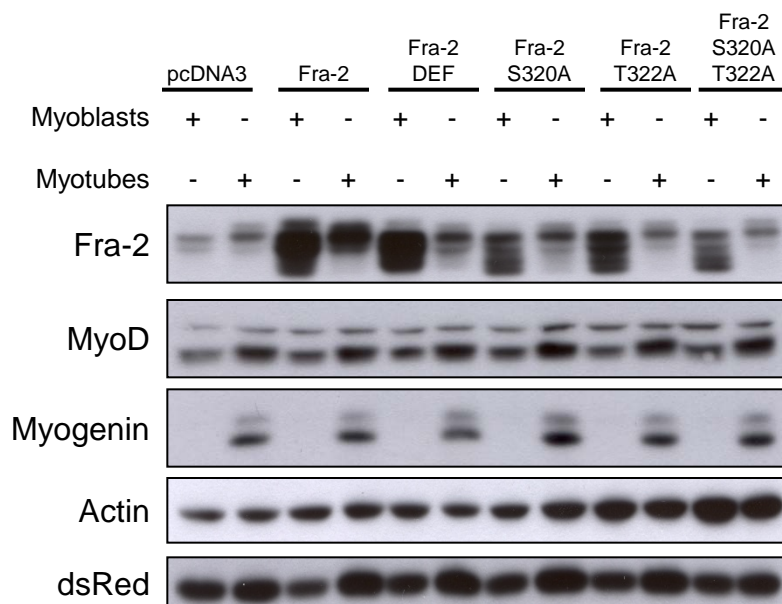

### S3. Neutralization of S320 and T322 on Fra-2 decreases protein expression.

C2C12 cells were transfected with wild-type Fra-2, Fra-2 DEF, or neutralization mutation for S320 and T322. Expression of Fra-2 and its mutation were assessed by Western blotting in MB and MT. Actin was used as loading control and dsRed as a marker for transfection efficiency.

## **Chapter V: Summary and conclusion**

## Chapter V: Summary and conclusion

The processes that encompass skeletal muscle development such as determination, proliferation and differentiation as well as maintenance and regeneration are regulated by MRFs and MEF2 family of transcription factors (Naya and Olson, 1999; Tapscott and Weintraub, 1991). While transcriptional control of these processes is established the upstream signaling events regulating MRFs and MEF2 are not well understood. The cytokine, CT-1, is a known cardiomyocyte hypertrophic factor that is also expressed in skeletal muscle. Activation of the MEK1/2/ERK1/2 and JAK/STAT pathways is initiated by CT-1 in skeletal muscle. However, MEK1/2, but not JAK/STAT, when activated by CT-1, was determined to be inhibitory to differentiation. Activation of MEK1/2 by CT-1 promoted interaction with MyoD repressing its transcriptional activity leading to inhibition of muscle gene expression (Miyake et al., 2009). Thus, a direct role for MEK1/2 in myogenesis was demonstrated in this work. Additionally, MEK1/2 is the upstream kinase of ERK1/2 which has a role in proliferation and maintenance of skeletal muscle. However, direct targets of ERK1/2 are not fully characterized in skeletal muscle.

Other transcription factors such as AP-1 augment gene expression in skeletal muscle contributing to the processes involved in myogenesis. AP-1 is known to activate proliferative genes in MB and also to inhibit differentiation. Studies reported here have expanded the putative role of AP-1 in myogenesis to maintenance and regeneration in adult muscle (Alli et al., 2013). Fos family members including Fra-2 are known to be regulated by phosphorylation by the ERK1/2 kinase which is also important in regulating skeletal muscle proliferation and quiescence. Previously, CT-1

was determined to maintain undifferentiated myogenic cells via MEK 1/2 signaling (Miyake et al., 2009). Using CT-1 it was observed that MEK1/2 activated ERK 1/2, a kinase that phosphorylates the AP-1 subunit, Fra-2. Consequently, it was determined that in skeletal muscle Fra-2 is phosphorylated on S320 by ERK1/2 resulting in a change in Fra2 protein stability. Stabilization of Fra-2 when phosphorylated on S320 negatively impacts differentiation possibly by maintenance of quiescence. A novel biological role for Fra-2 is proposed based on its restricted expression in reserve cells in a differentiated culture of C2C12 cells that includes myotubes. Moreover, differential expression of Fra-2 in satellite cells not in mature myocytes provides further evidence of a putative role in maintaining the undifferentiated state (Alli et al., 2013). Based on these studies, Fra-2 is now an established activated satellite cell marker that may also be required for progenitor cell maintenance.

In summary, inhibitory cytokines such as CT-1 repress skeletal muscle differentiation by MEK1/2 activation. Once activated MEK1/2 may directly repress expression of muscle specific genes by inhibiting MyoD activity or by activation of ERK1/2. Activation of ERK 1/2 leads to the phosphorylation of Fra-2 which maintains its stability repressing the differentiation program. AP-1 target genes are largely unidentified but *mustn1* is an AP-1 target gene in skeletal muscle and its mechanism of regulation and role has yet to be determined (figure 23).

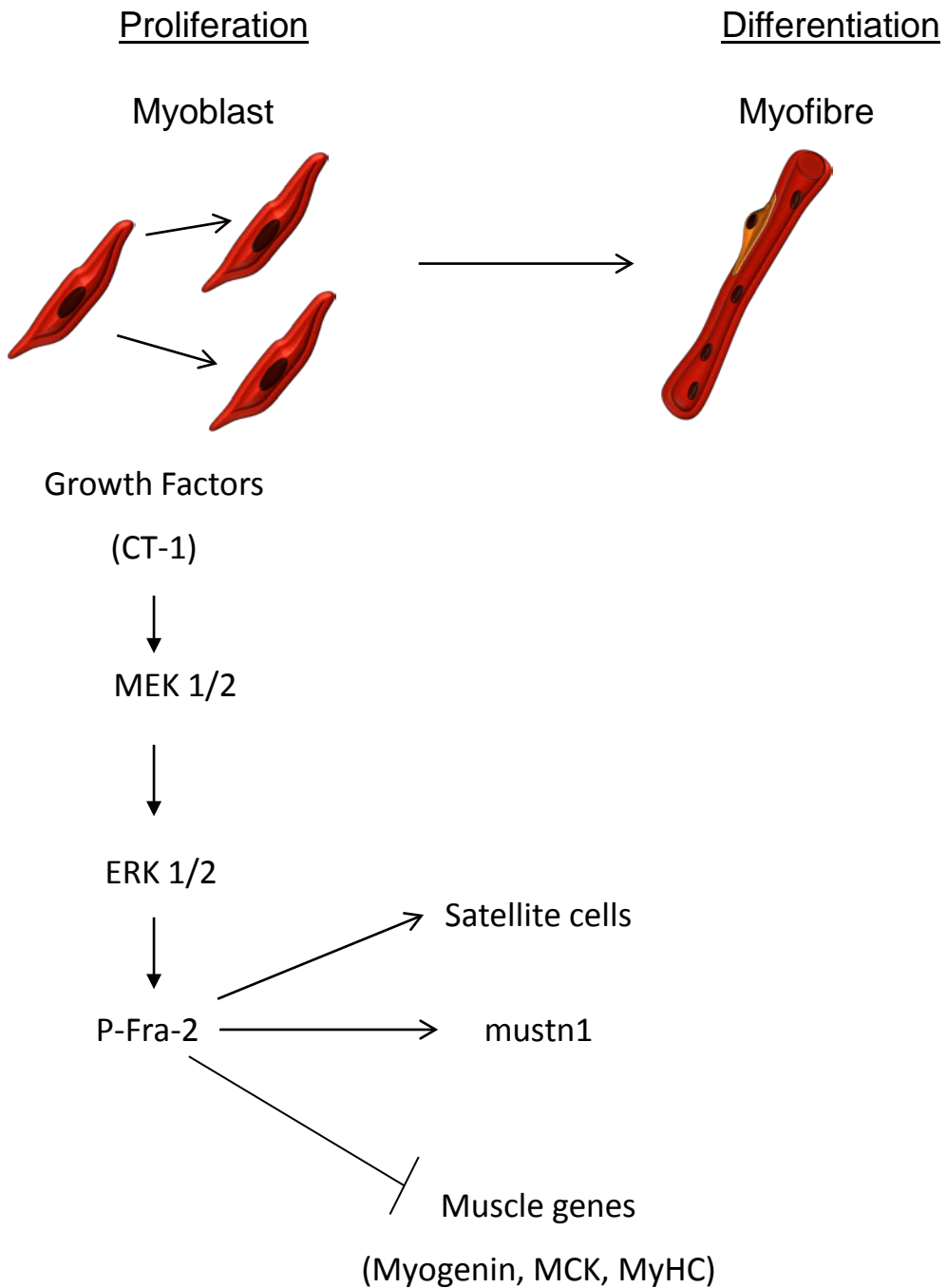

**Figure 25. Summary of AP-1's role and regulation in skeletal muscle development.**

In proliferating myoblast, Fra-2 is phosphorylated by ERK1/2 on S320, mediating protein stability. Stabilized Fra-2 leads to inhibition of muscle specific genes, while loss of Fra-2 expression upregulated muscle genes. In differentiated muscle, Fra-2 expression is reduced in myotubes and in myonuclei of muscle fibres. Fra-2 expression is elevated in mononucleated reserve cells and satellite cells of the muscle fibre.

Skeletal muscle specific target genes regulated by AP-1 are uncharacterized. Analysis of MyoD and MEF2 binding sites obtained from ChIP experiments may prove useful in identifying muscle specific AP-1 targets, as they are enriched for TREs (Cao et al., 2010). Exploring such target genes may provide further insight into a mechanism for AP-1 target gene regulation in skeletal muscle either enhancing or repressing muscle specific genes. An AP-1 ChIP sequencing study in C2C12 cells or satellite cells to determine target genes would provide a global profile of gene regulation in skeletal muscle. Although, AP-1 gene targets in skeletal muscle remain largely unknown, the *mustn1* gene may be a useful candidate for AP-1 regulation in myogenesis. The *mustn1* gene contains MyoD binding sites and is enriched for AP-1 sites (see Appendix A, figure 1). The expression profile for the *mustn1* gene shows that it is expressed in proliferating cells, and levels increase in differentiating C2C12 cells (see Appendix A, figures 2). In addition, Fra-2 was found to bind to the endogenous *mustn1* promoter in differentiating C2C12 cells (see Appendix A, figure 3). More recently, *mustn1* was found in satellite cells (Krause et al., 2013), which leads to the possibility that Fra-2 may regulate its expression in regeneration.

The regulation of Fra-2 and other AP-1 proteins is crucial to its function in skeletal muscle. The role of posttranslational modification is complex since Fra-2 is highly phosphorylated possibly by other unidentified kinases, as well as ERK1/2 described here. Whether, Fra-2 requires additional phosphorylation for dimerization or DNA binding has yet to be determined. It remains unclear what interacting partners mediate AP-1 activity. Therefore, knowledge of dimerization partners and co-factors that enhance or repress AP-1 protein activity would also be useful in understanding its

regulation. Studies focused on AP-1 gene regulation require identification of targets that mediate skeletal muscle development. Large scale studies such as AP-1 ChIP sequencing would identify genes bound by AP-1 which could be classified based on function. Such studies would provide insight into the different subset of genes regulated by AP-1.

Loss of function experiments in primary single fibres would be valuable to understand AP-1's role in satellite cells. Manipulation of AP-1 by siRNA in single muscle fibres followed by analysis of Pax7<sup>+</sup> cells would help determine the role of AP-1 in satellite cells. Gene targeting in mice provides a useful model for analyzing development effects in loss of function or gain of function studies. Fra-2 transgenic and conditional knockout mice would assist in investigating skeletal muscle phenotype and satellite cell regeneration in an *in vivo* model. Such experiments would test whether AP-1 is required for satellite cell activation and maintenance.

Examining the role of AP-1 in maintaining quiescence in other systems may be of interest. Rhabdomyosarcoma cells, which express muscle specific genes such as MyoD and Myogenin but do not differentiate into multi nucleated myotubes (Tonin et al., 1991), could be used as a model to investigate AP-1 regulation of undifferentiated cells. Somitic mesodermal cells that have the potential to commit to different cell lineages and it would be of interest if AP-1 was involved in keeping other cell types in an undifferentiated state. Treatment of C2C12 cells with some growth factors can redirect muscle to other phenotypes such as osteogenic or adipogenic (Fux et al., 2004). Since AP-1 is involved in maintaining quiescence these transcription factors may have roles in transdifferentiation processes allowing one cell type to change phenotype to



another. A novel role for AP-1 in pluripotency could be developed as well as potential use in stem cell therapies.

Molecular studies on skeletal muscle development involving AP-1 and CT-1 may be relevant clinically. Muscular dystrophies are characterized by loss of muscle mass or chronic muscle weakness. Cachexia and sarcopenia are also characterized by irreversible muscle loss. Given that these diseases are all characterized by muscle loss, studies directed at muscle regeneration are required. Since satellite cells are resident muscle stem cells, AP-1 could be a target for maintaining these cells. Stem cell and muscle precursor cells have been utilized in transplantations in attempts to restore muscle. However, satellite cell transplantations are not widely used due to the low yield after isolation. Regulation and activation of satellite cells in culture are currently being studied. Propagation of satellite cells in culture to generate higher yields could allow use for transplantation. Interestingly, it has been demonstrated that fibrosis reduces muscle regeneration. Using extracellular signaling molecules such as TGF- $\beta$  and myostatin inhibitors have been shown to reverse fibrotic deposition. Since CT-1 is an inhibitory cytokine that activates similar downstream effectors as TGF- $\beta$  it may be used as an anti-fibrotic drug. Additionally, CT-1 maintains undifferentiated muscle, thus it may have another role in maintaining satellite cells.

In this thesis, the molecular role of an AP-1 subunit (Fra-2) has been studied and linked to cellular signalling pathways. The identification of Fra-2 as a new marker and also potential regulator of satellite stem cells in mature skeletal muscle offers new insight and possibilities for muscle maintenance and regeneration in the physiology and pathophysiology of the muscular system.

## References

- Abe, T., Takano, K., Suzuki, A., Shimada, Y., Inagaki, M., Sato, N., Obinata, T., and Endo, T. (2004). Myocyte differentiation generates nuclear invaginations traversed by myofibrils associating with sarcomeric protein mRNAs. *J Cell Sci* *117*, 6523-6534.
- Abell, A.N., Granger, D.A., Johnson, N.L., Vincent-Jordan, N., Dibble, C.F., and Johnson, G.L. (2009). Trophoblast stem cell maintenance by fibroblast growth factor 4 requires MEKK4 activation of Jun N-terminal kinase. *Molecular and cellular biology* *29*, 2748-2761.
- Acquaviva, C., Brockly, F., Ferrara, P., Bossis, G., Salvat, C., Jariel-Encontre, I., and Piechaczyk, M. (2001). Identification of a C-terminal tripeptide motif involved in the control of rapid proteasomal degradation of c-Fos proto-oncoprotein during the G(0)-to-S phase transition. *Oncogene* *20*, 7563-7572.
- Adi, S., Bin-Abbas, B., Wu, N.Y., and Rosenthal, S.M. (2002). Early stimulation and late inhibition of extracellular signal-regulated kinase 1/2 phosphorylation by IGF-I: a potential mechanism mediating the switch in IGF-I action on skeletal muscle cell differentiation. *Endocrinology* *143*, 511-516.
- Allegretto, E.A., Smeal, T., Angel, P., Spiegelman, B.M., and Karin, M. (1990). DNA-binding activity of Jun is increased through its interaction with Fos. *Journal of cellular biochemistry* *42*, 193-206.
- Allen, D.L., Sartorius, C.A., Sycuro, L.K., and Leinwand, L.A. (2001). Different pathways regulate expression of the skeletal myosin heavy chain genes. *J Biol Chem* *276*, 43524-43533.
- Allen, R.E., and Boxhorn, L.K. (1987). Inhibition of skeletal muscle satellite cell differentiation by transforming growth factor-beta. *Journal of cellular physiology* *133*, 567-572.
- Alli, N.S., Yang, E.C., Miyake, T., Aziz, A., Collins-Hooper, H., Patel, K., and McDermott, J.C. (2013). Signal-dependent fra-2 regulation in skeletal muscle reserve and satellite cells. *Cell death & disease* *4*, e692.

Anderson, J.E., Wozniak, A.C., and Mizunoya, W. (2012). Single muscle-fiber isolation and culture for cellular, molecular, pharmacological, and evolutionary studies. *Methods in molecular biology* 798, 85-102.

Andreucci, J.J., Grant, D., Cox, D.M., Tomc, L.K., Prywes, R., Goldhamer, D.J., Rodrigues, N., Bedard, P.A., and McDermott, J.C. (2002). Composition and function of AP-1 transcription complexes during muscle cell differentiation. *J Biol Chem* 277, 16426-16432.

Angel, P., Imagawa, M., Chiu, R., Stein, B., Imbra, R.J., Rahmsdorf, H.J., Jonat, C., Herrlich, P., and Karin, M. (1987). Phorbol ester-inducible genes contain a common cis element recognized by a TPA-modulated trans-acting factor. *Cell* 49, 729-739.

Angel, P., and Karin, M. (1991). The role of Jun, Fos and the AP-1 complex in cell-proliferation and transformation. *Biochimica et biophysica acta* 1072, 129-157.

Angel, P., Szabowski, A., and Schorpp-Kistner, M. (2001). Function and regulation of AP-1 subunits in skin physiology and pathology. *Oncogene* 20, 2413-2423.

Arnold, H.H., and Braun, T. (1996). Targeted inactivation of myogenic factor genes reveals their role during mouse myogenesis: a review. *Int J Dev Biol* 40, 345-353.

Arnold, H.H., and Winter, B. (1998). Muscle differentiation: more complexity to the network of myogenic regulators. *Curr Opin Genet Dev* 8, 539-544.

Asakura, A., Lyons, G.E., and Tapscott, S.J. (1995). The regulation of MyoD gene expression: conserved elements mediate expression in embryonic axial muscle. *Developmental biology* 171, 386-398.

Asakura, A., Seale, P., Girgis-Gabardo, A., and Rudnicki, M.A. (2002). Myogenic specification of side population cells in skeletal muscle. *The Journal of cell biology* 159, 123-134.

Bakin, A.V., and Curran, T. (1999). Role of DNA 5-methylcytosine transferase in cell transformation by fos. *Science* 283, 387-390.

Bakiri, L., Lallemand, D., Bossy-Wetzel, E., and Yaniv, M. (2000). Cell cycle-dependent variations in c-Jun and JunB phosphorylation: a role in the control of cyclin D1 expression. *The EMBO journal* *19*, 2056-2068.

Basbous, J., Jariel-Encontre, I., Gomard, T., Bossis, G., and Piechaczyk, M. (2008). Ubiquitin-independent- versus ubiquitin-dependent proteasomal degradation of the c-Fos and Fra-1 transcription factors: is there a unique answer? *Biochimie* *90*, 296-305.

Becker, J.R., Dorman, C.M., McClafferty, T.M., and Johnson, S.E. (2001). Characterization of a dominant inhibitory E47 protein that suppresses C2C12 myogenesis. *Exp Cell Res* *267*, 135-143.

Bengal, E., Ransone, L., Scharfmann, R., Dwarki, V.J., Tapscott, S.J., Weintraub, H., and Verma, I.M. (1992). Functional antagonism between c-Jun and MyoD proteins: a direct physical association. *Cell* *68*, 507-519.

Bennett, A.M., and Tonks, N.K. (1997). Regulation of distinct stages of skeletal muscle differentiation by mitogen-activated protein kinases. *Science* *278*, 1288-1291.

Bergstrom, D.A., and Tapscott, S.J. (2001). Molecular distinction between specification and differentiation in the myogenic basic helix-loop-helix transcription factor family. *Molecular and cellular biology* *21*, 2404-2412.

Berkes, C.A., and Tapscott, S.J. (2005). MyoD and the transcriptional control of myogenesis. *Semin Cell Dev Biol* *16*, 585-595.

Bhatnagar, S., Kumar, A., Makonchuk, D.Y., Li, H., and Kumar, A. (2010). Transforming growth factor-beta-activated kinase 1 is an essential regulator of myogenic differentiation. *J Biol Chem* *285*, 6401-6411.

Bischoff, R. (1975). Regeneration of single skeletal muscle fibers in vitro. *The Anatomical record* *182*, 215-235.

Bischoff, R. (1986). Proliferation of muscle satellite cells on intact myofibers in culture. *Developmental biology* *115*, 129-139.

Biteau, B., and Jasper, H. (2011). EGF signaling regulates the proliferation of intestinal stem cells in *Drosophila*. *Development* *138*, 1045-1055.

- Bohmann, D., Bos, T.J., Admon, A., Nishimura, T., Vogt, P.K., and Tjian, R. (1987). Human proto-oncogene c-jun encodes a DNA binding protein with structural and functional properties of transcription factor AP-1. *Science* 238, 1386-1392.
- Bordet, T., Schmalbruch, H., Pettmann, B., Hagege, A., Castelnau-Ptakhine, L., Kahn, A., and Haase, G. (1999). Adenoviral cardiotrophin-1 gene transfer protects pmn mice from progressive motor neuronopathy. *The Journal of clinical investigation* 104, 1077-1085.
- Borycki, A.G., Brunk, B., Tajbakhsh, S., Buckingham, M., Chiang, C., and Emerson, C.P., Jr. (1999). Sonic hedgehog controls epaxial muscle determination through Myf5 activation. *Development* 126, 4053-4063.
- Bossy-Wetzell, E., Bravo, R., and Hanahan, D. (1992). Transcription factors junB and c-jun are selectively up-regulated and functionally implicated in fibrosarcoma development. *Genes & development* 6, 2340-2351.
- Bozec, A., Bakiri, L., Jimenez, M., Schinke, T., Amling, M., and Wagner, E.F. (2010). Fra-2/AP-1 controls bone formation by regulating osteoblast differentiation and collagen production. *The Journal of cell biology* 190, 1093-1106.
- Brar, B.K., Stephanou, A., Pennica, D., and Latchman, D.S. (2001). CT-1 mediated cardioprotection against ischaemic re-oxygenation injury is mediated by PI3 kinase, Akt and MEK1/2 pathways. *Cytokine* 16, 93-96.
- Braun, T., Bober, E., Rudnicki, M.A., Jaenisch, R., and Arnold, H.H. (1994). MyoD expression marks the onset of skeletal myogenesis in Myf-5 mutant mice. *Development* 120, 3083-3092.
- Brennan, T.J., Edmondson, D.G., Li, L., and Olson, E.N. (1991). Transforming growth factor beta represses the actions of myogenin through a mechanism independent of DNA binding. *Proc Natl Acad Sci U S A* 88, 3822-3826.
- Bromberg, J.F., Wrzeszczynska, M.H., Devgan, G., Zhao, Y., Pestell, R.G., Albanese, C., and Darnell, J.E., Jr. (1999). Stat3 as an oncogene. *Cell* 98, 295-303.
- Brown, J.R., Ye, H., Bronson, R.T., Dikkes, P., and Greenberg, M.E. (1996). A defect in nurturing in mice lacking the immediate early gene fosB. *Cell* 86, 297-309.

Buchberger, A., and Arnold, H.H. (1999). The MADS domain containing transcription factor cMef2a is expressed in heart and skeletal muscle during embryonic chick development. *Dev Genes Evol* 209, 376-381.

Buckingham, M. (2001). Skeletal muscle formation in vertebrates. *Curr Opin Genet Dev* 11, 440-448.

Buckingham, M., Bajard, L., Chang, T., Daubas, P., Hadchouel, J., Meilhac, S., Montarras, D., Rocancourt, D., and Relaix, F. (2003). The formation of skeletal muscle: from somite to limb. *J Anat* 202, 59-68.

Buckingham, M., and Montarras, D. (2008). Skeletal muscle stem cells. *Current opinion in genetics & development* 18, 330-336.

Cabane, C., Englaro, W., Yeow, K., Ragno, M., and Derijard, B. (2003). Regulation of C2C12 myogenic terminal differentiation by MKK3/p38alpha pathway. *Am J Physiol Cell Physiol* 284, C658-666.

Cao, Y., Yao, Z., Sarkar, D., Lawrence, M., Sanchez, G.J., Parker, M.H., MacQuarrie, K.L., Davison, J., Morgan, M.T., Ruzzo, W.L., *et al.* (2010). Genome-wide MyoD binding in skeletal muscle cells: a potential for broad cellular reprogramming. *Dev Cell* 18, 662-674.

Cao, Y., Zhao, Z., Gruszczynska-Biegala, J., and Zolkiewska, A. (2003). Role of metalloprotease disintegrin ADAM12 in determination of quiescent reserve cells during myogenic differentiation in vitro. *Molecular and cellular biology* 23, 6725-6738.

Carey, I., and Zehner, Z.E. (1995). Regulation of chicken vimentin gene expression by serum, phorbol ester, and growth factors: identification of a novel fibroblast growth factor-inducible element. *Cell growth & differentiation : the molecular biology journal of the American Association for Cancer Research* 6, 899-908.

Carter, R., Cosenza, S.C., Pena, A., Lipson, K., Soprano, D.R., and Soprano, K.J. (1991). A potential role for c-jun in cell cycle progression through late G1 and S. *Oncogene* 6, 229-235.

- Celik, A., Sahin, S., Koc, F., Karayakali, M., Sahin, M., Benli, I., Kadi, H., Burucu, T., Ceyhan, K., and Erkorkmaz, U. (2012). Cardiotrophin-1 plasma levels are increased in patients with diastolic heart failure. *Medical science monitor : international medical journal of experimental and clinical research* 18, CR25-31.
- Chan, X.C., McDermott, J.C., and Siu, K.W. (2007). Identification of secreted proteins during skeletal muscle development. *Journal of proteome research* 6, 698-710.
- Chen, A.E., Ginty, D.D., and Fan, C.M. (2005). Protein kinase A signalling via CREB controls myogenesis induced by Wnt proteins. *Nature* 433, 317-322.
- Chen, C., and Sytkowski, A.J. (2004). Erythropoietin regulation of Raf-1 and MEK: evidence for a Ras-independent mechanism. *Blood* 104, 73-80.
- Cheng, T.C., Tseng, B.S., Merlie, J.P., Klein, W.H., and Olson, E.N. (1995). Activation of the myogenin promoter during mouse embryogenesis in the absence of positive autoregulation. *Proceedings of the National Academy of Sciences of the United States of America* 92, 561-565.
- Chinenov, Y., and Kerppola, T.K. (2001). Close encounters of many kinds: Fos-Jun interactions that mediate transcription regulatory specificity. *Oncogene* 20, 2438-2452.
- Coleman, M.E., DeMayo, F., Yin, K.C., Lee, H.M., Geske, R., Montgomery, C., and Schwartz, R.J. (1995). Myogenic vector expression of insulin-like growth factor I stimulates muscle cell differentiation and myofiber hypertrophy in transgenic mice. *J Biol Chem* 270, 12109-12116.
- Conboy, I.M., and Rando, T.A. (2002). The regulation of Notch signaling controls satellite cell activation and cell fate determination in postnatal myogenesis. *Developmental cell* 3, 397-409.
- Conejo, R., and Lorenzo, M. (2001). Insulin signaling leading to proliferation, survival, and membrane ruffling in C2C12 myoblasts. *J Cell Physiol* 187, 96-108.
- Conejo, R., Valverde, A.M., Benito, M., and Lorenzo, M. (2001). Insulin produces myogenesis in C2C12 myoblasts by induction of NF-kappaB and downregulation of AP-1 activities. *Journal of cellular physiology* 186, 82-94.

Conway, K., Pin, C., Kiernan, J.A., and Merrifield, P. (2004). The E protein HEB is preferentially expressed in developing muscle. *Differentiation; research in biological diversity* 72, 327-340.

Cook, S.J., Aziz, N., and McMahon, M. (1999). The repertoire of fos and jun proteins expressed during the G1 phase of the cell cycle is determined by the duration of mitogen-activated protein kinase activation. *Molecular and cellular biology* 19, 330-341.

Cossu, G., Kelly, R., Tajbakhsh, S., Di Donna, S., Vivarelli, E., and Buckingham, M. (1996). Activation of different myogenic pathways: myf-5 is induced by the neural tube and MyoD by the dorsal ectoderm in mouse paraxial mesoderm. *Development* 122, 429-437.

Cox, D.M., Du, M., Marback, M., Yang, E.C., Chan, J., Siu, K.W., and McDermott, J.C. (2003). Phosphorylation motifs regulating the stability and function of myocyte enhancer factor 2A. *The Journal of biological chemistry* 278, 15297-15303.

Cuenda, A., and Cohen, P. (1999). Stress-activated protein kinase-2/p38 and a rapamycin-sensitive pathway are required for C2C12 myogenesis. *The Journal of biological chemistry* 274, 4341-4346.

Czifra, G., Toth, I.B., Marincsak, R., Juhasz, I., Kovacs, I., Acs, P., Kovacs, L., Blumberg, P.M., and Biro, T. (2006). Insulin-like growth factor-I-coupled mitogenic signaling in primary cultured human skeletal muscle cells and in C2C12 myoblasts. A central role of protein kinase Cdelta. *Cellular signalling* 18, 1461-1472.

D'Alessandris, C., Lauro, R., Presta, I., and Sesti, G. (2007). C-reactive protein induces phosphorylation of insulin receptor substrate-1 on Ser307 and Ser 612 in L6 myocytes, thereby impairing the insulin signalling pathway that promotes glucose transport. *Diabetologia* 50, 840-849.

Daury, L., Busson, M., Tourkine, N., Casas, F., Cassar-Malek, I., Wrutniak-Cabello, C., Castellazzi, M., and Cabello, G. (2001). Opposing functions of ATF2 and Fos-like transcription factors in c-Jun-mediated myogenin expression and terminal differentiation of avian myoblasts. *Oncogene* 20, 7998-8008.

Davis, R.L., Cheng, P.F., Lassar, A.B., and Weintraub, H. (1990). The MyoD DNA binding domain contains a recognition code for muscle-specific gene activation. *Cell* 60, 733-746.



Davis, R.L., Weintraub, H., and Lassar, A.B. (1987). Expression of a single transfected cDNA converts fibroblasts to myoblasts. *Cell* 51, 987-1000.

de la Serna, I.L., Ohkawa, Y., Berkes, C.A., Bergstrom, D.A., Dacwag, C.S., Tapscott, S.J., and Imbalzano, A.N. (2005). MyoD targets chromatin remodeling complexes to the myogenin locus prior to forming a stable DNA-bound complex. *Molecular and cellular biology* 25, 3997-4009.

Dellavalle, A., Maroli, G., Covarello, D., Azzoni, E., Innocenzi, A., Perani, L., Antonini, S., Sambasivan, R., Brunelli, S., Tajbakhsh, S., *et al.* (2011). Pericytes resident in postnatal skeletal muscle differentiate into muscle fibres and generate satellite cells. *Nature communications* 2, 499.

Dellavalle, A., Sampaolesi, M., Tonlorenzi, R., Tagliafico, E., Sacchetti, B., Perani, L., Innocenzi, A., Galvez, B.G., Messina, G., Morosetti, R., *et al.* (2007). Pericytes of human skeletal muscle are myogenic precursors distinct from satellite cells. *Nature cell biology* 9, 255-267.

Derijard, B., Hibi, M., Wu, I.H., Barrett, T., Su, B., Deng, T., Karin, M., and Davis, R.J. (1994). JNK1: a protein kinase stimulated by UV light and Ha-Ras that binds and phosphorylates the c-Jun activation domain. *Cell* 76, 1025-1037.

Diefenbacher, M., Sekula, S., Heilbock, C., Maier, J.V., Litfin, M., van Dam, H., Castellazzi, M., Herrlich, P., and Kassel, O. (2008). Restriction to Fos family members of Trip6-dependent coactivation and glucocorticoid receptor-dependent trans-repression of activator protein-1. *Molecular endocrinology* 22, 1767-1780.

Dilworth, F.J., Seaver, K.J., Fishburn, A.L., Htet, S.L., and Tapscott, S.J. (2004). In vitro transcription system delineates the distinct roles of the coactivators pCAF and p300 during MyoD/E47-dependent transactivation. *Proceedings of the National Academy of Sciences of the United States of America* 101, 11593-11598.

Dodou, E., Xu, S.M., and Black, B.L. (2003). *mef2c* is activated directly by myogenic basic helix-loop-helix proteins during skeletal muscle development in vivo. *Mech Dev* 120, 1021-1032.

Donoviel, D.B., Shield, M.A., Buskin, J.N., Haugen, H.S., Clegg, C.H., and Hauschka, S.D. (1996). Analysis of muscle creatine kinase gene regulatory elements in skeletal and cardiac muscles of transgenic mice. *Molecular and cellular biology* 16, 1649-1658.

Du, M., Perry, R.L., Nowacki, N.B., Gordon, J.W., Salma, J., Zhao, J., Aziz, A., Chan, J., Siu, K.W., and McDermott, J.C. (2008). Protein kinase A represses skeletal myogenesis by targeting myocyte enhancer factor 2D. *Molecular and cellular biology* 28, 2952-2970.

Edmondson, D.G., Lyons, G.E., Martin, J.F., and Olson, E.N. (1994). Mef2 gene expression marks the cardiac and skeletal muscle lineages during mouse embryogenesis. *Development* 120, 1251-1263.

Edmondson, D.G., and Olson, E.N. (1989). A gene with homology to the myc similarity region of MyoD1 is expressed during myogenesis and is sufficient to activate the muscle differentiation program. *Genes & development* 3, 628-640.

Eferl, R., Hasselblatt, P., Rath, M., Popper, H., Zenz, R., Komnenovic, V., Idarraga, M.H., Kenner, L., and Wagner, E.F. (2008). Development of pulmonary fibrosis through a pathway involving the transcription factor Fra-2/AP-1. *Proceedings of the National Academy of Sciences of the United States of America* 105, 10525-10530.

Eferl, R., Hoebertz, A., Schilling, A.F., Rath, M., Karreth, F., Kenner, L., Amling, M., and Wagner, E.F. (2004). The Fos-related antigen Fra-1 is an activator of bone matrix formation. *The EMBO journal* 23, 2789-2799.

Eferl, R., Sibilia, M., Hilberg, F., Fuchsbichler, A., Kufferath, I., Guertl, B., Zenz, R., Wagner, E.F., and Zatloukal, K. (1999). Functions of c-Jun in liver and heart development. *The Journal of cell biology* 145, 1049-1061.

Eferl, R., Zenz, R., Theussl, H.C., and Wagner, E.F. (2007). Simultaneous generation of fra-2 conditional and fra-2 knock-out mice. *Genesis* 45, 447-451.

Engert, J.C., Berglund, E.B., and Rosenthal, N. (1996). Proliferation precedes differentiation in IGF-I-stimulated myogenesis. *The Journal of cell biology* 135, 431-440.

Eriksson, M., and Leppa, S. (2002). Mitogen-activated protein kinases and activator protein 1 are required for proliferation and cardiomyocyte differentiation of P19 embryonal carcinoma cells. *The Journal of biological chemistry* 277, 15992-16001.

- Fleischmann, A., Hafezi, F., Elliott, C., Reme, C.E., Ruther, U., and Wagner, E.F. (2000). Fra-1 replaces c-Fos-dependent functions in mice. *Genes & development* *14*, 2695-2700.
- Franz, T., and Kothary, R. (1993). Characterization of the neural crest defect in Splotch (Sp1H) mutant mice using a lacZ transgene. *Brain research Developmental brain research* *72*, 99-105.
- Freed, D.H., Borowiec, A.M., Angelovska, T., and Dixon, I.M. (2003a). Induction of protein synthesis in cardiac fibroblasts by cardiotrophin-1: integration of multiple signaling pathways. *Cardiovascular research* *60*, 365-375.
- Freed, D.H., Cunnington, R.H., Dangerfield, A.L., Sutton, J.S., and Dixon, I.M. (2005). Emerging evidence for the role of cardiotrophin-1 in cardiac repair in the infarcted heart. *Cardiovascular research* *65*, 782-792.
- Freed, D.H., Moon, M.C., Borowiec, A.M., Jones, S.C., Zahradka, P., and Dixon, I.M. (2003b). Cardiotrophin-1: expression in experimental myocardial infarction and potential role in post-MI wound healing. *Molecular and cellular biochemistry* *254*, 247-256.
- Fux, C., Langer, D., and Fussenegger, M. (2004). Dual-regulated myoD- and msx1-based interventions in C2C12-derived cells enable precise myogenic/osteogenic/adipogenic lineage control. *J Gene Med* *6*, 1159-1169.
- Gerber, A.N., Klesert, T.R., Bergstrom, D.A., and Tapscott, S.J. (1997). Two domains of MyoD mediate transcriptional activation of genes in repressive chromatin: a mechanism for lineage determination in myogenesis. *Genes & development* *11*, 436-450.
- Gersch, R.P., and Hadjiargyrou, M. (2009). *Mustn1* is expressed during chondrogenesis and is necessary for chondrocyte proliferation and differentiation in vitro. *Bone* *45*, 330-338.
- Gherzi, R., Trabucchi, M., Ponassi, M., Gallouzi, I.E., Rosenfeld, M.G., and Briata, P. (2010). Akt2-mediated phosphorylation of Pitx2 controls *Ccnd1* mRNA decay during muscle cell differentiation. *Cell death and differentiation* *17*, 975-983.

Gkaliagkousi, E., Gavriilaki, E., Nikolaidou, B., Chatzopoulou, F., Anyfanti, P., Triantafyllou, A., Petidis, K., Zamboulis, C., and Douma, S. (2014). Association between cardiotrophin 1 levels and central blood pressure in untreated patients with essential hypertension. *American journal of hypertension* 27, 651-655.

Gordon, J.W., Pagiatakis, C., Salma, J., Du, M., Andreucci, J.J., Zhao, J., Hou, G., Perry, R.L., Dan, Q., Courtman, D., *et al.* (2009). Protein kinase A-regulated assembly of a MEF2{middle dot}HDAC4 repressor complex controls c-Jun expression in vascular smooth muscle cells. *The Journal of biological chemistry* 284, 19027-19042.

Grifone, R., Demignon, J., Houbron, C., Souil, E., Niro, C., Seller, M.J., Hamard, G., and Maire, P. (2005). Six1 and Six4 homeoproteins are required for Pax3 and Mrf expression during myogenesis in the mouse embryo. *Development* 132, 2235-2249.

Grigoriadis, A.E., Schellander, K., Wang, Z.Q., and Wagner, E.F. (1993). Osteoblasts are target cells for transformation in c-fos transgenic mice. *The Journal of cell biology* 122, 685-701.

Gros, J., Manceau, M., Thome, V., and Marcelle, C. (2005). A common somitic origin for embryonic muscle progenitors and satellite cells. *Nature* 435, 954-958.

Gruda, M.C., Kovary, K., Metz, R., and Bravo, R. (1994). Regulation of Fra-1 and Fra-2 phosphorylation differs during the cell cycle of fibroblasts and phosphorylation in vitro by MAP kinase affects DNA binding activity. *Oncogene* 9, 2537-2547.

Gu, W., Schneider, J.W., Condorelli, G., Kaushal, S., Mahdavi, V., and Nadal-Ginard, B. (1993). Interaction of myogenic factors and the retinoblastoma protein mediates muscle cell commitment and differentiation. *Cell* 72, 309-324.

Gupta, S., Campbell, D., Derijard, B., and Davis, R.J. (1995). Transcription factor ATF2 regulation by the JNK signal transduction pathway. *Science* 267, 389-393.

Gustafsson, M.K., Pan, H., Pinney, D.F., Liu, Y., Lewandowski, A., Epstein, D.J., and Emerson, C.P., Jr. (2002). Myf5 is a direct target of long-range Shh signaling and Gli regulation for muscle specification. *Genes & development* 16, 114-126.

Haba Gde, L., Cooper, G.W., and Elting, V. (1966). Hormonal requirements for myogenesis of striated muscle in vitro: insulin and somatotropin. *Proc Natl Acad Sci U S A* 56, 1719-1723.

- Halazonetis, T.D., Georgopoulos, K., Greenberg, M.E., and Leder, P. (1988). c-Jun dimerizes with itself and with c-Fos, forming complexes of different DNA binding affinities. *Cell* 55, 917-924.
- Han, J., Jiang, Y., Li, Z., Kravchenko, V.V., and Ulevitch, R.J. (1997). Activation of the transcription factor MEF2C by the MAP kinase p38 in inflammation. *Nature* 386, 296-299.
- Heinrich, P.C., Behrmann, I., Haan, S., Hermanns, H.M., Muller-Newen, G., and Schaper, F. (2003). Principles of interleukin (IL)-6-type cytokine signalling and its regulation. *The Biochemical journal* 374, 1-20.
- Hibi, M., Lin, A., Smeal, T., Minden, A., and Karin, M. (1993). Identification of an oncoprotein- and UV-responsive protein kinase that binds and potentiates the c-Jun activation domain. *Genes & development* 7, 2135-2148.
- Hierlihy, A.M., Seale, P., Lobe, C.G., Rudnicki, M.A., and Megeney, L.A. (2002). The post-natal heart contains a myocardial stem cell population. *FEBS letters* 530, 239-243.
- Hill, C.S., Wynne, J., and Treisman, R. (1994). Serum-regulated transcription by serum response factor (SRF): a novel role for the DNA binding domain. *The EMBO journal* 13, 5421-5432.
- Hirsinger, E., Malapert, P., Dubrulle, J., Delfini, M.C., Duprez, D., Henrique, D., Ish-Horowicz, D., and Pourquie, O. (2001). Notch signalling acts in postmitotic avian myogenic cells to control MyoD activation. *Development* 128, 107-116.
- Holtmann, B., Wiese, S., Samsam, M., Grohmann, K., Pennica, D., Martini, R., and Sendtner, M. (2005). Triple knock-out of CNTF, LIF, and CT-1 defines cooperative and distinct roles of these neurotrophic factors for motoneuron maintenance and function. *The Journal of neuroscience : the official journal of the Society for Neuroscience* 25, 1778-1787.
- Hung, H.C., Lu, F.H., Ou, H.Y., Wu, H.T., Wu, J.S., Yang, Y.C., and Chang, C.J. (2013). Increased cardiotrophin-1 in subjects with impaired glucose tolerance and newly diagnosed diabetes. *International journal of cardiology* 169, e33-34.

- Illario, M., Monaco, S., Cavallo, A.L., Esposito, I., Formisano, P., D'Andrea, L., Cipolletta, E., Trimarco, B., Fenzi, G., Rossi, G., *et al.* (2009). Calcium-calmodulin-dependent kinase II (CaMKII) mediates insulin-stimulated proliferation and glucose uptake. *Cellular signalling* *21*, 786-792.
- Irintchev, A., Zeschnigk, M., Starzinski-Powitz, A., and Wernig, A. (1994). Expression pattern of M-cadherin in normal, denervated, and regenerating mouse muscles. *Developmental dynamics : an official publication of the American Association of Anatomists* *199*, 326-337.
- Jackson, J.D., Zhou, G., Kuszynski, C.A., Cai, J., and Fox, I.J. (2002). Induction of chimerism in mice using human MHC class I-mismatched Hoechst 33342 side population donor stem cells. *Cell transplantation* *11*, 779-785.
- Janknecht, R., Ernst, W.H., Pingoud, V., and Nordheim, A. (1993). Activation of ternary complex factor Elk-1 by MAP kinases. *The EMBO journal* *12*, 5097-5104.
- Jarvis, E.E., Clark, K.L., and Sprague, G.F., Jr. (1989). The yeast transcription activator PRTF, a homolog of the mammalian serum response factor, is encoded by the MCM1 gene. *Genes & development* *3*, 936-945.
- Jin, H., Yang, R., Keller, G.A., Ryan, A., Ko, A., Finkle, D., Swanson, T.A., Li, W., Pennica, D., Wood, W.I., *et al.* (1996). In vivo effects of cardiotrophin-1. *Cytokine* *8*, 920-926.
- Jo, C., Kim, H., Jo, I., Choi, I., Jung, S.C., Kim, J., Kim, S.S., and Jo, S.A. (2005). Leukemia inhibitory factor blocks early differentiation of skeletal muscle cells by activating ERK. *Biochimica et biophysica acta* *1743*, 187-197.
- Jochum, W., Passegue, E., and Wagner, E.F. (2001). AP-1 in mouse development and tumorigenesis. *Oncogene* *20*, 2401-2412.
- Johnson, R., Spiegelman, B., Hanahan, D., and Wisdom, R. (1996). Cellular transformation and malignancy induced by ras require c-jun. *Molecular and cellular biology* *16*, 4504-4511.
- Johnson, R.S., van Lingen, B., Papaioannou, V.E., and Spiegelman, B.M. (1993). A null mutation at the c-jun locus causes embryonic lethality and retarded cell growth in culture. *Genes & development* *7*, 1309-1317.

Johnson, S.E., Winner, D.G., Jr., and Wang, X. (2006). Ran binding protein 9 interacts with Raf kinase but does not contribute to downstream ERK1/2 activation in skeletal myoblasts. *Biochem Biophys Res Commun* 340, 409-416.

Jones, N.C., Fedorov, Y.V., Rosenthal, R.S., and Olwin, B.B. (2001). ERK1/2 is required for myoblast proliferation but is dispensable for muscle gene expression and cell fusion. *Journal of cellular physiology* 186, 104-115.

Kablar, B., Krastel, K., Ying, C., Asakura, A., Tapscott, S.J., and Rudnicki, M.A. (1997). MyoD and Myf-5 differentially regulate the development of limb versus trunk skeletal muscle. *Development* 124, 4729-4738.

Kablar, B., Krastel, K., Ying, C., Tapscott, S.J., Goldhamer, D.J., and Rudnicki, M.A. (1999). Myogenic determination occurs independently in somites and limb buds. *Developmental biology* 206, 219-231.

Kaliman, P., Vinals, F., Testar, X., Palacin, M., and Zorzano, A. (1996). Phosphatidylinositol 3-kinase inhibitors block differentiation of skeletal muscle cells. *J Biol Chem* 271, 19146-19151.

Kami, K., Morikawa, Y., Sekimoto, M., and Senba, E. (2000). Gene expression of receptors for IL-6, LIF, and CNTF in regenerating skeletal muscles. *The journal of histochemistry and cytochemistry : official journal of the Histochemistry Society* 48, 1203-1213.

Kaptein, A., Paillard, V., and Saunders, M. (1996). Dominant negative stat3 mutant inhibits interleukin-6-induced Jak-STAT signal transduction. *The Journal of biological chemistry* 271, 5961-5964.

Kassar-Duchossoy, L., Gayraud-Morel, B., Gomes, D., Rocancourt, D., Buckingham, M., Shinin, V., and Tajbakhsh, S. (2004). Mrf4 determines skeletal muscle identity in Myf5:Myod double-mutant mice. *Nature* 431, 466-471.

Kataoka, Y., Matsumura, I., Ezoe, S., Nakata, S., Takigawa, E., Sato, Y., Kawasaki, A., Yokota, T., Nakajima, K., Felsani, A., *et al.* (2003). Reciprocal inhibition between MyoD and STAT3 in the regulation of growth and differentiation of myoblasts. *J Biol Chem* 278, 44178-44187.

- Kaushal, S., Schneider, J.W., Nadal-Ginard, B., and Mahdavi, V. (1994). Activation of the myogenic lineage by MEF2A, a factor that induces and cooperates with MyoD. *Science* 266, 1236-1240.
- Kenner, L., Hoebertz, A., Beil, F.T., Keon, N., Karreth, F., Eferl, R., Scheuch, H., Szremska, A., Amling, M., Schorpp-Kistner, M., *et al.* (2004). Mice lacking JunB are osteopenic due to cell-autonomous osteoblast and osteoclast defects. *The Journal of cell biology* 164, 613-623.
- Keren, A., Tamir, Y., and Bengal, E. (2006). The p38 MAPK signaling pathway: a major regulator of skeletal muscle development. *Mol Cell Endocrinol* 252, 224-230.
- Kim, C.H., Neiswender, H., Baik, E.J., Xiong, W.C., and Mei, L. (2008). Beta-catenin interacts with MyoD and regulates its transcription activity. *Molecular and cellular biology* 28, 2941-2951.
- Kishimoto, T., Akira, S., Narazaki, M., and Taga, T. (1995). Interleukin-6 family of cytokines and gp130. *Blood* 86, 1243-1254.
- Kitzmann, M., Vandromme, M., Schaeffer, V., Carnac, G., Labbe, J.C., Lamb, N., and Fernandez, A. (1999). cdk1- and cdk2-mediated phosphorylation of MyoD Ser200 in growing C2 myoblasts: role in modulating MyoD half-life and myogenic activity. *Molecular and cellular biology* 19, 3167-3176.
- Knudsen, E.S., Pazzagli, C., Born, T.L., Bertolaet, B.L., Knudsen, K.E., Arden, K.C., Henry, R.R., and Feramisco, J.R. (1998). Elevated cyclins and cyclin-dependent kinase activity in the rhabdomyosarcoma cell line RD. *Cancer Res* 58, 2042-2049.
- Kollias, H.D., Perry, R.L., Miyake, T., Aziz, A., and McDermott, J.C. (2006). Smad7 promotes and enhances skeletal muscle differentiation. *Molecular and cellular biology* 26, 6248-6260.
- Kook, S.H., Jeon, Y.M., Lim, S.S., Jang, M.J., Cho, E.S., Lee, S.Y., Choi, K.C., Kim, J.G., and Lee, J.C. (2013). Fibroblast growth factor-4 enhances proliferation of mouse embryonic stem cells via activation of c-Jun signaling. *PLoS one* 8, e71641.
- Kovary, K., and Bravo, R. (1991). The jun and fos protein families are both required for cell cycle progression in fibroblasts. *Molecular and cellular biology* 11, 4466-4472.



Krause, M.P., Moradi, J., Coleman, S.K., D'Souza, D.M., Liu, C., Kronenberg, M.S., Rowe, D.W., Hawke, T.J., and Hadjiargyrou, M. (2013). A novel GFP reporter mouse reveals *Mustn1* expression in adult regenerating skeletal muscle, activated satellite cells and differentiating myoblasts. *Acta physiologica* 208, 180-190.

Kuang, S., Charge, S.B., Seale, P., Huh, M., and Rudnicki, M.A. (2006). Distinct roles for *Pax7* and *Pax3* in adult regenerative myogenesis. *The Journal of cell biology* 172, 103-113.

Kuang, S., Kuroda, K., Le Grand, F., and Rudnicki, M.A. (2007). Asymmetric self-renewal and commitment of satellite stem cells in muscle. *Cell* 129, 999-1010.

Lamph, W.W., Wamsley, P., Sassone-Corsi, P., and Verma, I.M. (1988). Induction of proto-oncogene *JUN/AP-1* by serum and TPA. *Nature* 334, 629-631.

Lassar, A.B., Buskin, J.N., Lockshon, D., Davis, R.L., Apone, S., Hauschka, S.D., and Weintraub, H. (1989). *MyoD* is a sequence-specific DNA binding protein requiring a region of myc homology to bind to the muscle creatine kinase enhancer. *Cell* 58, 823-831.

Lassar, A.B., Paterson, B.M., and Weintraub, H. (1986). Transfection of a DNA locus that mediates the conversion of 10T1/2 fibroblasts to myoblasts. *Cell* 47, 649-656.

Le Grand, F., Jones, A.E., Seale, V., Scime, A., and Rudnicki, M.A. (2009). *Wnt7a* activates the planar cell polarity pathway to drive the symmetric expansion of satellite stem cells. *Cell Stem Cell* 4, 535-547.

Lee, W., Haslinger, A., Karin, M., and Tjian, R. (1987a). Activation of transcription by two factors that bind promoter and enhancer sequences of the human metallothionein gene and SV40. *Nature* 325, 368-372.

Lee, W., Mitchell, P., and Tjian, R. (1987b). Purified transcription factor AP-1 interacts with TPA-inducible enhancer elements. *Cell* 49, 741-752.

Lehtinen, S.K., Rahkila, P., Helenius, M., Korhonen, P., and Salminen, A. (1996). Down-regulation of transcription factors AP-1, Sp-1, and NF-kappa B precedes myocyte differentiation. *Biochemical and biophysical research communications* 229, 36-43.

Lemerrier, C., To, R.Q., Carrasco, R.A., and Konieczny, S.F. (1998). The basic helix-loop-helix transcription factor Mist1 functions as a transcriptional repressor of myoD. *The EMBO journal* 17, 1412-1422.

Li, B., Tournier, C., Davis, R.J., and Flavell, R.A. (1999). Regulation of IL-4 expression by the transcription factor JunB during T helper cell differentiation. *The EMBO journal* 18, 420-432.

Li, J., and Johnson, S.E. (2006). ERK2 is required for efficient terminal differentiation of skeletal myoblasts. *Biochemical and biophysical research communications* 345, 1425-1433.

Lian, J.B., Stein, G.S., Bortell, R., and Owen, T.A. (1991). Phenotype suppression: a postulated molecular mechanism for mediating the relationship of proliferation and differentiation by Fos/Jun interactions at AP-1 sites in steroid responsive promoter elements of tissue-specific genes. *Journal of cellular biochemistry* 45, 9-14.

Liao, Z., Brar, B.K., Cai, Q., Stephanou, A., O'Leary, R.M., Pennica, D., Yellon, D.M., and Latchman, D.S. (2002). Cardiotrophin-1 (CT-1) can protect the adult heart from injury when added both prior to ischaemia and at reperfusion. *Cardiovascular research* 53, 902-910.

Liu, C., Gersch, R.P., Hawke, T.J., and Hadjiargyrou, M. (2010). Silencing of *Mustn1* inhibits myogenic fusion and differentiation. *Am J Physiol Cell Physiol* 298, C1100-1108.

Liu, C., and Hadjiargyrou, M. (2006). Identification and characterization of the *Mustang* promoter: regulation by AP-1 during myogenic differentiation. *Bone* 39, 815-824.

Lluis, F., Ballestar, E., Suelves, M., Esteller, M., and Munoz-Canoves, P. (2005). E47 phosphorylation by p38 MAPK promotes MyoD/E47 association and muscle-specific gene transcription. *The EMBO journal* 24, 974-984.

Lluis, F., Perdiguero, E., Nebreda, A.R., and Munoz-Canoves, P. (2006). Regulation of skeletal muscle gene expression by p38 MAP kinases. *Trends in cell biology* 16, 36-44.

- Lombardo, F., Komatsu, D., and Hadjiargyrou, M. (2004). Molecular cloning and characterization of Mustang, a novel nuclear protein expressed during skeletal development and regeneration. *FASEB journal : official publication of the Federation of American Societies for Experimental Biology* 18, 52-61.
- Lu, M., and Krauss, R.S. (2010). N-cadherin ligation, but not Sonic hedgehog binding, initiates Cdo-dependent p38alpha/beta MAPK signaling in skeletal myoblasts. *Proceedings of the National Academy of Sciences of the United States of America* 107, 4212-4217.
- Machida, S., Spangenburg, E.E., and Booth, F.W. (2003). Forkhead transcription factor FoxO1 transduces insulin-like growth factor's signal to p27Kip1 in primary skeletal muscle satellite cells. *Journal of cellular physiology* 196, 523-531.
- Maki, Y., Bos, T.J., Davis, C., Starbuck, M., and Vogt, P.K. (1987). Avian sarcoma virus 17 carries the jun oncogene. *Proceedings of the National Academy of Sciences of the United States of America* 84, 2848-2852.
- Mandel, J.L., and Pearson, M.L. (1974). Insulin stimulates myogenesis in a rat myoblast line. *Nature* 251, 618-620.
- Mansour, S.J., Resing, K.A., Candi, J.M., Hermann, A.S., Gloor, J.W., Herskind, K.R., Wartmann, M., Davis, R.J., and Ahn, N.G. (1994). Mitogen-activated protein (MAP) kinase phosphorylation of MAP kinase kinase: determination of phosphorylation sites by mass spectrometry and site-directed mutagenesis. *Journal of biochemistry* 116, 304-314.
- Mansouri, A., Stoykova, A., Torres, M., and Gruss, P. (1996). Dysgenesis of cephalic neural crest derivatives in Pax7<sup>-/-</sup> mutant mice. *Development* 122, 831-838.
- Mauro, A. (1961). Satellite cell of skeletal muscle fibers. *The Journal of biophysical and biochemical cytology* 9, 493-495.
- McBride, K., Robitaille, L., Tremblay, S., Argentin, S., and Nemer, M. (1993). fos/jun repression of cardiac-specific transcription in quiescent and growth-stimulated myocytes is targeted at a tissue-specific cis element. *Molecular and cellular biology* 13, 600-612.

- McFarlane, C., Hennebry, A., Thomas, M., Plummer, E., Ling, N., Sharma, M., and Kambadur, R. (2008). Myostatin signals through Pax7 to regulate satellite cell self-renewal. *Exp Cell Res* 314, 317-329.
- McHenry, J.Z., Leon, A., Matthaei, K.I., and Cohen, D.R. (1998). Overexpression of fra-2 in transgenic mice perturbs normal eye development. *Oncogene* 17, 1131-1140.
- McKinsey, T.A., Zhang, C.L., and Olson, E.N. (2002). Signaling chromatin to make muscle. *Curr Opin Cell Biol* 14, 763-772.
- Milasincic, D.J., Calera, M.R., Farmer, S.R., and Pilch, P.F. (1996). Stimulation of C2C12 myoblast growth by basic fibroblast growth factor and insulin-like growth factor 1 can occur via mitogen-activated protein kinase-dependent and -independent pathways. *Molecular and cellular biology* 16, 5964-5973.
- Milde-Langosch, K. (2005). The Fos family of transcription factors and their role in tumourigenesis. *European journal of cancer* 41, 2449-2461.
- Minami, M., Koyama, T., Wakayama, Y., Fukuhara, S., and Mochizuki, N. (2011). EphrinA/EphA signal facilitates insulin-like growth factor-I-induced myogenic differentiation through suppression of the Ras/extracellular signal-regulated kinase 1/2 cascade in myoblast cell lines. *Molecular biology of the cell* 22, 3508-3519.
- Mitchell, K.J., Pannerec, A., Cadot, B., Parlakian, A., Besson, V., Gomes, E.R., Marazzi, G., and Sassoon, D.A. (2010). Identification and characterization of a non-satellite cell muscle resident progenitor during postnatal development. *Nat Cell Biol* 12, 257-266.
- Miyake, T., Alli, N.S., Aziz, A., Knudson, J., Fernando, P., Megeney, L.A., and McDermott, J.C. (2009). Cardiotrophin-1 maintains the undifferentiated state in skeletal myoblasts. *The Journal of biological chemistry* 284, 19679-19693.
- Miyake, T., Alli, N.S., and McDermott, J.C. (2010). Nuclear function of Smad7 promotes myogenesis. *Molecular and cellular biology* 30, 722-735.
- Molkentin, J.D., and Olson, E.N. (1996a). Combinatorial control of muscle development by basic helix-loop-helix and MADS-box transcription factors. *Proceedings of the National Academy of Sciences of the United States of America* 93, 9366-9373.

Molkentin, J.D., and Olson, E.N. (1996b). Defining the regulatory networks for muscle development. *Curr Opin Genet Dev* 6, 445-453.

Morooka, H., Bonventre, J.V., Pombo, C.M., Kyriakis, J.M., and Force, T. (1995). Ischemia and reperfusion enhance ATF-2 and c-Jun binding to cAMP response elements and to an AP-1 binding site from the c-jun promoter. *The Journal of biological chemistry* 270, 30084-30092.

Motohashi, N., Uezumi, A., Yada, E., Fukada, S., Fukushima, K., Imaizumi, K., Miyagoe-Suzuki, Y., and Takeda, S. (2008). Muscle CD31(-) CD45(-) side population cells promote muscle regeneration by stimulating proliferation and migration of myoblasts. *The American journal of pathology* 173, 781-791.

Mourikis, P., Sambasivan, R., Castel, D., Rocheteau, P., Bizzarro, V., and Tajbakhsh, S. (2012). A critical requirement for notch signaling in maintenance of the quiescent skeletal muscle stem cell state. *Stem cells* 30, 243-252.

Murakami, M., Sonobe, M.H., Ui, M., Kabuyama, Y., Watanabe, H., Wada, T., Handa, H., and Iba, H. (1997). Phosphorylation and high level expression of Fra-2 in v-src transformed cells: a pathway of activation of endogenous AP-1. *Oncogene* 14, 2435-2444.

Murakami, M., Ui, M., and Iba, H. (1999). Fra-2-positive autoregulatory loop triggered by mitogen-activated protein kinase (MAPK) and Fra-2 phosphorylation sites by MAPK. *Cell growth & differentiation : the molecular biology journal of the American Association for Cancer Research* 10, 333-342.

Muskiewicz, K.R., Frank, N.Y., Flint, A.F., and Gussoni, E. (2005). Myogenic potential of muscle side and main population cells after intravenous injection into sublethally irradiated mdx mice. *The journal of histochemistry and cytochemistry : official journal of the Histochemistry Society* 53, 861-873.

Myer, A., Olson, E.N., and Klein, W.H. (2001). MyoD cannot compensate for the absence of myogenin during skeletal muscle differentiation in murine embryonic stem cells. *Developmental biology* 229, 340-350.

Myer, A., Wagner, D.S., Vivian, J.L., Olson, E.N., and Klein, W.H. (1997). Wild-type myoblasts rescue the ability of myogenin-null myoblasts to fuse in vivo. *Developmental biology* 185, 127-138.

Naito, J., Kaji, H., Sowa, H., Hendy, G.N., Sugimoto, T., and Chihara, K. (2005). Menin suppresses osteoblast differentiation by antagonizing the AP-1 factor, JunD. *The Journal of biological chemistry* 280, 4785-4791.

Naya, F.J., and Olson, E. (1999). MEF2: a transcriptional target for signaling pathways controlling skeletal muscle growth and differentiation. *Curr Opin Cell Biol* 11, 683-688.

Neuhold, L.A., and Wold, B. (1993). HLH forced dimers: tethering MyoD to E47 generates a dominant positive myogenic factor insulated from negative regulation by Id. *Cell* 74, 1033-1042.

Nishikawa, J., Sakuma, K., Sorimachi, Y., Yoshimoto, K., and Yasuhara, M. (2005). Increase of Cardiotrophin-1 immunoreactivity in regenerating and overloaded but not denervated muscles of rats. *Neuropathology : official journal of the Japanese Society of Neuropathology* 25, 54-65.

Nishina, H., Sato, H., Suzuki, T., Sato, M., and Iba, H. (1990). Isolation and characterization of fra-2, an additional member of the fos gene family. *Proceedings of the National Academy of Sciences of the United States of America* 87, 3619-3623.

Norman, C., Runswick, M., Pollock, R., and Treisman, R. (1988). Isolation and properties of cDNA clones encoding SRF, a transcription factor that binds to the c-fos serum response element. *Cell* 55, 989-1003.

Novitch, B.G., Spicer, D.B., Kim, P.S., Cheung, W.L., and Lassar, A.B. (1999). pRb is required for MEF2-dependent gene expression as well as cell-cycle arrest during skeletal muscle differentiation. *Curr Biol* 9, 449-459.

Okazaki, S., Ito, T., Ui, M., Watanabe, T., Yoshimatsu, K., and Iba, H. (1998). Two proteins translated by alternative usage of initiation codons in mRNA encoding a JunD transcriptional regulator. *Biochemical and biophysical research communications* 250, 347-353.

Olguin, H.C., Yang, Z., Tapscott, S.J., and Olwin, B.B. (2007). Reciprocal inhibition between Pax7 and muscle regulatory factors modulates myogenic cell fate determination. *The Journal of cell biology* 177, 769-779.

Olson, E.N., Perry, M., and Schulz, R.A. (1995). Regulation of muscle differentiation by the MEF2 family of MADS box transcription factors. *Developmental biology* *172*, 2-14.

Olson, E.N., Sternberg, E., Hu, J.S., Spizz, G., and Wilcox, C. (1986). Regulation of myogenic differentiation by type beta transforming growth factor. *The Journal of cell biology* *103*, 1799-1805.

Olwin, B.B., and Hauschka, S.D. (1988). Cell surface fibroblast growth factor and epidermal growth factor receptors are permanently lost during skeletal muscle terminal differentiation in culture. *The Journal of cell biology* *107*, 761-769.

Oppenheim, R.W., Wiese, S., Prevette, D., Armanini, M., Wang, S., Houenou, L.J., Holtmann, B., Gotz, R., Pennica, D., and Sendtner, M. (2001). Cardiotrophin-1, a muscle-derived cytokine, is required for the survival of subpopulations of developing motoneurons. *The Journal of neuroscience : the official journal of the Society for Neuroscience* *21*, 1283-1291.

Ornatsky, O.I., Andreucci, J.J., and McDermott, J.C. (1997). A dominant-negative form of transcription factor MEF2 inhibits myogenesis. *J Biol Chem* *272*, 33271-33278.

Ostrovsky, O., Bengal, E., and Aronheim, A. (2002). Induction of terminal differentiation by the c-Jun dimerization protein JDP2 in C2 myoblasts and rhabdomyosarcoma cells. *The Journal of biological chemistry* *277*, 40043-40054.

Otto, A., Schmidt, C., Luke, G., Allen, S., Valasek, P., Muntoni, F., Lawrence-Watt, D., and Patel, K. (2008). Canonical Wnt signalling induces satellite-cell proliferation during adult skeletal muscle regeneration. *Journal of cell science* *121*, 2939-2950.

Page, J.L., Wang, X., Sordillo, L.M., and Johnson, S.E. (2004). MEKK1 signaling through p38 leads to transcriptional inactivation of E47 and repression of skeletal myogenesis. *J Biol Chem* *279*, 30966-30972.

Palacios, D., Mozzetta, C., Consalvi, S., Caretti, G., Saccone, V., Proserpio, V., Marquez, V.E., Valente, S., Mai, A., Forcales, S.V., *et al.* (2010). TNF/p38alpha/polycomb signaling to Pax7 locus in satellite cells links inflammation to the epigenetic control of muscle regeneration. *Cell stem cell* *7*, 455-469.

- Pannerec, A., Formicola, L., Besson, V., Marazzi, G., and Sassoon, D.A. (2013). Defining skeletal muscle resident progenitors and their cell fate potentials. *Development* *140*, 2879-2891.
- Pansters, N.A., van der Velden, J.L., Kelders, M.C., Laeremans, H., Schols, A.M., and Langen, R.C. (2011). Segregation of myoblast fusion and muscle-specific gene expression by distinct ligand-dependent inactivation of GSK-3beta. *Cellular and molecular life sciences : CMLS* *68*, 523-535.
- Parker, M.H., Perry, R.L., Fauteux, M.C., Berkes, C.A., and Rudnicki, M.A. (2006). MyoD synergizes with the E-protein HEB beta to induce myogenic differentiation. *Molecular and cellular biology* *26*, 5771-5783.
- Passegue, E., Jochum, W., Behrens, A., Ricci, R., and Wagner, E.F. (2002). JunB can substitute for Jun in mouse development and cell proliferation. *Nature genetics* *30*, 158-166.
- Passegue, E., and Wagner, E.F. (2000). JunB suppresses cell proliferation by transcriptional activation of p16(INK4a) expression. *The EMBO journal* *19*, 2969-2979.
- Pasut, A., Jones, A.E., and Rudnicki, M.A. (2013). Isolation and culture of individual myofibers and their satellite cells from adult skeletal muscle. *Journal of visualized experiments : JoVE*, e50074.
- Paxton, C.W., Cosgrove, R.A., Drozd, A.C., Wiggins, E.L., Woodhouse, S., Watson, R.A., Spence, H.J., Ozanne, B.W., and Pell, J.M. (2011). BTB-Kelch protein Krp1 regulates proliferation and differentiation of myoblasts. *Am J Physiol Cell Physiol* *300*, C1345-1355.
- Pedranzini, L., Dechow, T., Berishaj, M., Comenzo, R., Zhou, P., Azare, J., Bornmann, W., and Bromberg, J. (2006). Pyridone 6, a pan-Janus-activated kinase inhibitor, induces growth inhibition of multiple myeloma cells. *Cancer research* *66*, 9714-9721.
- Pedraza-Alva, G., Zingg, J.M., and Jost, J.P. (1994). AP-1 binds to a putative cAMP response element of the MyoD1 promoter and negatively modulates MyoD1 expression in dividing myoblasts. *J Biol Chem* *269*, 6978-6985.



- Penn, B.H., Bergstrom, D.A., Dilworth, F.J., Bengal, E., and Tapscott, S.J. (2004). A MyoD-generated feed-forward circuit temporally patterns gene expression during skeletal muscle differentiation. *Genes & development* 18, 2348-2353.
- Pennica, D., King, K.L., Shaw, K.J., Luis, E., Rullamas, J., Luoh, S.M., Darbonne, W.C., Knutzon, D.S., Yen, R., Chien, K.R., *et al.* (1995). Expression cloning of cardiotrophin 1, a cytokine that induces cardiac myocyte hypertrophy. *Proceedings of the National Academy of Sciences of the United States of America* 92, 1142-1146.
- Pennica, D., Swanson, T.A., Shaw, K.J., Kuang, W.J., Gray, C.L., Beatty, B.G., and Wood, W.I. (1996). Human cardiotrophin-1: protein and gene structure, biological and binding activities, and chromosomal localization. *Cytokine* 8, 183-189.
- Perry, R.L., Parker, M.H., and Rudnicki, M.A. (2001). Activated MEK1 binds the nuclear MyoD transcriptional complex to repress transactivation. *Mol Cell* 8, 291-301.
- Perry, R.L., and Rudnick, M.A. (2000). Molecular mechanisms regulating myogenic determination and differentiation. *Front Biosci* 5, D750-767.
- Peters, M., Roeb, E., Pennica, D., Meyer zum Buschenfelde, K.H., and Rose-John, S. (1995). A new hepatocyte stimulating factor: cardiotrophin-1 (CT-1). *FEBS letters* 372, 177-180.
- Pfarr, C.M., Mehta, F., Spyrou, G., Lallemand, D., Carillo, S., and Yaniv, M. (1994). Mouse JunD negatively regulates fibroblast growth and antagonizes transformation by ras. *Cell* 76, 747-760.
- Poleskaya, A., Naguibneva, I., Duquet, A., Bengal, E., Robin, P., and Harel-Bellan, A. (2001). Interaction between acetylated MyoD and the bromodomain of CBP and/or p300. *Molecular and cellular biology* 21, 5312-5320.
- Pownall, M.E., Gustafsson, M.K., and Emerson, C.P., Jr. (2002). Myogenic regulatory factors and the specification of muscle progenitors in vertebrate embryos. *Annu Rev Cell Dev Biol* 18, 747-783.
- Pradervand, S., Yasukawa, H., Muller, O.G., Kjekshus, H., Nakamura, T., St Amand, T.R., Yajima, T., Matsumura, K., Duplain, H., Iwatate, M., *et al.* (2004). Small proline-rich protein 1A is a gp130 pathway- and stress-inducible cardioprotective protein. *The EMBO journal* 23, 4517-4525.

Puri, P.L., Iezzi, S., Stiegler, P., Chen, T.T., Schiltz, R.L., Muscat, G.E., Giordano, A., Kedes, L., Wang, J.Y., and Sartorelli, V. (2001). Class I histone deacetylases sequentially interact with MyoD and pRb during skeletal myogenesis. *Mol Cell* 8, 885-897.

Puri, P.L., and Sartorelli, V. (2000). Regulation of muscle regulatory factors by DNA-binding, interacting proteins, and post-transcriptional modifications. *Journal of cellular physiology* 185, 155-173.

Puri, P.L., Sartorelli, V., Yang, X.J., Hamamori, Y., Ogryzko, V.V., Howard, B.H., Kedes, L., Wang, J.Y., Graessmann, A., Nakatani, Y., *et al.* (1997). Differential roles of p300 and PCAF acetyltransferases in muscle differentiation. *Mol Cell* 1, 35-45.

Qin, W., Khuchua, Z., Cheng, J., Boero, J., Payne, R.M., and Strauss, A.W. (1998). Molecular characterization of the creatine kinases and some historical perspectives. *Mol Cell Biochem* 184, 153-167.

Ramocki, M.B., Johnson, S.E., White, M.A., Ashendel, C.L., Konieczny, S.F., and Taparowsky, E.J. (1997). Signaling through mitogen-activated protein kinase and Rac/Rho does not duplicate the effects of activated Ras on skeletal myogenesis. *Molecular and cellular biology* 17, 3547-3555.

Rao, S.S., Chu, C., and Kohtz, D.S. (1994). Ectopic expression of cyclin D1 prevents activation of gene transcription by myogenic basic helix-loop-helix regulators. *Molecular and cellular biology* 14, 5259-5267.

Rawls, A., Morris, J.H., Rudnicki, M., Braun, T., Arnold, H.H., Klein, W.H., and Olson, E.N. (1995). Myogenin's functions do not overlap with those of MyoD or Myf-5 during mouse embryogenesis. *Developmental biology* 172, 37-50.

Reshef, R., Maroto, M., and Lassar, A.B. (1998). Regulation of dorsal somitic cell fates: BMPs and Noggin control the timing and pattern of myogenic regulator expression. *Genes & development* 12, 290-303.

Reynaud, E.G., Leibovitch, M.P., Tintignac, L.A., Pospel, K., Guillier, M., and Leibovitch, S.A. (2000). Stabilization of MyoD by direct binding to p57(Kip2). *J Biol Chem* 275, 18767-18776.

Reznik, M. (1969). Thymidine-3H uptake by satellite cells of regenerating skeletal muscle. *The Journal of cell biology* 40, 568-571.

Richards, C.D., Langdon, C., Pennica, D., and Gauldie, J. (1996). Murine cardiotrophin-1 stimulates the acute-phase response in rat hepatocytes and H35 hepatoma cells. *Journal of interferon & cytokine research : the official journal of the International Society for Interferon and Cytokine Research* 16, 69-75.

Ridgeway, A.G., Petropoulos, H., Wilton, S., and Skerjanc, I.S. (2000). Wnt signaling regulates the function of MyoD and myogenin. *J Biol Chem* 275, 32398-32405.

Rittling, S.R., Coutinho, L., Amram, T., and Kolbe, M. (1989). AP-1/jun binding sites mediate serum inducibility of the human vimentin promoter. *Nucleic acids research* 17, 1619-1633.

Robledo, O., Fourcin, M., Chevalier, S., Guillet, C., Auguste, P., Pouplard-Barthelaix, A., Pennica, D., and Gascan, H. (1997). Signaling of the cardiotrophin-1 receptor. Evidence for a third receptor component. *The Journal of biological chemistry* 272, 4855-4863.

Rommel, C., Clarke, B.A., Zimmermann, S., Nunez, L., Rossman, R., Reid, K., Moelling, K., Yancopoulos, G.D., and Glass, D.J. (1999). Differentiation stage-specific inhibition of the Raf-MEK-ERK pathway by Akt. *Science* 286, 1738-1741.

Roschger, P., Matsuo, K., Misof, B.M., Tesch, W., Jochum, W., Wagner, E.F., Fratzl, P., and Klaushofer, K. (2004). Normal mineralization and nanostructure of sclerotic bone in mice overexpressing Fra-1. *Bone* 34, 776-782.

Rosenblatt, J.D., Lunt, A.I., Parry, D.J., and Partridge, T.A. (1995). Culturing satellite cells from living single muscle fiber explants. *In vitro cellular & developmental biology Animal* 31, 773-779.

Roux, P.P., and Blenis, J. (2004). ERK and p38 MAPK-activated protein kinases: a family of protein kinases with diverse biological functions. *Microbiology and molecular biology reviews : MMBR* 68, 320-344.

Rudnicki, M.A., and Jaenisch, R. (1995). The MyoD family of transcription factors and skeletal myogenesis. *Bioessays* 17, 203-209.

- Ryseck, R.P., and Bravo, R. (1991). c-JUN, JUN B, and JUN D differ in their binding affinities to AP-1 and CRE consensus sequences: effect of FOS proteins. *Oncogene* 6, 533-542.
- Sabourin, L.A., Girgis-Gabardo, A., Seale, P., Asakura, A., and Rudnicki, M.A. (1999). Reduced differentiation potential of primary MyoD<sup>-/-</sup> myogenic cells derived from adult skeletal muscle. *The Journal of cell biology* 144, 631-643.
- Sarbasov, D.D., Jones, L.G., and Peterson, C.A. (1997). Extracellular signal-regulated kinase-1 and -2 respond differently to mitogenic and differentiative signaling pathways in myoblasts. *Mol Endocrinol* 11, 2038-2047.
- Schienda, J., Engleka, K.A., Jun, S., Hansen, M.S., Epstein, J.A., Tabin, C.J., Kunkel, L.M., and Kardon, G. (2006). Somitic origin of limb muscle satellite and side population cells. *Proceedings of the National Academy of Sciences of the United States of America* 103, 945-950.
- Schorpp-Kistner, M., Wang, Z.Q., Angel, P., and Wagner, E.F. (1999). JunB is essential for mammalian placentation. *The EMBO journal* 18, 934-948.
- Schreiber, M., Kolbus, A., Piu, F., Szabowski, A., Mohle-Steinlein, U., Tian, J., Karin, M., Angel, P., and Wagner, E.F. (1999). Control of cell cycle progression by c-Jun is p53 dependent. *Genes & development* 13, 607-619.
- Schreiber, M., Wang, Z.Q., Jochum, W., Fetka, I., Elliott, C., and Wagner, E.F. (2000). Placental vascularisation requires the AP-1 component fra1. *Development* 127, 4937-4948.
- Schutte, J., Viallet, J., Nau, M., Segal, S., Fedorko, J., and Minna, J. (1989). jun-B inhibits and c-fos stimulates the transforming and trans-activating activities of c-jun. *Cell* 59, 987-997.
- Seale, P., Sabourin, L.A., Girgis-Gabardo, A., Mansouri, A., Gruss, P., and Rudnicki, M.A. (2000). Pax7 is required for the specification of myogenic satellite cells. *Cell* 102, 777-786.
- Semsarian, C., Wu, M.J., Ju, Y.K., Marciniak, T., Yeoh, T., Allen, D.G., Harvey, R.P., and Graham, R.M. (1999). Skeletal muscle hypertrophy is mediated by a Ca<sup>2+</sup>-dependent calcineurin signalling pathway. *Nature* 400, 576-581.

Serra, C., Palacios, D., Mozzetta, C., Forcales, S.V., Morantte, I., Ripani, M., Jones, D.R., Du, K., Jhala, U.S., Simone, C., *et al.* (2007). Functional interdependence at the chromatin level between the MKK6/p38 and IGF1/PI3K/AKT pathways during muscle differentiation. *Mol Cell* 28, 200-213.

Serrano, A.L., Baeza-Raja, B., Perdiguero, E., Jardí, M., and Muñoz-Canoves, P. (2008). Interleukin-6 is an essential regulator of satellite cell-mediated skeletal muscle hypertrophy. *Cell metabolism* 7, 33-44.

Shaulian, E., and Karin, M. (2001). AP-1 in cell proliferation and survival. *Oncogene* 20, 2390-2400.

Shaulian, E., and Karin, M. (2002). AP-1 as a regulator of cell life and death. *Nature cell biology* 4, E131-136.

Sheng, Z., Knowlton, K., Chen, J., Hoshijima, M., Brown, J.H., and Chien, K.R. (1997). Cardiotrophin 1 (CT-1) inhibition of cardiac myocyte apoptosis via a mitogen-activated protein kinase-dependent pathway. Divergence from downstream CT-1 signals for myocardial cell hypertrophy. *The Journal of biological chemistry* 272, 5783-5791.

Sheng, Z., Pennica, D., Wood, W.I., and Chien, K.R. (1996). Cardiotrophin-1 displays early expression in the murine heart tube and promotes cardiac myocyte survival. *Development* 122, 419-428.

Shinin, V., Gayraud-Morel, B., Gomes, D., and Tajbakhsh, S. (2006). Asymmetric division and cosegregation of template DNA strands in adult muscle satellite cells. *Nature cell biology* 8, 677-687.

Simone, C., Stiegler, P., Bagella, L., Pucci, B., Bellan, C., De Falco, G., De Luca, A., Guanti, G., Puri, P.L., and Giordano, A. (2002). Activation of MyoD-dependent transcription by cdk9/cyclin T2. *Oncogene* 21, 4137-4148.

Smeal, T., Angel, P., Meek, J., and Karin, M. (1989). Different requirements for formation of Jun: Jun and Jun: Fos complexes. *Genes & development* 3, 2091-2100.

Smith, C.W., Klaasmeyer, J.G., Edeal, J.B., Woods, T.L., and Jones, S.J. (1999). Effects of serum deprivation, insulin and dexamethasone on polysome percentages in C2C12 myoblasts and differentiating myoblasts. *Tissue Cell* 31, 451-458.

- Sommer, H., Beltran, J.P., Huijser, P., Pape, H., Lonng, W.E., Saedler, H., and Schwarz-Sommer, Z. (1990). Deficiens, a homeotic gene involved in the control of flower morphogenesis in *Antirrhinum majus*: the protein shows homology to transcription factors. *The EMBO journal* *9*, 605-613.
- Sonobe, M.H., Yoshida, T., Murakami, M., Kameda, T., and Iba, H. (1995). fra-2 promoter can respond to serum-stimulation through AP-1 complexes. *Oncogene* *10*, 689-696.
- Spicer, D.B., Rhee, J., Cheung, W.L., and Lassar, A.B. (1996). Inhibition of myogenic bHLH and MEF2 transcription factors by the bHLH protein Twist. *Science* *272*, 1476-1480.
- Spizz, G., Roman, D., Strauss, A., and Olson, E.N. (1986). Serum and fibroblast growth factor inhibit myogenic differentiation through a mechanism dependent on protein synthesis and independent of cell proliferation. *J Biol Chem* *261*, 9483-9488.
- Stuelsatz, P., Pouzoulet, F., Lamarre, Y., Dargelos, E., Poussard, S., Leibovitch, S., Cottin, P., and Veschambre, P. (2010). Down-regulation of MyoD by calpain 3 promotes generation of reserve cells in C2C12 myoblasts. *J Biol Chem* *285*, 12670-12683.
- Sun, D., Li, H., and Zolkiewska, A. (2008). The role of Delta-like 1 shedding in muscle cell self-renewal and differentiation. *J Cell Sci* *121*, 3815-3823.
- Sun, L., Ma, K., Wang, H., Xiao, F., Gao, Y., Zhang, W., Wang, K., Gao, X., Ip, N., and Wu, Z. (2007). JAK1-STAT1-STAT3, a key pathway promoting proliferation and preventing premature differentiation of myoblasts. *The Journal of cell biology* *179*, 129-138.
- Taga, T., and Kishimoto, T. (1995). Signaling mechanisms through cytokine receptors that share signal transducing receptor components. *Current opinion in immunology* *7*, 17-23.
- Tajbakhsh, S., Borello, U., Vivarelli, E., Kelly, R., Papkoff, J., Duprez, D., Buckingham, M., and Cossu, G. (1998). Differential activation of Myf5 and MyoD by different Wnts in explants of mouse paraxial mesoderm and the later activation of myogenesis in the absence of Myf5. *Development* *125*, 4155-4162.

Tapscott, S.J. (2005). The circuitry of a master switch: MyoD and the regulation of skeletal muscle gene transcription. *Development* 132, 2685-2695.

Tapscott, S.J., Davis, R.L., Lassar, A.B., and Weintraub, H. (1990). MyoD: a regulatory gene of skeletal myogenesis. *Adv Exp Med Biol* 280, 3-5; discussion 5-6.

Tapscott, S.J., and Weintraub, H. (1991). MyoD and the regulation of myogenesis by helix-loop-helix proteins. *J Clin Invest* 87, 1133-1138.

Templeton, T.J., and Hauschka, S.D. (1992). FGF-mediated aspects of skeletal muscle growth and differentiation are controlled by a high affinity receptor, FGFR1. *Developmental biology* 154, 169-181.

Thepot, D., Weitzman, J.B., Barra, J., Segretain, D., Stinnakre, M.G., Babinet, C., and Yaniv, M. (2000). Targeted disruption of the murine junD gene results in multiple defects in male reproductive function. *Development* 127, 143-153.

Thinakaran, G., Ojala, J., and Bag, J. (1993). Expression of c-jun/AP-1 during myogenic differentiation in mouse C2C12 myoblasts. *FEBS letters* 319, 271-276.

Thompson, J.E., Cubbon, R.M., Cummings, R.T., Wicker, L.S., Frankshun, R., Cunningham, B.R., Cameron, P.M., Meinke, P.T., Liverton, N., Weng, Y., *et al.* (2002). Photochemical preparation of a pyridone containing tetracycline: a Jak protein kinase inhibitor. *Bioorganic & medicinal chemistry letters* 12, 1219-1223.

Tian, Z.J., Cui, W., Li, Y.J., Hao, Y.M., Du, J., Liu, F., Zhang, H., Zu, X.G., Liu, S.Y., Chen, L., *et al.* (2004). Different contributions of STAT3, ERK1/2, and PI3-K signaling to cardiomyocyte hypertrophy by cardiotrophin-1. *Acta pharmacologica Sinica* 25, 1157-1164.

Tonin, P.N., Scrabble, H., Shimada, H., and Cavenee, W.K. (1991). Muscle-specific gene expression in rhabdomyosarcomas and stages of human fetal skeletal muscle development. *Cancer Res* 51, 5100-5106.

Trouche, D., Grigoriev, M., Lenormand, J.L., Robin, P., Leibovitch, S.A., Sassone-Corsi, P., and Harel-Bellan, A. (1993). Repression of c-fos promoter by MyoD on muscle cell differentiation. *Nature* 363, 79-82.

- Tsakiridis, T., Taha, C., Grinstein, S., and Klip, A. (1996). Insulin activates a p21-activated kinase in muscle cells via phosphatidylinositol 3-kinase. *J Biol Chem* *271*, 19664-19667.
- Uezumi, A., Ojima, K., Fukada, S., Ikemoto, M., Masuda, S., Miyagoe-Suzuki, Y., and Takeda, S. (2006). Functional heterogeneity of side population cells in skeletal muscle. *Biochemical and biophysical research communications* *341*, 864-873.
- van Straaten, F., Muller, R., Curran, T., Van Beveren, C., and Verma, I.M. (1983). Complete nucleotide sequence of a human c-onc gene: deduced amino acid sequence of the human c-fos protein. *Proceedings of the National Academy of Sciences of the United States of America* *80*, 3183-3187.
- Vandel, L., Montreau, N., Vial, E., Pfarr, C.M., Binetruy, B., and Castellazzi, M. (1996). Stepwise transformation of rat embryo fibroblasts: c-Jun, JunB, or JunD can cooperate with Ras for focus formation, but a c-Jun-containing heterodimer is required for immortalization. *Molecular and cellular biology* *16*, 1881-1888.
- Vogt, P.K., Bos, T.J., and Doolittle, R.F. (1987). Homology between the DNA-binding domain of the GCN4 regulatory protein of yeast and the carboxyl-terminal region of a protein coded for by the oncogene jun. *Proceedings of the National Academy of Sciences of the United States of America* *84*, 3316-3319.
- von Maltzahn, J., Bentzinger, C.F., and Rudnicki, M.A. (2012). Wnt7a-Fzd7 signalling directly activates the Akt/mTOR anabolic growth pathway in skeletal muscle. *Nature cell biology* *14*, 186-191.
- Wagner, J., Schmidt, C., Nikowits, W., Jr., and Christ, B. (2000). Compartmentalization of the somite and myogenesis in chick embryos are influenced by wnt expression. *Developmental biology* *228*, 86-94.
- Walsh, K., and Gualberto, A. (1992). MyoD binds to the guanine tetrad nucleic acid structure. *J Biol Chem* *267*, 13714-13718.
- Wang, D.Z., Valdez, M.R., McAnally, J., Richardson, J., and Olson, E.N. (2001). The Mef2c gene is a direct transcriptional target of myogenic bHLH and MEF2 proteins during skeletal muscle development. *Development* *128*, 4623-4633.



Wang, K., Wang, C., Xiao, F., Wang, H., and Wu, Z. (2008). JAK2/STAT2/STAT3 are required for myogenic differentiation. *The Journal of biological chemistry* 283, 34029-34036.

Wang, Z.Q., Ovitt, C., Grigoriadis, A.E., Mohle-Steinlein, U., Ruther, U., and Wagner, E.F. (1992). Bone and haematopoietic defects in mice lacking c-fos. *Nature* 360, 741-745.

Wen, Z., Zhong, Z., and Darnell, J.E., Jr. (1995). Maximal activation of transcription by Stat1 and Stat3 requires both tyrosine and serine phosphorylation. *Cell* 82, 241-250.

Whitmarsh, A.J., and Davis, R.J. (1996). Transcription factor AP-1 regulation by mitogen-activated protein kinase signal transduction pathways. *Journal of molecular medicine* 74, 589-607.

Williams, B.A., and Ordahl, C.P. (2000). Fate restriction in limb muscle precursor cells precedes high-level expression of MyoD family member genes. *Development* 127, 2523-2536.

Winter, B., and Arnold, H.H. (2000). Activated raf kinase inhibits muscle cell differentiation through a MEF2-dependent mechanism. *J Cell Sci* 113 Pt 23, 4211-4220.

Winter, B., Braun, T., and Arnold, H.H. (1993). cAMP-dependent protein kinase represses myogenic differentiation and the activity of the muscle-specific helix-loop-helix transcription factors Myf-5 and MyoD. *J Biol Chem* 268, 9869-9878.

Wisdon, R., and Verma, I.M. (1993). Transformation by Fos proteins requires a C-terminal transactivation domain. *Molecular and cellular biology* 13, 7429-7438.

Wright, W.E., Sassoon, D.A., and Lin, V.K. (1989). Myogenin, a factor regulating myogenesis, has a domain homologous to MyoD. *Cell* 56, 607-617.

Wu, Y., Zhang, X., Salmon, M., Lin, X., and Zehner, Z.E. (2007). TGFbeta1 regulation of vimentin gene expression during differentiation of the C2C12 skeletal myogenic cell line requires Smads, AP-1 and Sp1 family members. *Biochimica et biophysica acta* 1773, 427-439.

Xu, Q., and Wu, Z. (2000). The insulin-like growth factor-phosphatidylinositol 3-kinase-Akt signaling pathway regulates myogenin expression in normal myogenic cells but not in rhabdomyosarcoma-derived RD cells. *J Biol Chem* 275, 36750-36757.

Yaffe, D., and Saxel, O. (1977). Serial passaging and differentiation of myogenic cells isolated from dystrophic mouse muscle. *Nature* 270, 725-727.

Yang, W., Chen, Y., Zhang, Y., Wang, X., Yang, N., and Zhu, D. (2006). Extracellular signal-regulated kinase 1/2 mitogen-activated protein kinase pathway is involved in myostatin-regulated differentiation repression. *Cancer research* 66, 1320-1326.

Yanofsky, M.F., Ma, H., Bowman, J.L., Drews, G.N., Feldmann, K.A., and Meyerowitz, E.M. (1990). The protein encoded by the Arabidopsis homeotic gene *agamous* resembles transcription factors. *Nature* 346, 35-39.

Yazgan, O., and Pfarr, C.M. (2002). Regulation of two JunD isoforms by Jun N-terminal kinases. *The Journal of biological chemistry* 277, 29710-29718.

Yip-Schneider, M.T., Klein, P.J., Wentz, S.C., Zeni, A., Menze, A., and Schmidt, C.M. (2009). Resistance to mitogen-activated protein kinase kinase (MEK) inhibitors correlates with up-regulation of the MEK/extracellular signal-regulated kinase pathway in hepatocellular carcinoma cells. *The Journal of pharmacology and experimental therapeutics* 329, 1063-1070.

Yoshida, N., Yoshida, S., Koishi, K., Masuda, K., and Nabeshima, Y. (1998). Cell heterogeneity upon myogenic differentiation: down-regulation of MyoD and Myf-5 generates 'reserve cells'. *J Cell Sci* 111 ( Pt 6), 769-779.

Yoshida, T., Sato, H., and Iba, H. (1991). Transcription of fra-2 mRNA and phosphorylation of Fra-2 protein are stimulated by serum. *Biochemical and biophysical research communications* 174, 934-939.

Yu, C.L., Meyer, D.J., Campbell, G.S., Lerner, A.C., Carter-Su, C., Schwartz, J., and Jove, R. (1995). Enhanced DNA-binding activity of a Stat3-related protein in cells transformed by the Src oncoprotein. *Science* 269, 81-83.

Zammit, P.S., Golding, J.P., Nagata, Y., Hudon, V., Partridge, T.A., and Beauchamp, J.R. (2004). Muscle satellite cells adopt divergent fates: a mechanism for self-renewal? *The Journal of cell biology* 166, 347-357.

Zetser, A., Gredinger, E., and Bengal, E. (1999). p38 mitogen-activated protein kinase pathway promotes skeletal muscle differentiation. Participation of the Mef2c transcription factor. *J Biol Chem* 274, 5193-5200.

Zhang, W., Behringer, R.R., and Olson, E.N. (1995a). Inactivation of the myogenic bHLH gene MRF4 results in up-regulation of myogenin and rib anomalies. *Genes & development* 9, 1388-1399.

Zhang, X., Blenis, J., Li, H.C., Schindler, C., and Chen-Kiang, S. (1995b). Requirement of serine phosphorylation for formation of STAT-promoter complexes. *Science* 267, 1990-1994.

# Appendices

**Appendix A: Mustn1 as a novel AP-1 target gene in skeletal muscle cells**

Experimental design and drafting manuscript  
Nezeka S Alli and Dr. John C McDermott

Conducting experiments

Data provided by S. J. Tapscott (Cao et al., 2010) 1A, 1B, 1C, 1D

Nezeka S Alli; figure 1A, 1B, 1C, 2A, 2B, 3

## Summary

Satellite cells are the adult muscle stem cells and are marked by the expression of Pax7 and Myf5 transcription factors. Previously, the AP-1 subunit Fra-2 was shown to be co-expressed in Pax7 positive satellite cells of single primary muscle fibres indicating a possible role for AP-1 in muscle regeneration. The genes targeted by AP-1 in skeletal muscle regeneration are of interest but are currently unknown. In this study we demonstrate that Fra-2 regulates *mustn1*, a MyoD and AP-1 target gene expressed in skeletal muscle and satellite cells.

## Introduction

The events that comprise skeletal myogenesis are commitment, differentiation and regeneration. Skeletal myogenesis is regulated by the myogenic regulatory factors (MRFs), which are a family of skeletal muscle specific transcription factors (Molkentin and Olson, 1996b). The MRF are basic helix loop helix proteins that along with myocyte enhancer factor 2 (MEF2) transcription factors regulate gene expression required for in skeletal muscle development (Molkentin and Olson, 1996a; Pownall et al., 2002; Puri and Sartorelli, 2000). Myogenic cells are specified in mesodermal cells of the somites by Pax3 and Pax7 transcription factors. Pax3 and Pax7 regulate expression of Myf5 and MyoD which are commitment factors of myoblasts. MyoD along with MEF2 proteins regulate expression of muscle differentiation factors such as Myogenin and muscle creatine kinase (MCK) (Qin et al., 1998). Injured skeletal muscle fibres are capable of repairing as they possess adult muscle stem cells termed satellite cells (Bischoff, 1975). Satellite cells are located within the basal lamina and

scaroplasma of the fibre and express Myf5 and Pax7 (Kuang et al., 2007). Activated satellite cells proliferate and undergo differentiation or self-renewal. Satellite cells can self-renew in which case they express Pax7 or they can differentiate in which case they upregulate myogenic factors MyoD and Myogenin forming a cluster of clonogenic, myogenic cells that will form a new fibre or contribute to an existing one (Buckingham and Montarras, 2008).

Activator protein-1 (AP-1) is a transcription factor complex that is composed of Jun and Fos proteins that have implications for skeletal myogenesis. The Jun proteins include c-Jun, JunB and JunD and can homodimerize or heterodimerize with Fos proteins, c-Fos, FosB, Fra-1 and Fra-2 (Angel and Karin, 1991). AP-1 research has evolved since the early nineties following its discovery. Overall, AP-1 is a negative regulator of skeletal muscle differentiation suggested by the data in the literature to date (Alli et al., 2013; Bengal et al., 1992; Thinakaran et al., 1993). The transcription factor complex has defined roles in proliferation mediating the activation of cell cycle progression genes (Schreiber et al., 1999) and repression of myogenic factors, specifically MyoD (Bengal et al., 1992). The AP-1 proteins can also bind DNA in differentiating myoblast cells (Andreucci et al., 2002) but the muscle specific genes regulated remain largely unknown. More recently, a regenerative role for the AP-1 subunit Fra-2 has been proposed (Alli et al., 2013). Expression data suggests that AP-1 may have a role in regulating quiescence and activation of satellite cells (Alli et al., 2013). AP-1 already has been shown to activate proliferation in stem cells in other lineages (Biteau and Jasper, 2011; Kook et al., 2013) and may be a regulator of muscle stem cell function.

A less characterized AP-1 target gene in skeletal muscle is *mustn1*. *Mustn1* was originally identified in a bone fracture screen and has been reported to be regulated by AP-1 (Liu and Hadjiargyrou, 2006; Lombardo et al., 2004). Furthermore, AP-1 complexes were reported to activate a *mustn1* driven luciferase reporter (Liu and Hadjiargyrou, 2006). More recently, GFP expression when driven by the *mustn1* promoter was detected in Pax7 positive satellite cells in muscle fibres (Krause et al., 2013). These data suggest that *mustn1* may have a role in skeletal muscle regeneration and its regulation may be influenced by AP-1.

In this study, we evaluate a subset of MyoD target genes that are enriched for AP-1 binding sites. We show that one of these genes, *mustn1*, is expressed in skeletal muscle cells. We also demonstrate that the AP-1 subunit, Fra-2, targets the *mustn1* gene in skeletal muscle.

## **Materials and Methods**

**Cell culture.** The C2C12 cell line was purchased from American Tissue Culture Collection (ATCC). Cells were maintained in growth media (GM) consisting of 10% foetal calf serum (FBS) in Dulbecco modified eagles medium (DMEM) (Gibco) supplemented with 2mM L-glutamine and 100µg/ml penicillin/streptomycin (Invitrogen). Cells were induced to differentiate at 80% confluency using differentiation media (DM) consisting of 2% horse serum in DMEM supplemented with 2mM L-glutamine and 100µg/ml penicillin/streptomycin (Invitrogen).



**ChIP and qPCR.** Plates were washed once with 1X PBS (4°C) to remove media. Cells were incubated with 1% formaldehyde for 15 min at RT after which 0.125 M of glycine was added. Liquid was removed and cells were washed three times with 1X PBS (4°C). Cells were scraped in 1 ml of 1X PBS and protease and phosphatase inhibitors (4°C) and centrifuged for 5 min at 5000 rpm at 4°C to pellet cells. Supernatant were removed and cells resuspended with 1 ml of Wash buffer I (10mM HEPES pH 6.5, 0.5 mM EGTA, 10mM EDTA, 0.25% Triton X-100, protease and phosphatase inhibitors) and Incubated on ice for 5 min. Lysate was centrifuged for 5 min at 3000 rpm at 4°C, supernatant was removed and nuclei were resuspended in 1 ml of Wash buffer 2 (10mM, HEPES pH 6.5, 0.5mM EGTA, 1mM EDTA, 200mM NaCl, protease and phosphatase inhibitors) and incubate for 10 min on ice followed by centrifugation at 5000 rpm for 5 min at 4° and removal of supernatant. To lyse nuclei, 250 µl of SDS lysis buffer (50mM Tris-HCl ph 8.1, 1mM EDTA, 1% SDS, protease and phosphatase inhibitors, prepare fresh) was added to nuclei. DNA was sonicated to approximately 250-600 bp fragments. Samples were centrifuge at max speed for 15 min at 4°C to remove insoluble materials. Supernatant, containing sheared DNA, were transferred to a clean tube. Protein G dynal magnetic beads were blocked using salmon sperm DNA while 1µg of Fra-2 (SantaCruz Q-20) primary antibody was incubated with sheared DNA overnight at 4°C. Pre-blocked protein G dynal magnetic beads were added to the IP reaction and incubated for 1h at 4°C. The magnetic beads were washed with low salt wash buffer (20mM Tris pH 8.1, 2mM EDTA, 150mM NaCl, 1% Triton-X 100, 0.1% SDS) followed by washing in high salt buffer (20mM Tris pH 8.1, 2mM EDTA, 500mM NaCl, 1% Triton-X 100, 0.1% SDS. Beads were then washed twice with Tris-

EDTA. Protein-DNA complex were eluted from beads by incubating with elution buffer (0.1M NaHCO<sub>3</sub>, 1% SDS) for 30min at room temperature. Collect supernatant in clean tubes and incubate with 5M NaCl overnight at 65°C. Isolated DNA was purified using the Qiagen PCR clean up kit, as per manufactures instructions. Samples were analyzed using the Applied biosystems 7500 real time PCR system.

**qRT-PCR.** RNA was isolated from C2C12 cells using the RNeasy kit (Qiagen) following manufactures protocol. Isolated RNA was converted to cDNA using superscript II (Invitrogen) following manufactures protocol. Specific primers for *mustn1* were use to amplify the cDNA template. Samples were run on a 1.2% agarose gel containing ethidium bromide. Bands on the agarose gel were visualized using an imager.

## **Results and Discussion**

### ***The MyoD target Mustn1 contains AP-1 DNA binding sites***

Genes regulated by AP-1 in skeletal muscle differentiation and regeneration are largely unknown but large scale studies of MyoD ChIP-sequencing and MEF2 ChIP-exonuclease from our group (Stephanie Wales, unpublished observations) have revealed that their respective binding sites, CANNTG and AT rich sites such as 5'C/TTA(AT)<sub>4</sub>TAG/A', are enriched with 12-*O*-tetradecanolyphorbol 13-acetate (TPA) responsive elements (TRE's) (Angel et al., 1987; Lamph et al., 1988), which are identified by its 5' TGAC/GTCA 3' consensus sequence TRE's (Cao et al., 2010). These data support the hypothesis that AP-1 may also contribute to the control of

muscle specific gene expression in skeletal muscle. A genome wide MyoD ChIP-sequence performed in Stephen J. Tapscott's lab (Cao et al., 2010) analyzed MyoD binding in target promoters in myoblast and myotube cultures. The group also assessed changes in expression of these genes using an array study (Cao et al., 2010). Using a motif search it was predicted that many promoters (approximately 839) where MyoD binding occurred were also enriched for AP-1 sites (data provided by S.J. Tapscott, based on paper by Cao et al (Cao et al., 2010). Of the MyoD bound genes, 43% did not change in expression while 4% did have changes in expression during differentiation (figure 1A). A total of 35 genes that were enriched for AP-1 binding sites had changes in expression (figure 1B). Of the 35 genes 14 had increased expression and 21 had decreased expression during differentiation relative to proliferation (figure 1C). Further analysis was done and it was determined that 3 of the 35 genes contained AP-1 binding sites that were less than 2.0 kb from the transcriptional start, thus in the regulatory regions (figure 1C). These genes were *mustn1*, *F2r*, and *Tpbp* (figure 1C). Although, these genes have MyoD regulatory sites and AP-1 binding regions, only the *mustn1* genes was expressed in adult skeletal muscle (Lombardo et al., 2004) and has been reported to be required for MT fusion (Liu et al., 2010). The MyoD binding region is on the *mustn1* promoter shown in figure 1D. These data suggest that AP-1 may regulate a subset of MyoD target genes and could participate in an antagonistic role in their expression.

A

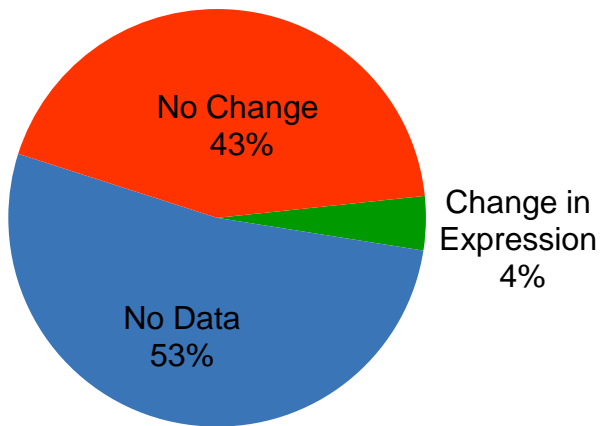

B

Pattern	Gene	Distance to TSS	Array fold change
TGACTCA	Pir	-25708	-5.594
TGACTCA	Dermo1	15286	-2.452
TGACTCA	Arl7	62629	-2.232
TGACTCA	Pdk4	66621	-2.022
TGACTCA	Pdk4	66621	-2.022
TGACTCA	Id1	-9370	-1.844
TGACTCA	Tsp2	34215	-1.659
TGACTCA	Osbp2	-7684	-1.651
TGACTCA	Acp1	-15318	-1.428
TGACTCA	Tpbp	-284	-1.426
TGACTCA	Abcc4	24946	-1.413
TGACTCA	Chc1	4005	-1.399
TGACTCA	Tuba6	985	-1.338
TGACTCA	Htra1	25259	-1.298
TGACTCA	Igfbp2	-40976	-1.275
TGACTCA	F2r	-164	-1.206
TGACTCA	Cis3	36790	-1.182
TGACTCA	O9CZ28	-9789	-1.172
TGACTCA	Vps37b	-20156	-1.125
TGACTCA	Ica1	-2318	-1.049
TGACTCA	Rbpm2	6483	-1.04
TGACTCA	Il33	-7575	1.044
TGACTCA	Il33	-7575	1.044
TGACTCA	Insiq1	-34103	1.15
TGACTCA	O3UR46	19367	1.453
TGACTCA	Il12a	-6835	1.478
TGACTCA	Vdu2	-2632	1.508
TGACTCA	Mustn1	-1522	1.573
TGACTCA	Kremen	-3836	1.596
TGACTCA	Baiap211	-14230	1.642
TGACTCA	Baiap211	73317	1.642
TGACTCA	Klhl30	1429	1.736
TGACTCA	Nrap	22081	1.744
TGACTCA	Mmp15	33907	2.518
TGACTCA	Dcn	34243	3.526

C

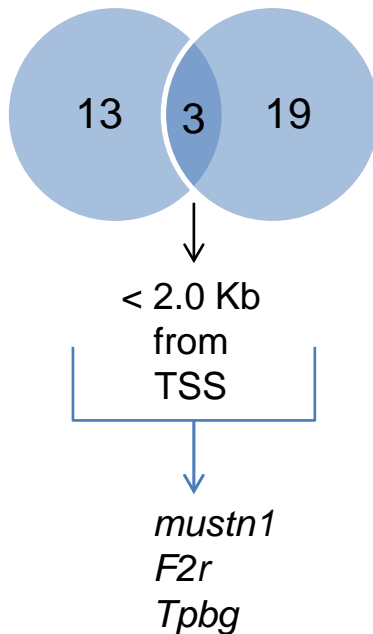

### Figure 1. MyoD ChIP data analysis of potential AP-1 target genes.

(A) Pie chart showing that 4% of genes that had changes in expression contained MyoD and AP-1 binding sites, while 43% of genes did not. There was no expression data for 53% of these genes. (B) List of genes and fold change in expression from proliferation to differentiation that contain MyoD and AP-1 binding sites. (C) Venn diagram showing 3 of the 35 genes with changes in expression had MyoD and AP-1 binding sites in regulator regions in their promoters.

D

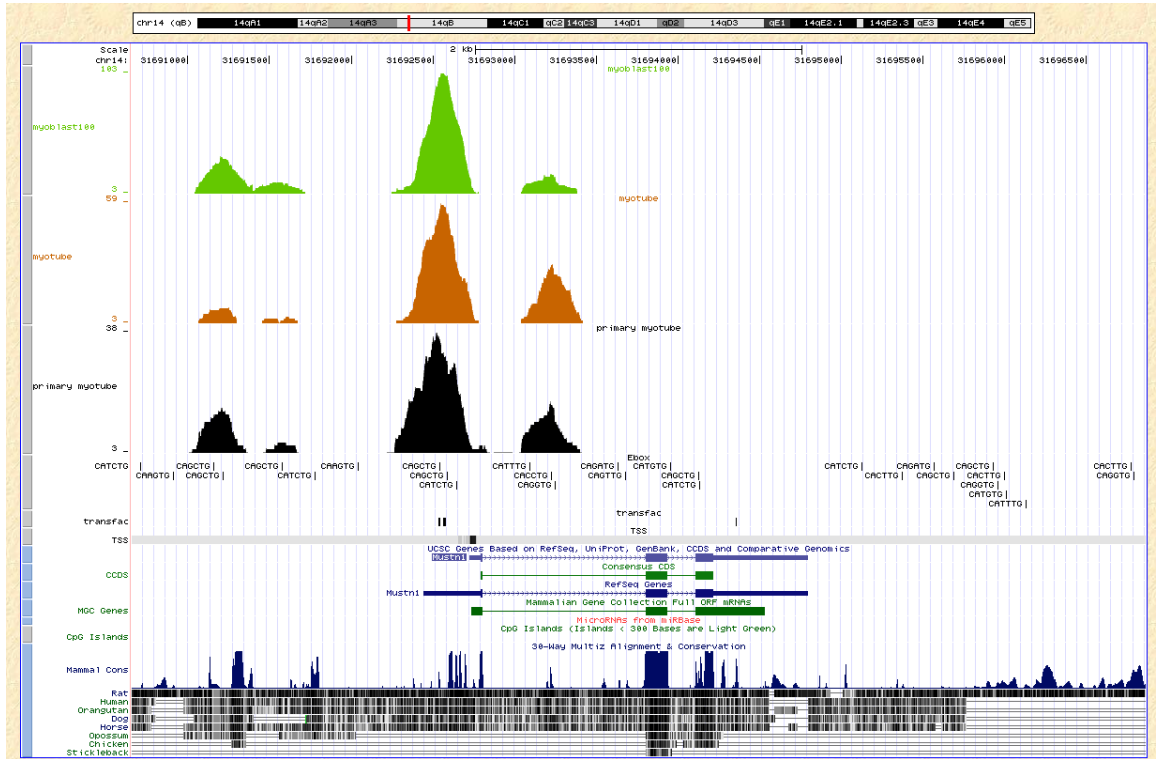
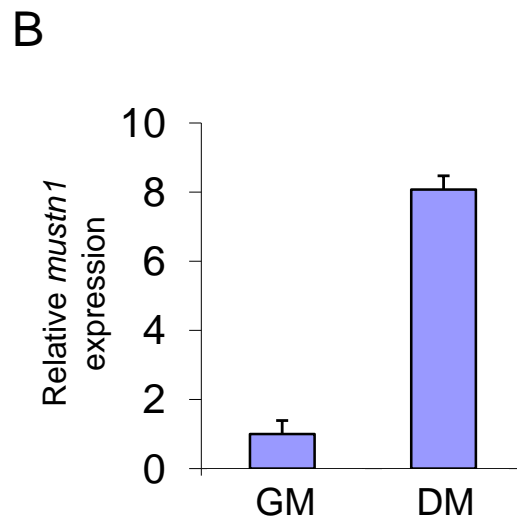
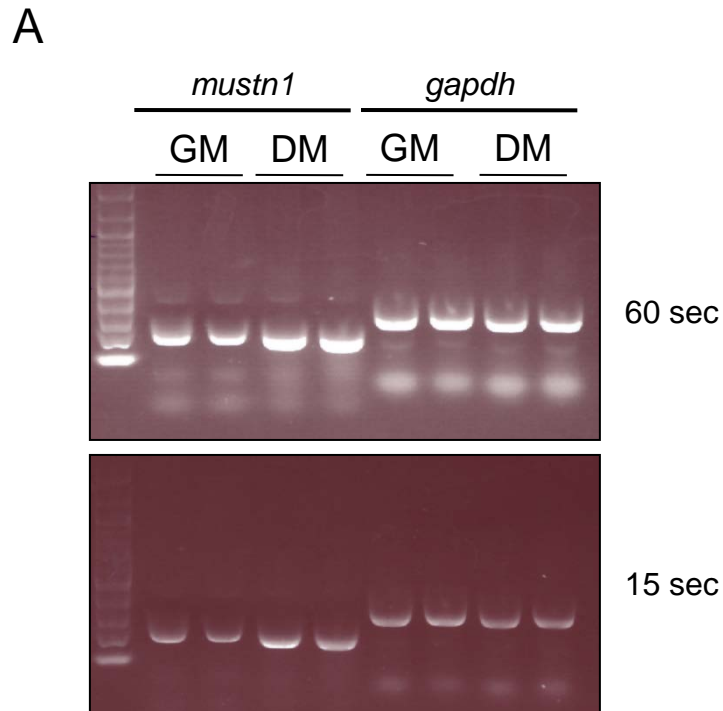

**Figure 1. MyoD ChIP data analysis of potential AP-1 target genes.**  
 (D) Screen shot from genome browser showing location of MyoD binding in the *mustn1* promoter.

### ***Mustn1 is expressed in skeletal muscle and satellite cells***

To determine if *mustn1* was expressed in the C2C12 cell line, a model for skeletal muscle differentiation we assessed its gene expression using RT-PCR. The *mustn1* transcript was detected in both proliferation (using GM) and differentiation (using DM) conditions (figure 2A). Interestingly, levels of *mustn1* seemed higher in differentiation conditions compared to proliferative conditions (figure 2A). Since RT-PCR is semi-quantitative, qRT-PCR was employed to determine if there were changes in levels of *mustn1* from proliferative to differentiation. Figure 2B shows that *mustn1* expression was 8-fold greater in differentiation versus proliferative. These results demonstrate that *mustn1* is expressed in C2C12 cells and that expression is higher under differentiating conditions.

However, recent expression data demonstrates that AP-1 is differentially expressed in a culture of differentiated C2C12 cells. A differentiated culture contains terminally differentiated MT and quiescent mononucleated cells and AP-1 proteins are exclusively expressed in mononucleated cells (Alli et al., 2013). Furthermore, Fra-2 expression was detected in satellite cells of primary single muscle fibres, not in the myocyte (Alli et al., 2013).

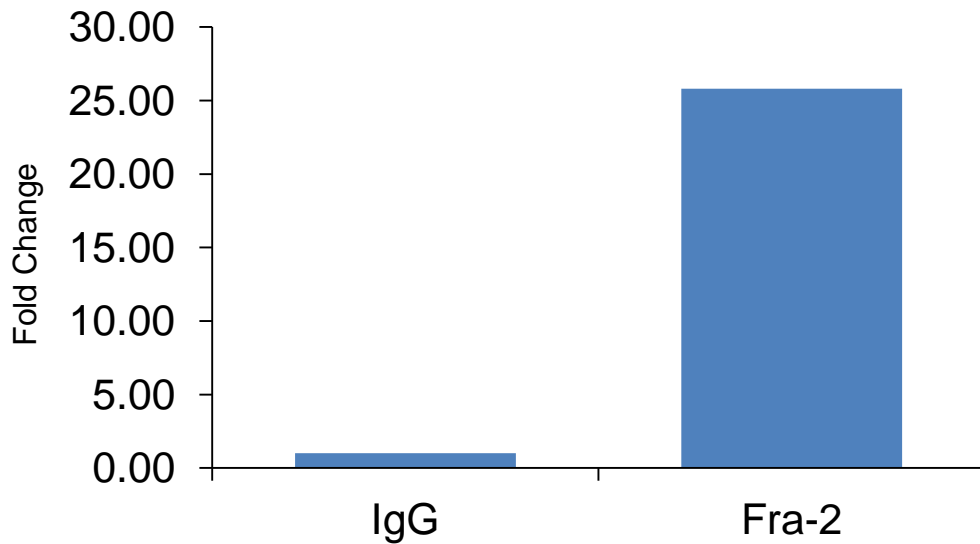

**Figure 2. *mustn1* expression is increased in differentiating skeletal muscle.** (A) RNA was isolated from C2C12 cells and RT-PCR of *mustn1* expression in growth (growth media; GM) and differentiation (differentiation media; DM) condition was performed. *Gapdh* was used as an internal control. The first panel is a 60 sec exposure of the agarose gel to ultra violet light and the second panel is a 15 sec exposure (B) RNA was isolated from C2C12 cells and qRT-PCR of *mustn1* expression in growth and differentiation condition was performed. GM and DM samples were analyzed in triplicate and are relative to *gapdh* expression.

***AP-1 and MyoD both bind to *mustn1****

Studies using luciferase assays have demonstrated that AP-1 transcription factors can regulate an exogenously expressed *mustn1* promoter (Liu and Hadjiargyrou, 2006). The *mustn1* promoter has multiple AP-1 sites but by using the *mustn1* promoter fused to luciferase the regulated site was determined (Liu and Hadjiargyrou, 2006). A Fra-2 ChIP was performed to further investigate AP-1 binding to the *mustn1* promoter. Using ChIP we observed direct binding Fra-2 to endogenous *mustn1* promoter in skeletal muscle (figure 3). Altogether, these preliminary, novel data implicate *mustn1* as a Fra-2 target gene in differentiating skeletal muscle and regeneration.





**Figure 3. Fra-2 binds to the endogenous *mustn1* promoter in skeletal muscle.**

Chromatin was isolated and sheared from C2C12 cells, 72h in differentiation conditions. Chromatin was immunoprecipitated using a Fra-2 antibody or rabbit IgG control. qPCR was performed on the isolated DNA fragments using *mustn1* specific primers flanking the AP-1 site. Samples immunoprecipitated with IgG or Fra-2 were analyzed in triplicate. Fold change was calculated relative to input samples.

## **Appendix B: Methods**

## **Appendix B: Methods**

### **Cell Culture**

#### **Reagents:**

DMEM (supplemented with 1% Penicillin-Streptomycin (Gibco) and 1% L-glutamine (Gibco) added as required)

1X Dulbecco's PBS

Versene (VE) (0.2g of EDTA in 1L 1X PBS),

0.125% trypsin in VE (Gibco)

Freezing medium ((Growth media (GM) supplemented with 10% DMSO); sterilize the freezing medium by passing through a 0.2um filter), FBS (heat inactivated at 56°C for 30 min), HS (heat inactivated at 56°C for 30 min).

1% gelatin for coating plates

#### *Cell passaging*

1. Aspirate media.
2. Rinse cells with 5 ml of VE.
3. Remove VE and add 1 ml of 0.125% trypsin solution.
4. Pipette the trypsin solution.
5. Using a light microscope check if cells are detaching
6. Add 10 ml of GM and resuspend cells
7. Plate cells accordingly.

#### *Inducing Muscle Cell Differentiation*

1. At approximately 80% confluence, wash cells twice with 1X PBS
2. Add 10 ml of DM.
3. Change media to new DM every 48h

## **Transfection**

### *Calcium chloride mediated transfection of mammalian cells*

#### **Reagents:**

2x HEBS (2.8 M NaCl, 15mM Na<sub>2</sub>HPO<sub>4</sub>, 50mM HEPESpH to 7.15, filter sterilize)

2.5 M CaCl<sub>2</sub> (filter sterilize)

#### **Calcium-phosphate transfection**

1. Plate cells one day before transfection for 30-50% confluent ( $1.0 \times 10^5$  cells/ml for 100 mm plates and  $12.5 \times 10^3$  cells/ml for 6 well plates).
2. Change to fresh GM 3 h prior to transfecting.
3. Add 500 $\mu$ l of 2X HEBS to a 10ml conical tube.
4. Prepare DNA-CaCl<sub>2</sub> solution as follows, add 25 $\mu$ g DNA and bring up to a final volume of 450 $\mu$ l with ddH<sub>2</sub>O. Mix.
5. Add 50 $\mu$ l of 2.5 M CaCl<sub>2</sub>. Mix.
6. Add DNA-CaCl<sub>2</sub> solution drop-wise to the 2X HEBS while gently vortexing
7. Add DNA mix drop-wise to plates while moving palate back and forth to mix.
8. Incubate cells with transfection mixture for 16h.
9. Wash cells twice with 1X PBS
10. Add 10ml of fresh GM.
11. Recover for at least 6-8h

### *Lipofectamine transfection for C2C12 cells*

See manufactures protocol for details

1. Prepare DNA-lipofectamine mixture.
2. Add a total of 5 $\mu$ g of DNA to 1 ml of DMEM (no antibiotic and serum for lipofectamine – Invitrogen) and 35  $\mu$ l of Lipofectamine reagent to 1ml of DMEM for 100mm plates. Use a total of 1 $\mu$ g of DNA and 7 $\mu$ l of lipofectamine/well for 6 well plates. Incubate for 5 min at RT
3. Add DNA mixture to lipofectamine mixture and incubate for 20-40 min at RT
4. During incubation wash cells twice with 1X PBS and add 4 ml of DMEM to plate
5. Add 2 ml of DMEM to DNA-lipofectamine mixture for a total of 4 ml and mix
6. Add DNA-lipofectamine mixture (4ml) drop wise to plate
7. Incubate cells with DNA-lipofectamine mixture for 5 h
8. Add 2 ml of FBS to plates to stop transfection or wash plates twice with 1X PBS and add 10 ml of 20% FBS in DMEM to plate
9. Recover O/N and harvest at desired time point.

### **Luciferase Assay**

**Reagents:** Luciferase assay Lysis buffer (20 mM Tris, pH 7.4, 0.1% Triton-X 100), Luciferase substrate (Promega), Renilla substrate (Promega)

1. Following transfection protocol and harvest using the following.
2. Wash adherent cells twice with 1XPBS (4°C).
3. Add 300µl of Luciferase lysis buffer per well (35mm)
4. Scrape cells in each well and collect in 1.5ml eppendorph tubes
5. Vortex cells in tube and spin 16.1 X 1000 G for 10min.
6. Transfer 20µl – 100µl of supernatant to Luciferase assay tube.
7. Read sample using a luminomitor that injects luciferase substrate
8. If using Renilla as an internal control. Add supernatant to another assay tube and using Renilla substrate read samples using liminomintor.

### **β-Galactosidase Assay**

**Reagents:** ONPG (4 mg/ml in ddH<sub>2</sub>O), Z buffer (60 mM Na<sub>2</sub>HPO<sub>4</sub>, 40mM NaH<sub>2</sub>PO<sub>4</sub>, 10mM KCl, 1mM MgSO<sub>4</sub>), 1 M Na<sub>2</sub>CO<sub>3</sub>

1. Prepare reaction mixture. For one sample add 500µl Z buffer, 100µl ONPG, 2.74µl β- mercaptoethanol (one extra for control).
2. Add 600µl of β-gal reaction mixture to a clean 1.5ml eppendorph tube
3. Add 10µl-30µl of supernatant from samples
4. Incubate at 37°C (incubator or water bath) until light yellow colour develops
5. Add 400µl of 1M Na<sub>2</sub>CO<sub>3</sub> to each tube to stop reaction.
6. Measure absorbance of samples at 420nm.

### **Reconstitute CT-1**

Prepare 25 ml of 4 mM HCl, 0.1 % BSA to resuspend CT-1

1. In a 50 ml falcon tube dissolve 0.025 g of BSA in 24.13 ml of ddH<sub>2</sub>O, add 847 µl of 118 mM HCl. Mix solution and filter (0.22 µm pore size) into a new 50 ml falcon tube under sterile conditions.
2. Cool the 4 mM HCl, 0.1% BSA solution (solvent) on ice along with twenty-1.5 ml eppendorph tubes (ten tubes for the solvent and ten for reconstituted CT-1) for 30 min.
3. Add 500 µl of the 4mM, 0.1 % BSA solution to 10 µg of CT-1 (R&D systems, Cat# 438-CT) to obtain a concentration of 20 ng/µl and keep on ice. Allow CT-1 to be completely resuspended in the solvent.
4. Aliquot 50 µl of resuspended CT-1 (20 ng/µl) into ten-1.5 ml eppendorph tubes and 50 µl of solvent into the other ten tubes. Store at -80°C for approximately 3 months or at 4°C for 1 month.

## **ChIP assay and qRT-PCR**

Adaption of EZ ChIP protocol, (Andy Sharocks Lab, modified by Catherine Chan, modified by Stephanie Wales).

### Day 1

#### *Preparation of cross-linked cells, isolation of nuclei, chromatin preparation*

1. Wash plate once with 1X PBS (4°C)
2. Add 10 ml of 1X PBS (4°C) followed by 270 µl of 37% formaldehyde (final 1%)
3. Incubate for 15 min at RT
4. Add 1.25 M glycine (10X stock of glycine) drop wise to plate (final concentration of 0.125 M)
5. Place dishes on ice and remove liquid
6. Wash three times with 1X PBS (4°C), aspirate last wash to remove 1X PBS (4°C)
7. Scrape cells in 1 ml of 1X PBS + inhibitors (4°C)
8. Pellet cells by centrifugation for 5 min at 5000 rpm at 4°C
9. Remove supernatants and resuspend cells with 1 ml of Wash buffer I (10mM HEPES pH 6.5, 0.5 mM EGTA, 10mM EDTA, 0.25% Triton X-100, protease and phosphatase inhibitors)
10. Incubate on ice for 5 min
11. Centrifuge for 5 min at 3000 rpm at 4°C
12. Remove supernatant and resuspend nuclei in 1 ml of Wash buffer 2 (10mM, HEPES pH 6.5, 0.5mM EGTA, 1mM EDTA, 200mM NaCl, protease and phosphatase inhibitors)
13. Incubate for 10 min on ice
14. Centrifuge at 5000 rpm for 5 min at 4°C
15. Remove supernatant. Continue to day 2 or nuclei can be frozen at -80°C

### Day 2

#### *A. Nuclear lysis*

1. Add 250 µl of SDS lysis buffer (50mM Tris-HCl ph 8.1, 1mM EDTA, 1% SDS, protease and phosphatase inhibitors, prepare fresh) to nuclei
2. Sonicate DNA to approximately 250-600 bp fragments

3. Centrifuge samples at max speed for 15 min at 4°C to remove insoluble materials
4. Transfer supernatant to clean tube
  - a. 200 µl aliquot for IP
  - b. Each 400 µl aliquot should have 1 x 10<sup>6</sup> cells
  - c. 2 x 20 µl aliquots for gel and input samples

*B. Pre-Block Protein G Beads*

1. Incubate 15 µl of protein G dynal beads with 20 µg of salmon sperm DNA for each IP in IP dilution buffer
2. 15 µl of beads + 135 µl IP dilution buffer + 20 µg (2 µl of 10 mg/ml) salmon sperm per IP
3. Make 1 extra IP

*C. Lysate-antibody incubation*

1. Once the DNA concentration is known, 25µg per IP is recommended
2. Dilute sample 1:10 with IP dilution buffer (0.01% SDS, 1.1% Triton-X 100, 1.2mM EDTA, 16.7mM Tris-HCl pH 8.1, 167mM NaCl) to 2ml
3. Add 1-2µg of Antibody. Use equivalent amount of IgG control.
4. Rotate at 4°C overnight.

Day 3

*Incubation with Dynalbeads and recovering bound DNA*

1. Add 152µl of pre-blocked beads to each IP reaction. Rotate at 4°C for 1h
2. Using magnet, remove supernatant
3. Wash beads with 1ml of cold IP low salt immune complex wash buffer I (20mM Tris pH 8.1, 2mM EDTA, 150mM NaCl, 1% Triton-X 100, 0.1% SDS)
4. Rotate at 4°C for 5-10min
5. Using magnet, remove supernatant
6. Wash beads with 1ml of cold IP high salt immune complex wash buffer 2 (20mM Tris pH 8.1, 2mM EDTA, 500mM NaCl, 1% Triton-X 100, 0.1% SDS)
7. Rotate at 4°C for 5-10min
8. Using magnet, remove supernatant
9. Elute Protein-DNA complex by adding 300µl of freshly made elution buffer (0.1M NaCO<sub>3</sub>, 1% SDS)
10. Incubate for 30min at room temperature

11. Using a magnet, collect the supernatant in a clean tube
12. To the recovered IP complexes, add 12µl of 5M NaCl
13. Incubate at 65°C overnight

Day 4

#### *DNA purification*

1. Use the qiagen PCR clean up kit, as per manufactures directions
2. The purified DNA can be analyzed or stored at -20°C

#### **Protein Extracts**

**Reagents:** 1XPBS (4°C), Lysis buffer (50 mM Tris, pH 8.0, 150 mM NaCl, 1 mM Sodium vanadate, 1 mM PMSF, protease inhibitor cocktail, Sigma-Aldrich, P-8340), 2X SDS sample buffer (BioRad) (supplemented with β-mercaptoethanol)

1. Pour off media from plates
2. Wash cells 2X with 1X PBS (4°C).
3. Add 700µl of 1X PBS (4°C) and scrape cells in plate.
4. Transfer cell suspension into a 1.5ml eppendorph tube
5. Centrifuge at 1.5 X 1000 G for 5 min at 4°C.
6. Aspirate PBS, and resuspend the pellet with five times (vol/vol) the volume of lysis buffer.
7. Vortex cells briefly, and place on ice, repeat every 5 min for 15 min.
8. Centrifuge cell lysate at 16.1 X 1000 G for 15 min at 4°C, and transfer supernatant to clean 1.5 ml eppendorph tube.
9. Determine protein concentration by Bradford assay.

#### **Harvesting cells**

1. Remove cells from the 37°C incubator and place on ice.
2. Pour off media and wash plates with 10 ml of ice-cold 1x PBS.
3. Add 200- 300 µl of cold 1x PBS each plate and scrape cells from the plates using a rubber scraper. Collect cells (suspended in 1x PBS) into 1.5 ml eppendorph tubes.
4. Spin cells at 4°C at a force of 1500 G for 5 min to pellet the cells. Aspirate the supernatant.
5. Lyse cells using NP-40 lysis buffer (50 mM Tris, 150 mM NaCl, 0.5% NP-40), containing 0.1 M phenylmethylsulfonyl fluoride (PMSF), phosphatase inhibitor cocktail 1 (Sigma, Cat# P 2850) and protease inhibitor cocktail (Sigma, Cat# P 8340) at 1/100 of the total volume.
6. Add NP-40 lysis buffer including inhibitors to each tube at a volume 5x that of the pelleted cells.



7. Vortex cells and place on ice. Repeated three times (once every 5 min for 15 min).
8. Spin lysed cell debris at 4°C at a force of 16 100 G for 15 min. Collect the supernatant into a new 1.5 ml eppendorph tube and stored at -80°C.

### **Bradford Assay**

After collecting the cell lysate, the protein concentration can be determined by the Bradford Assay.

1. Thaw bovine serum album (BSA, 1µg/µl) and protein samples on ice.
2. Label 1.5 ml eppendorph tubes 0, 1, 2, 4, 6, 8 µg/µl for increasing concentrations of BSA and with appropriate sample name.
3. Add 800 µl of ddH<sub>2</sub>O to the 1.5 ml eppendorph tubes.
4. Add the appropriate volume of BSA for the above concentrations to the proper tube and add 2 µl of cell lysate for each sample to the ddH<sub>2</sub>O followed by 200 µl of Bradford reagent (BioRad).
5. Invert tubes to mix the contents and incubate for 5 min at room temperature.
6. Determine optical density (OD) at 595nm for each sample using a spectrophotometer.
7. Generate a standard curve, to determine the sample concentrations.
8. Determine the appropriate volume for 15-20 µg of protein and the correct volumes of 4x sample buffer NP-40 lysis buffer.

### **MF-20 staining for α-MHC**

#### *Fixing the Cells*

1. Aspirate the media from a 35 mm – 6 well plate.
2. Wash cells three times using 3 ml of 1x PBS at room temperature.
3. Incubate cells with 2 ml of ice-cold 90% methanol in ddH<sub>2</sub>O for 6 min at -20°C.
4. Wash cells three times with 3 ml of 1x PBS at room temperature and store at 4°C in 3 ml of 1x PBS.

#### *Primary and Secondary Antibody Incubation*

5. Aspirate the 1x PBS from the wells and blocked cells in 2 ml of 5% non-fat skim milk in 1x PBS for 5 min on the shaker at room temperature followed by 30 min at 37°C.
6. Incubate cells with 1 ml of MF-20 primary antibody diluted 1:20, in 5% non-fat skim milk for 2 h on the shaker at room temperature.
7. Wash cells three times (once every 5 min for 15 min) with 3 ml of 1x PBS with gentle shaking.

8. Incubate cells with the secondary antibody, goat-anti-mouse IgG (H+L)-HRP conjugate (BioRad), diluted 1:1000 in 5% non-fat skim milk in 1x PBS for 1 hr on the shaker at room temperature.
9. Wash cells three times (once every 5 min for 15 min) with 3 ml of 1x PBS.

#### *Preparation of diaminobenzidine (DAB) and staining MHC*

10. Prepare 6 mg of DAB in 10 ml of 1x PBS. Add 30% hydrogen peroxide at 1/1000 of the total volume.
11. Incubate cells with the DAB containing solution for 30 min at room temperature with gentle shaking.
12. Wash cells three times (once every 5 min for 15 min) with 3 ml of 1x PBS, and twice (once every 5 min for 10 min) with 3 ml of distilled water.

#### *Counter-staining Nuclei*

13. Add 1 ml of haematoxylin to each well for 2 min.
14. Wash cells three times (once every 5 min for 15 min) with 3 ml of distilled water.
15. Store cells in 3 ml of distilled water at 4°C.

#### **Nuclear and Cytoplasmic Protein Extracts (NE-PER kit, Pierce)**

1. As per manufactures instructions
2. Scrape cells and pellet by centrifugation at 1 500XG for 5 min at 4 °C.
3. Remove supernatant and add 200 µl of ice-cold CER I to the cell pellet.
4. Vortex the tube for 15 sec and then incubate tube on ice for 10 min.
5. Add 11 µl of ice-cold CER II to the tube.
6. Vortex the tube for 5 sec on the highest setting and then incubate tube on ice for 1 min.
7. Vortex the tube for 5 more sec and then centrifuge at 13 000xg for 5 min at 4°C.
8. Immediately transfer the supernatant (cytoplasmic extract) fraction to a clean pre-chilled tube. Place this tube on ice until use or storage.
9. Re-suspend the insoluble pellet fraction from step 7 in 100 µl of ice-cold NER.
10. Vortex on the highest setting for 15 sec every 10 min for 40 min.
11. Centrifuge the tube at 13 000XG for 10 min at 4 °C and then transfer supernatant to new tube.
12. Determine protein concentration by Bradford assay and analyze samples by Western analysis.

## **SDS-PAGE**

**Reagents:** 1.5M Tris pH 8.8, 30% acrylamide mix, 10% SDS, 10% APS, TEMED, 1X Laemmli buffer.

1. Prepare resolving gel mixture and pour into gel caster
2. After polymerization pour stacking gel and insert combs
3. Fill bottom and centre well of mini-gel apparatus with 1X Laemmli buffer.
4. Load samples on a gel.
5. Run a gel at 100-150 V.

## **Western blotting**

1. Transfer protein from a gel to Immobilon-P (Millipore) membrane by wet transfer at 20 V for 16 hrs or 100 V for 1h (use ice pack).
2. Block membrane with 5 % (w/v) milk in 1X PBS/TBS-T (blocking solution).
3. Incubate membrane with primary antibody diluted in blocking solution for 16 hrs at 4 °C with rocking.
4. Wash membrane with 1X PBS/TBST (3 X 5min each) with rocking.
5. Incubate membrane with secondary antibody in blocking solution for 1-2 hrs at room temperature (RT) with rocking.
6. Wash membrane with PBS/TBST (3 X 5 min each) with rocking.
7. Mix chemiluminescence reagents and add to membrane
8. Incubate for 1min and expose blot to film.
9. Develop (manually or using an automated developer)

## **Immunoprecipitation**

1. Prepare cell lysates as described in protein extracts section.
2. Dilute protein sample in lysis buffer.
3. Incubate 40µl of ImmunoCruz beads with 1-5µg of primary antibody O/N at 4°C with rocking.
4. Spin antibody-matrix complex at max speed for 30sec at 4°C.
5. Remove supernatant
6. Add 1ml of 1X PBS (4°C)
7. Repeat twice more
8. Add 1ml of cell lysate (250-1000µg total protein, make up volume with lysis buffer and inhibitors) to antibody-matrix complex and incubate O/N at 4°C.
9. Pellet immuno-complex by centrifugation at 1000XG for 30 sec
10. Remove supernatant.
11. Wash pellet with 1ml of 1X PBS (4°).
12. Repeat steps 5 and 6 twice more.
13. Re-suspend pellet in 40 µl of 2X SDS sample buffer and boil for 3 min,
14. Load supernatant onto gel (do not transfer beads)

### **CIP treatment**

1. Follow IP protocol until washing
2. Wash with 1X CIP buffer and incubate at
3. Add 1X CIP buffer to tube or 4 $\mu$ l CIP
4. Incubate at 37°C for 30min
5. Wash with 1X CIP buffer
6. Add 4X SDS loading dye
7. Boil at 95°C for 3 min
8. Load sample on SDS-PAGE gel
9. Proceed with Western blotting

### **In vitro kinase assay**

Kinase Assay: Phosphorylation of GST-Fra-2 by p42 MAP Kinase (ERK2)  
p42 MAP kinase (ERK2) (NEB, Cat# P6080S) 100U/ $\mu$ l  
p42 MAP kinase reaction buffer (10X) (50mM Tris-HCl, 10mM MgCl<sub>2</sub>, 2mM DDT, 1mM EGTA, 0.01% Brij 35 (non-ionic detergent). pH 7.5 @ 25°C)  
ATP (10mM)  
[ $\gamma$ <sup>32</sup>-P]ATP  
Myelin Basic Protein (0.5mg/ml) – positive control  
pGEX-4T1 (2T) (GST) – negative control  
pGEX-4T1-Fra-2 (GST-Fra-2)

1. Dilute 10x kinase reaction buffer to 1x
2. Supplement 1x kinase reaction buffer with 200 $\mu$ M ATP and [ $\gamma$ -<sup>32</sup>P]ATP to a final specific activity of 100-500  $\mu$ Ci/ $\mu$ mol
3. Add 2 $\mu$ l (20ng) of purified activated p42 MAP kinase to 8 $\mu$ g of protein
4. Add 10 $\mu$ l of ATP to rxn mixture and mix
5. Incubate reaction mixture for 30 min at 30°C (water bath)
6. Add 2x sample buffer and boil for 5 min
7. Resolve on a 10% SDS-PAGE gel
8. Coomassie stain gel, take pic
9. Dry gel, expose and develop

## **Immunohistochemistry**

**Reagents:** Fixative (90% ice-cold methanol), Blocking reagent (5 % skim-milk in 1XPBS).

1. Wash cells and fix and permeabilize with 90 % methanol for 10 min at -20°C.
2. Block with 5 % skim-milk in 1XPBS at 37 °C for 30 min.
3. Incubate cells with primary antibody for 1 hr in 5 % skim-milk.
4. Incubate cells with Horseradish peroxidase (HRP)-conjugated secondary antibody, 1 hr in 5 % skim-milk 1XPBS.
5. Wash cells three times with 1XPBS and incubated in developer (0.6 mg/ml DAB, 0.1 % H<sub>2</sub>O<sub>2</sub> in 1XPBS).
6. Counter-stain nuclei with haematoxylin.
7. Wash several times in ddH<sub>2</sub>O.
8. Mounting cells with mounting media and cover-slip.

## **RNA Isolation**

As per Qiagen RNeasy kit. See manufactures protocol.

## **Primary single fibre isolation**

### **Stock solutions for fibre culture and staining**

*Collagenase I solution (make fresh), heat to 37°C*

0.02g collagenase I (sigma)/10ml DMEM+  
2ml per mice (2 muscles)

*Fibre isolation media (use at 37°C, keep warm)*

DMEM +  
20% FBS

*Fibre growth media*

DMEM+  
20% FBS  
1% Chick embryo extract (CEE)

*Fibre Differentiation media*

DMEM+  
10% HS

### **Solutions for Fibre Staining**

*Fixation solution*

2% PFA in 1X PBS

*Blocking buffer*

1X PBS  
5% HS or Goat serum  
1% BSA  
0.5% Triton X-100  
0.01% NaAzide

## Primary EDL fibre isolation protocol

1. Sacrifice 6-8 week old male mice (resting or injured)
2. Remove skin from hind limbs
3. Remove the fascia around the hind limb muscle
  - a. cut skin around ankle and cut skin up to knee on the inside and peel up
4. Identify the tendons attaching the TA and EDL to the ankle
5. Cut the tendon from the TA muscle and lift the TA away from the EDL with tweezers
6. Cut the TA proximally near the knee parallel to the EDL to find the other tendon attaching the EDL to the knee joint
7. Cut this tendon to separate the EDL away from the knee
8. Cut the tendon attaching the EDL to the ankle and lift the EDL out of the leg
9. Place the EDL in collagenase I solution and incubate at 37°C for 1h with shaking (until fibres become loose)
  - a. Use a 15ml tube
10. Using flamed-polished wide bore glass pipettes, titurate the muscle until the fibres come loose from the tendon
11. Remove the tendons physically with a narrow opening glass pipette
  - a. Place in 1 well of a 12 well plate (coated with HS)
  - b. Remove chunks of fibres
12. Wash 3 times with warm fibre isolation media (fill the well, wait for fibres to settle, then aspirate the supernatant with the narrow pipette)
  - a. Let fibres settle then pipette from the surface
13. Dispense isolated fibres into HS-coated culture dishes (12-24 well plates)
  - a. 20-30 fibres per well
14. Incubate at 37°C in plates for 20-30min to screen kinks
15. Culture for 42h to observe first division
  - a. 72h to observe transition into myocytes (Myogenin activation)
  - b. 4-5 days for differentiation

## Staining fibres

1. Remove GM and add 1X PBX then Fix in 2% PFA (pre-warmed at 37°C)
  - a. Can store in 1X PBS at 4°C
  - b. Can transfer fibres into clean HS coated plate (can be uncoated)
2. Block using blocking buffer O/N at 4°C or 45min – 1h at RT, with shaking
3. Primary antibody incubation, dilute in blocking buffer, incubate 2h at RT or O/N at 4°C with shaking (300µl/well)
  - a. Pax7 1:2
  - b. Fra-2 1:500
  - c. P-Fra-2 1:200
  - d. C-Jun 1:500
4. Wash with 1X PBS (1-3X)

5. Secondary antibody 1:1000, 1h at RT with shaking (300µl/well)
6. Wash with 1X PBS (1-3X)
7. Dapi, 1:50 000 in PBS for 8 min at RT
8. Wash with 1X PBS (1-3X)
9. Mount onto slides

### **Mounting onto slides**

Use Superfrost Plus slides (fisher) microscope slides white  
Glass covers (22X50)

Hydrophobic pen

1. Mark border of pen with PAP
2. Place all fibres on slide using a wide bore pipette
3. Remove all liquid using a small bore pipette
4. Add 2 drops of Permaflour (Thermo)
5. Remove bubbles
6. Spread out fibres with tweezers
7. Remove excess mounting media
8. Cover slip